

Work Truck Step Installation Instructions for Dodge Pro Master Van

Part No: 501090 / 501097

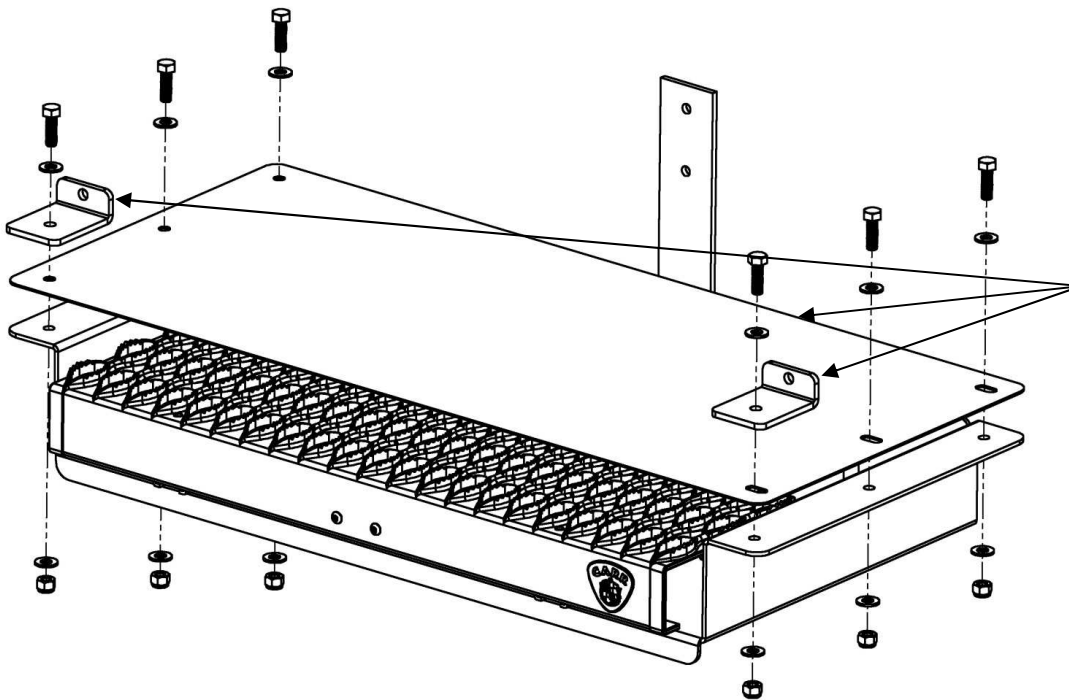

1. Mount the Rear Steel Bracket to the pan with the 5/16" hardware provided and securely tighten them to the pan.

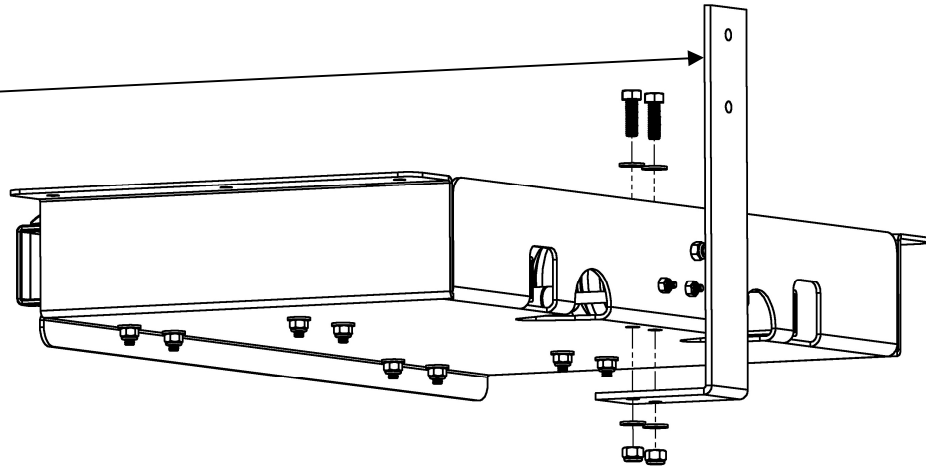

2. Assemble the cover and Front Steel Brackets to the step assembly as shown. Use the 5/16 hardware provided. Make sure the Front Steel Brackets are parallel to the front edge of the cover and not cocked at angle.

3. From underneath your van where the side door is, identify this body metal. Between the two threaded studs is where the Rear Steel Bracket will be mounted. This is our recommendation for the best position of the step. You can move the step to either side of these threaded studs for personal preference location.

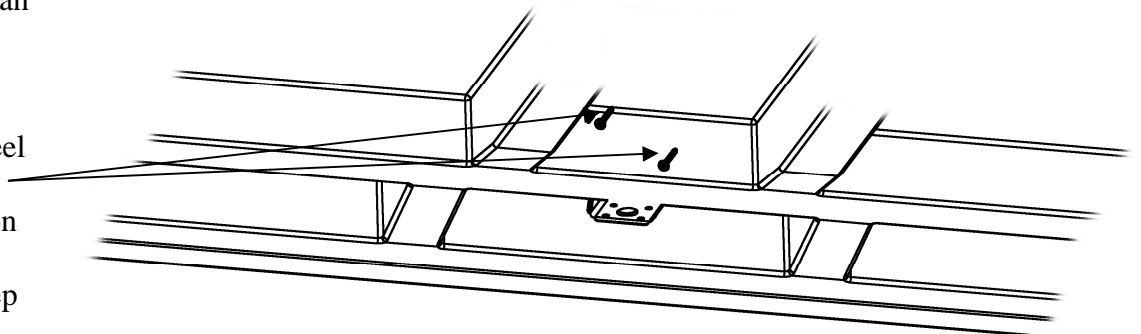

Work Truck Step Installation Instructions for Dodge Pro Master Van

Part No: 501090 / 501097

4. With the step assembly resting on a floor jack or something similar take a pencil or pen and use the holes in the Front Steel Brackets as a guide and mark two holes on the inside surface of the pinch weld.

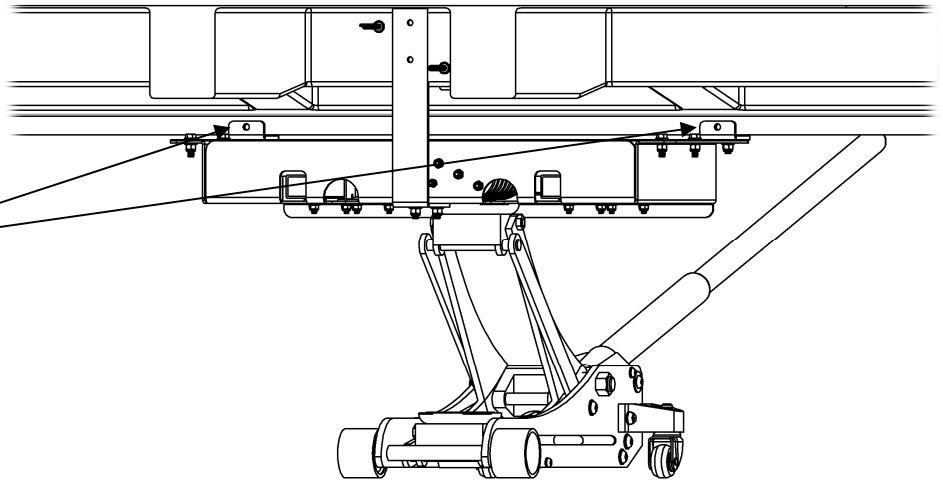

5. Lower the front end of the step down to expose the marked holes. Take a drill motor (a right-angled drill motor will make this easier) with an 11/32" drill bit and drill out the marked holes. Remove all burrs. Lift the step back into position. Take the remaining 5/16" hardware and securely tighten the Front Steel Brackets to the vehicle.

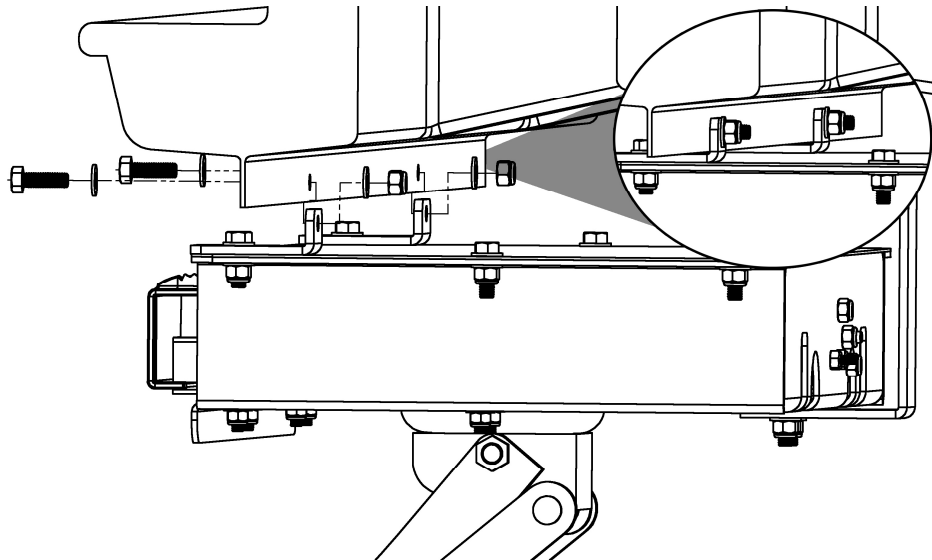

6. Make sure the Rear Steel Bracket is all the way up against the top of the body metal as shown. Take the two 1/4" self-tapping bolts with your drill motor and 7/16" socket and securely tighten these two bolts.

7. Now your step is ready to go. Push the step in with your foot to lock in its closed position. Push it again to deploy it. **We recommend using a garage door opener silicone spray on the rails from time to time to insure smooth operation of the step.**

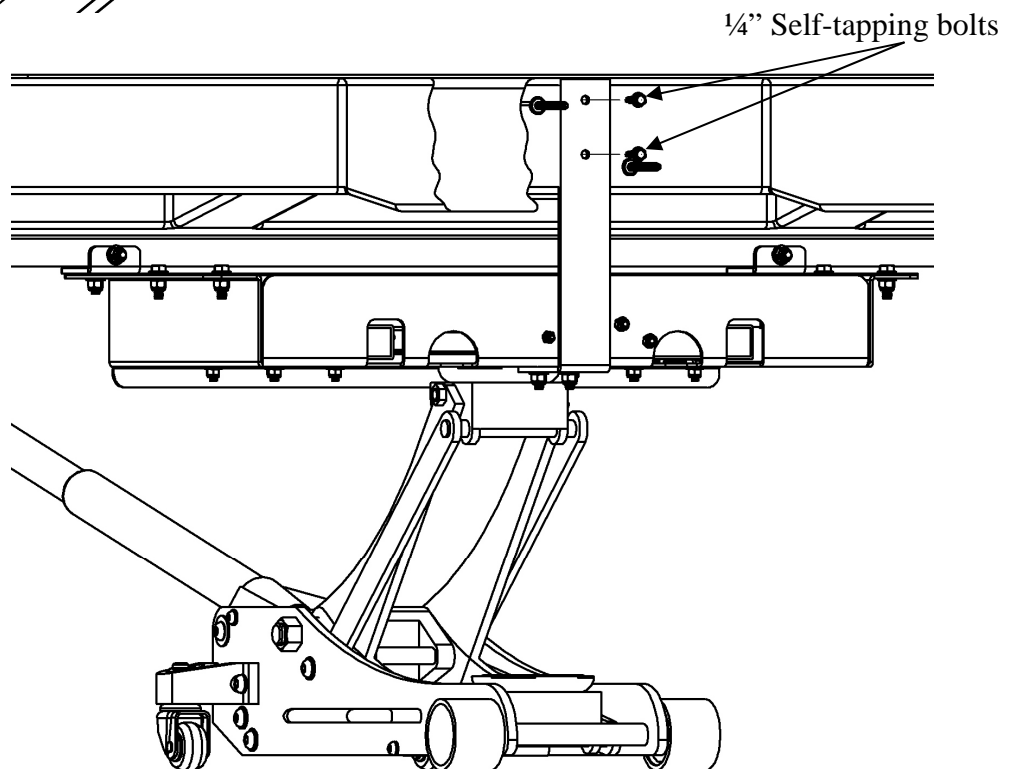

Work Truck Step Installation Instructions for Dodge Pro Master Van

Part No: 501090 / 501097

WARNINGS!

- ✓ FOR SAFE AND PROPER USAGE OF THIS PRODUCT, THE MOUNTING INSTRUCTIONS MUST BE FOLLOWED CAREFULLY AND COMPLETELY.
- ✓ The manufacturer and distributor of this product are in no way responsible for the consumer's failure to adhere to the warnings and directions of these instructions in the event of damage to the consumer's vehicle, other properties and/or personal injury.



Quality and Style that Endures

Follow the diagram and the written directions carefully for a proper, safe installation.

Should you encounter an unusual, unforeseen problem, contact our Technical Help Line
7:00 AM – 3:00 PM Pacific
Time

(800) 800-1084

Visit our web-site at

www.CARR.com

Warranty Information
on our website

Carr Pattern Co., Inc.

Vehicle Application:

'14-20 Pro Master Van Side Door

MAINTENANCE NOTE:

We recommend using a garage door opener silicone spray on the rails from time to time to insure that the step slides in and out easily.

MATERIALS NEEDED:

- * Drill motor (Right angle drill motor is preferred).
- * Impact wrench (if available)
- * 11/32 drill bit
- * Pencil or some marking device
- * 2 – 1/2" wrenches or sockets
- * 1 – 7/16" socket
- * Floor Jack or something similar

MATERIAL FURNISHED:

- * Step Assembly
- * 2 – Front Steel Brackets
- * 1 – Rear Steel Brackets
- * 1 – Cover Plate
- * Hardware installation pack
- * Instruction sheet

Installation time for one step assembly – 45 minutes

Carr Pattern Co., Inc. Warranty Policy

Finishes: Limited Lifetime

Structural Warranty: Limited Lifetime

Warranty Conditions:

- All warranties start from consumer's date of purchase.
- A new product will be sent out immediately to replace a warranty claim.
- The above guidelines apply only to the Original Purchaser.
- Original proof of purchase must be submitted for all warranty and returns issues.

Warranty Limitations:

- Warranty coverage extends ONLY to repair or replacement of the CARR product. This warranty does not cover the cost of labor, transportation, installation or removal of the product.
- Warranty coverage does not extend to damage caused by: collision, fire, theft, freezing, vandalism, riot, explosion or object striking the product, or misuse of the product and/or the vehicle on which the product is being installed.
- Warranty coverage does not extend to damage caused by: airborne fallout (chemicals, tree sap, etc.), stones, hail, earthquake, water or flood, windstorm, lightning, the application of chemicals or sealants subsequent to manufacture.
- Warranty coverage does not extend to damages caused by: normal wear and tear, abuse, modification or improper installation of the product.
- Warranty coverage does not extend to any economic loss or extra expense including (without limitation), payment for the loss of time or pay, inconvenience, storage, loss of vehicle use, vehicle rental expense, equipment rental expense, lodging, meals, or other travel costs.

Other Terms:

This warranty gives you specific legal rights and you may also have other rights that vary from state to state. CARR does not authorize any person to create for it any other obligation or liability in connection with its products. ANY IMPLIED WARRANTY OF MERCHANTABILITY OR FITNESS FOR A PARTICULAR PURPOSE APPLICABLE TO THIS PRODUCT IS LIMITED IN DURATION TO THE DURATION OF THIS WRITTEN WARRANTY. PERFORMANCE OF REPAIRS AND NEEDED ADJUSTMENTS IS THE EXCLUSIVE REMEDY UNDER THIS WRITTEN WARRANTY OR ANY IMPLIED WARRANTY. CARR SHALL NOT BE LIABLE FOR INCIDENTAL OR CONSEQUENTIAL DAMAGES RESULTING FROM BREACH OF THIS WRITTEN WARRANTY.*

*Some states do not allow limitations on how long an implied warranty will last or the exclusion or limitation of incidental or consequential damages, so that above limitations or exclusions may not apply to you.

Guarantee: Every attempt has been made to manufacture and distribute the finest quality products available. Our manufactured products are guaranteed to be free of defects due to workmanship or materials. Distributed products are subject to manufacturer's warranty only.