



INSTALLATION GUIDE

PART NUMBER: 15004
-1" TO -2.75" COILOVER KIT
FORD RANGER | 2019+

300 W. PONTIAC WAY. CLOVIS, CA 93612
PHONE: 800-445-3767 | EMAIL: INFO@BELLTECH.COM

THANK YOU

Thank you for choosing our high quality Belltech product. We have spent a great deal of time developing our line of products so that you will receive maximum performance with minimal difficulty during installation. Soon your vehicle will be on the road looking and feeling much improved.

Please take a moment to read all instructions and warnings prior to installation of your new Belltech product and before operating your vehicle. If you have any questions or concerns regarding any step in the installation process, please do not hesitate to call or email our customer support specialists who are trained to help you through any portion of this process.

Before You Begin:

It is of the utmost importance that you confirm all of the components listed on the parts list is in the kit. You can find this list located on the last page(s) of your instructions. Do not begin installation if any part is missing. Instead, please call our Belltech customer service specialists.

Belltech Customer Support:

Phone: 1-800-445-3767

Email: info@belltech.com

Safety Information:

Warning: Do not work under a vehicle supported only by a jack. Place support stands securely under the vehicle in the manufacturer's specified locations unless otherwise instructed.

Proper use of safety equipment and eye/face/hand protection is absolutely necessary when performing any of the following instructions.

We strive for an exceptional experience for all our valued customers. If for any reason you need assistance with your Belltech products, please do not return the product to the store you purchased from, but rather call our dedicated customer service experts, from 6am to 5pm PST.

We recommend that a qualified mechanic, at a properly equipped facility, perform this installation.

It is very helpful to have an assistant available during installation.

Before Driving Your Vehicle:

It is important to double check all brake hoses, cables, and other components to be sure there is no interference. You must also check for wheel/tire to chassis/body interference. If any issues are found, review your installation instructions to be sure no steps were missed and any problems are corrected.

Make sure your vehicle is aligned immediately following installation.

Check all hardware and re-torque at intervals for the first 10, 100, and 1000 miles.

Some of Belltech's products are designed to improve your vehicle's off-road performance. Leveling/lifting your vehicle may result in an altered center of gravity. It is crucial to use extreme care when operating your vehicle to prevent rollover and/or loss of control.

Any changes in your vehicle's suspension may result in transformed handleability. Please test-drive your vehicle in a remote location so you can become accustomed to the revised driving characteristics.

Perform headlight check and adjustment.

Failure to drive any modified vehicle in a safe manner may result in harm or death.

Never operate your modified vehicle under the influence of drugs, alcohol, or lack of adequate sleep.

Always wear your seatbelt.



DIFFICULTY:

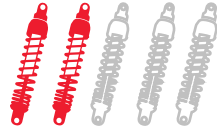

INSTALLATION TIME:

2-4 Hours + Alignment

RECOMMENDED TOOLS:

- Properly rated floor jack
- Support stands
- Wheel chocks
- Metric socket wrench set
- Metric wrench set
- Tape measure
- Marking Pen

SPECIALTY TOOLS:

- High quality spring compressor
- Torque wrench up to 150ft/lbs



Technician note:

Before making any adjustments to your new Belltech coilover, please be sure to loosen the set screw. Failure to do so will damage the threads. After the adjustments are made, you may then tighten the set screw to keep the settings in place.

INSTALLATION PREPARATION:

Before beginning the installation process, measure the hub to fender heights for your vehicle and record them in the “Before” section. After your vehicle has been modified, record the new measurements in the, “After” section. This way, you can compare the resulting height to the original. When taking the measurements, measure vertically from the center of the wheel to the inner edge of the fender.

Before:

LF: _____

RF: _____

LR: _____

RR: _____



After:

LF: _____

RF: _____

LR: _____

RR: _____

JACKING, SUPPORTING, AND PREPARING THE VEHICLE

1. Park your vehicle on a smooth, level, concrete or seasoned asphalt surface.
2. Block the rear wheels of the vehicle using wheel chocks. Make sure the vehicle's transmission is in "PARK" (automatic) or 1st gear (manual).
3. Activate the parking brake.
4. Loosen, but do not remove, the front wheel lug nuts.
5. Lift the front of the vehicle off the ground using a properly rated floor jack. Lift the vehicle so the front tires are approximately 6-8 inches off the ground.
6. Place support stands rated for the vehicles weight. The stands should be positioned in the factory specified locations. (Refer to owners manual). Prior to lowering the vehicle onto stands, make sure the support stands will contact the chassis. It is very important that the vehicle is properly supported to prevent any harm to ones self or to the vehicle.
7. Lower the vehicle slowly onto the stands.
8. Remove the front wheels.



Technician reminder:

Never work under a vehicle supported only by a jack. It is necessary to place support stands securely under the vehicle in the manufacturer's specified locations unless otherwise instructed.

OEM STRUT REMOVAL

9. Using a marking pen, mark the alignment cams to reference placement later.



10. Working on one side at a time, loosen and remove the crossmember bolts that connect the lower control arm and frame.



11. Loosen and remove the nuts securing the lower strut mount to the control arm.



12. Push the spindle and lower control arm down and back until the lower shock studs are clear of the control arm.



OEM STRUT REMOVAL CONTINUED

13. Remove the three nuts securing the top of the strut to the chassis.



STRUT DISASSEMBLY

14. Mount the entire spring/strut assembly in the fixture. To ease the installation of the new strut, mark the position of the top mount in relationship to the upper spring isolator and strut body.
15. Compress the spring until tension is relieved from the strut.



Technician note:

The installation photograph shown was taken at a professional installation shop. It is important to use a spring compressor to compress the spring before removing the top mount bolt. Failure to do so may result in serious injury.

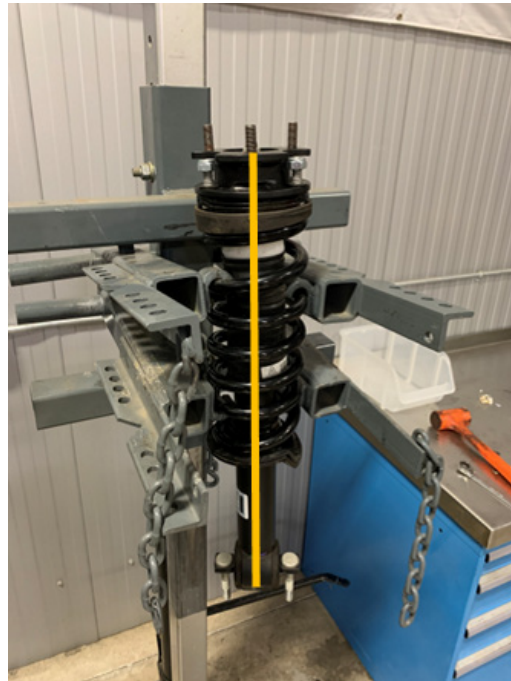

16. Remove top mount. You will use this with your new Belltech coilover later.
17. Remove the spring and strut from the fixture.



BELLTECH COILOVER HEIGHT SETUP AND ASSEMBLY

18. The coilover comes as shown below. Remove the nylock nut from the top of the Belltech coilover.

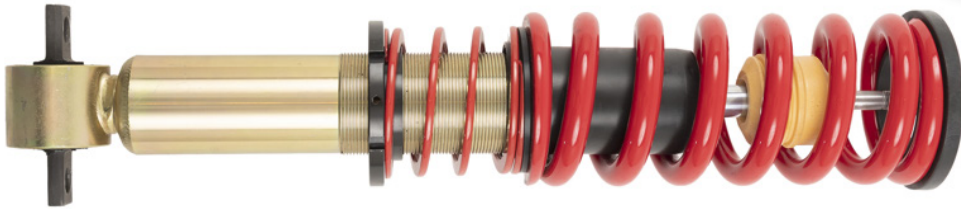

Technician note:

When lowering your Ranger more than -1", OE camber may not be achievable. Ensure proper toe alignment to minimize tire wear.

19. Using the tables below as reference, remove the main spring and slide the required packers onto the strut rod.

2019+ Ford Ranger 2WD/4WD		
Drop (Inches)	Perch height (milli-meters/inches)	15mm Packer
-1	199mm/7.83in	1
-2	177mm/6.96in	0
-2.75	162mm/6.37in	0

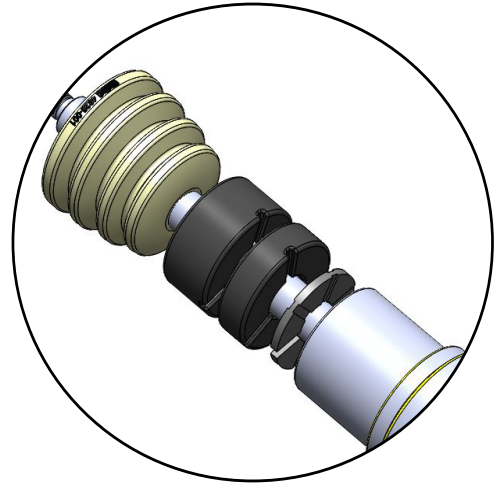

Technician note:

Belltech uses packers to maintain the correct bump stop engagement at various height ranges. Using the appropriate packer will prevent excessive body roll. If a packer is needed, according to the above charts, please place the packer on top of the vent disc, channel side down, as shown by the image to the right of this text box.

20. Confirm the vent desk is located on the strut, under the dust boot. If for any reason your vent disk is not present, please call our technical support staff before proceeding, as driving on the strut without it could cause the shock to fail.

21. Loosen the set screw on the spring perch.

22. Using the provided spanner wrench, turn the bottom spring perch to obtain desired spring perch height, measuring from the top of the perch to the center of the bushing. Find the appropriate spring perch height by referencing the tables above. We do not recommend adjusting beyond what is shown on the tables, as the performance of the shock may decrease greatly.

23. Tighten the set screw.

24. Place the Belltech upper spring seat onto the OE top mount.

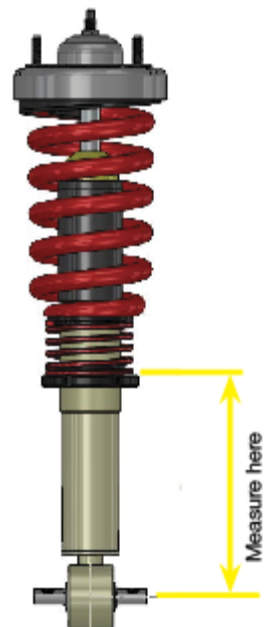
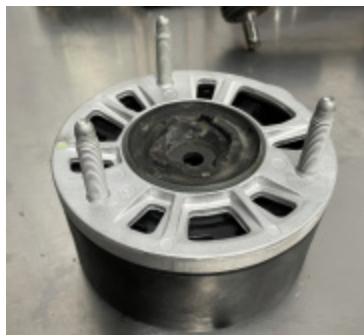

BELLTECH COILOVER HEIGHT SETUP AND ASSEMBLY CONTINUED

25. Assemble the helper spring, intermediate ring, main spring, upper spring seat and OE top mount onto the Belltech coilover.
26. Torque the supplied nylock nut onto the strut. Reference the OE strut markings and ensure the top mount is oriented in the same fashion it was before disassembly.

COILOVER INSTALLATION

27. Install the top mount into the chassis and secure using the OE nuts. Torque the nuts to factory specifications.

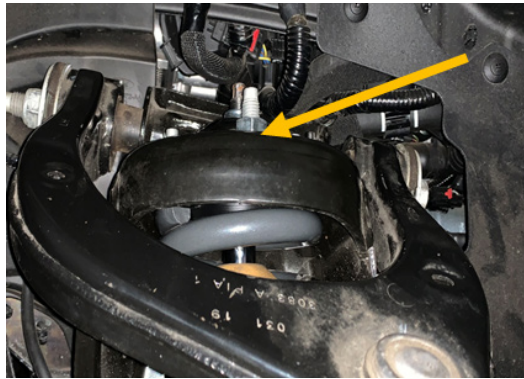

28. Attach the lower strut mount to the lower control arm using the supplied bolts, washers and Nylock nuts. Torque the supplied nuts to 60ft-lbs.
29. Reattach the lower control arm to the frame using the OE alignment hardware. Do not tighten or torque until your vehicle is back on the ground.
30. Set the alignment settings to the markings made before installation.

FINALIZING THE INSTALLATION

31. Re-install the wheels and tighten the lug nuts.
32. Lift the vehicle and remove the support stands.
33. Carefully lower the vehicle onto the flat ground.
34. Torque the lug nuts to manufacturer's specifications.
35. Check that all components and fasteners have been properly installed and torqued.
36. Re-read and perform all tasks in the "Before Driving Your Vehicle" section of page 1 of your instructions.



belltechsuspension



Belltech Suspension



@belltechsuspension

THANK YOU FOR CHOOSING BELLTECH.

You are now a part of the Belltech family and we are eager to catch a glimpse of your newly modified vehicle. Give us a shout out and let us know how much you love our product. Don't forget, we offer other Belltech related merchandise for you and your vehicle on our website, www.belltech.com!

If you have any questions, concerns, or warranty related issues regarding your Belltech product, please call or email our experienced customer service specialists.

Belltech Customer Support:

Phone: 1-800-445-3767

Email: info@belltech.com

KIT CONTENTS



15004		
Part number	Description	Qty
15004-100	Belltech Coilover	2
68510039	Spanner Wrench	1
25007-777	Hardware Kit	2

25007-777 Hardware Kit		
Part number	Description	Qty
112307	Bolt Flanged Hex	2
112308	Flanged Nylock Nut	2

15004-100		
Part number	Description	Qty
15104-003	Top Spring Perch Adapter	1
65210800	Dust Boot	1
15002105	Vent Disc	1
65210799	Bump Stop	1
4935-001	15mm Packer	2
65050018	Spring Perch	1
15000-003	Intermediate Ring	1
60140122	Helper Spring	1
68320103	Set Screw M5x12	1
15004-245	Threaded Damper	1
70110-260-993	Linear Spring	1