



**BLUE OX®**

Baseplate Installation Instructions

BX1014

# 2004-06 Acura TL Installation Instructions

Serial Number

**Please read BOTH these Installation Instructions and the General Instructions before attempting to install or operate this equipment.**

- Blue Ox® towing products and accessories are intended to be installed by Blue Ox® Dealers who are familiar with our products and have the equipment necessary and knowledge to do "fit work". When necessary Blue Ox® Dealers can be found at [www.blueox.us](http://www.blueox.us) or by contacting our Customer Care Department at (402) 385-3051 or toll free (888) 425-5382.
- Many Blue Ox® Baseplates are designed to use existing holes and hardware to mount the baseplate to the towed vehicle. Even though bolts are there, do not assume they are adequate for baseplate mounting. Always use hardware supplied in the hardware kit and existing hardware specified in the Baseplate Installation Instructions.

Attachment Tab Height: 13.5"

Attachment Tab Width: 27"

### Bolt Torque Specifications

Torque in Foot-Pounds per Metric Bolts

Bolt Size	Grade 8.8	Grade 10.9
6MM	6	8
8MM	16	22
10MM	31	40
12MM	54	70
14MM	89	117

Confirm the towability and pre-towing procedures for your vehicle with the owner's manual or contact the vehicle's manufacturer for specific towing procedures. You can also contact REMCO for additional information at 1(800)228-2481.

### Bolt Torque Specifications

Torque in Foot-Pounds per Inch Bolts

Bolt Size	Grade 5	Grade 8
1/4"	10	14
5/16"	19	29
3/8"	33	47
7/16"	54	78
1/2"	78	119
5/8"	154	230

## WARNING

Failure to read and follow these instructions could result in separation of the towed vehicle from the tow bar, causing property damage, loss of towed vehicle, personal injury or death.

# BX1014

# 2004-06 Acura TL

## Installation Instructions

### Parts List

Ref. No.	Qty.	Part #	Description
1	1	61-6051	Weldment, Baseplate, BX1014
2	1	61-5288	Driver's Side, 1/2" Nut Plate
3	1	61-5289	Passenger's Side, 1/2" Nut Plate
4	4	201-0051	1/2-13 x 1 1/2" Bolt, Grd. 5, ZP
5	4	203-0012	1/2" Lock Washer, ZP
6	4	201-0443	3/8-16 x 1" Bolt, Grd. 5, ZP
7	4	203-0010	3/8" Lock Washer, ZP
8	4	202-0003	3/8-16 Hex Nut, ZP
9	1	101-6692	Electrical Bracket, 25 Degr.
10	2	201-0050	1/4-20 x 3/4" Bolt, Grd. 5, ZP
11	2	203-0008	1/4" Lock Washer, ZP
12	2	202-0069	1/4-20 Hex Whiz, Lock Nut, ZP
13	2	201-0192	#10-32 x 1/2" Slot, Rd. Hd. Screw
14	2	203-0054	#10 Lock Washer
15	2	202-0047	#10-32 Hex Nut
16	2	101-5822	Adapter, 4 Way Connector
17	2	201-0654	#10-16 x 1" Self Drilling Screw
18	2	62-3468	Attachment, Assembly, SF/SB (R)
	2	226-0046	Baseplate Safety Cable, 36" CL III (Not Shown)
	2	229-0359	Quicklink, 3/8, ZP (Not Shown)
	2	290-0437	Cap Plug, Black (Not Shown)

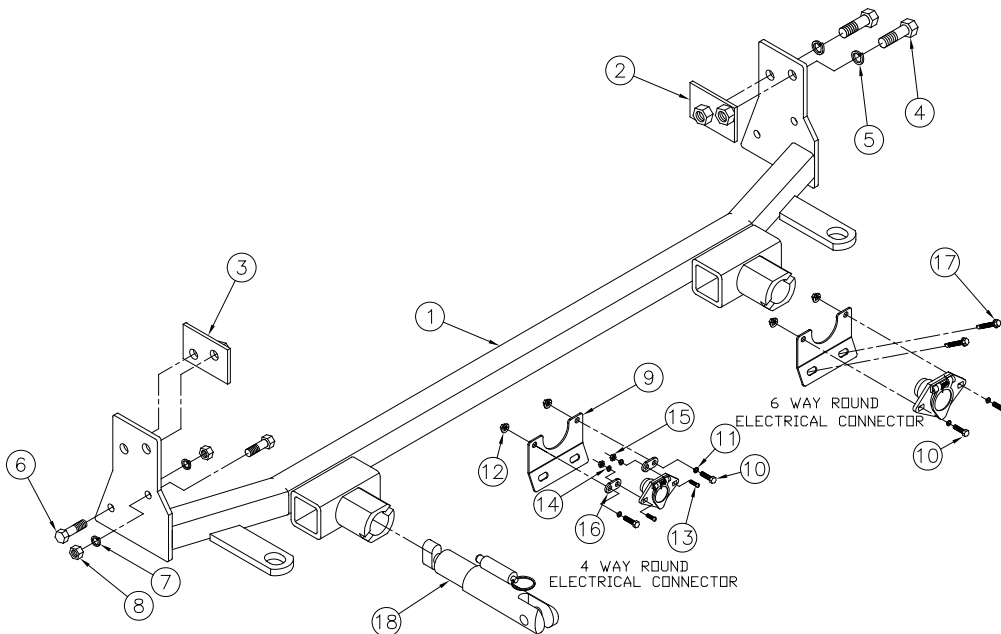

### Tools Required

- 10MM Socket
- 12MM Socket
- 9/16" Socket
- 3/4" Socket
- 13/32" Drill Bit
- 17/32" Drill Bit
- Phillips Screw Driver
- Flat Screw Driver
- Side Cutter
- Vise Grips
- LOCTITE Red

### Important:

Use only genuine factory replacement parts on your baseplate. Do NOT substitute homemade or non-typical parts. If a bolt is lost or in need of replacement, for your safety and the preservation of your baseplate, be sure to use a replacement bolt of the same grade (In most cases it will be Grade 5, please reference the parts list above). Replacement parts may be ordered through your nearest Blue Ox® Dealer or Distributor, or call our 24/7 Customer Care Team at (402)385-3051.

BX1014  
**2004-06 Acura TL**  
Installation Instructions

## Removable Tabs:

Due to the design of the removable tabs, the RangeFinder II and Ambassador tow bars can not be used. Adapters, except the BX8833 and BX88151, can not be used with this baseplate.

## Instructions:

The front fascia and metal bumper are removed and reinstalled for the baseplate installation. Drilling is required. Trimming of the fascia is required.

The dimensional variations between otherwise identical vehicles can be considerable. While the baseplate was designed for easy installation, it may be necessary to tailor the baseplate slightly to compensate for auto manufacturer's tolerances. These minor adjustments may include filing a hole slightly, bending electrical rods, and/ or bending end plates.

The BX8848 4 Diode Wiring Kit is recommended for this vehicle.

## Installation Instructions

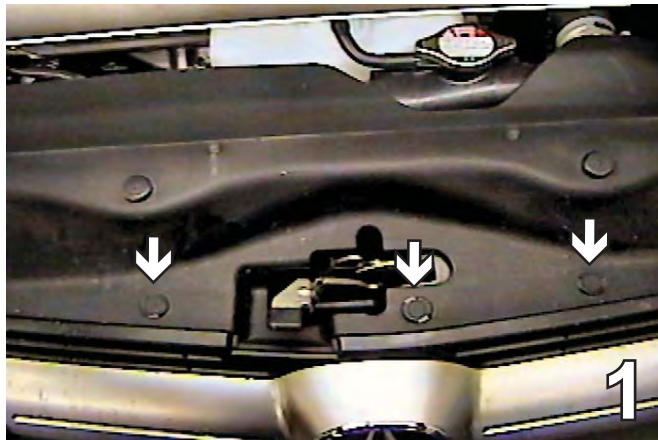

1. Just forward of the hood latch are three pushpins to remove from the top of the fascia. Set push pins aside to be reinstalled later.



2. Remove one pushpin outside of the hood bumper. Do this to both sides of the vehicle. Lift up the black plastic cover from top side of the fascia and set aside.

BX1014  
2004-06 Acura TL  
Installation Instructions

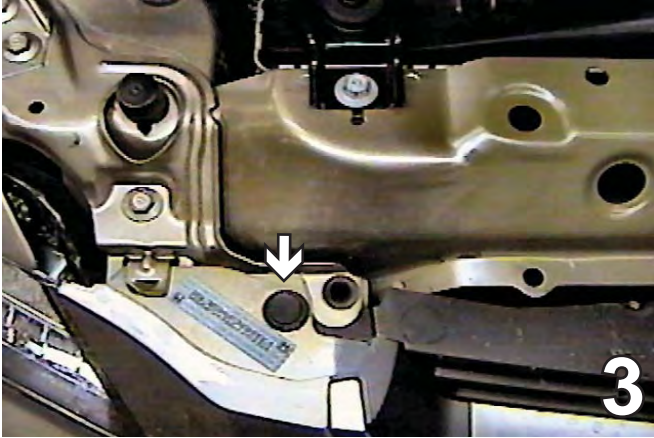

3. Remove the pushpin from the top edge of the fascia just inside of the headlight assembly. Do this to both sides of the vehicle.



4. Just forward of the front tire are two pushpins to remove. Do this to both sides of the vehicle.



5. Pull wheel well cover away from the fascia edge and remove the Phillips screw from the fascia's corner with the Phillips screwdriver. Do this to both sides of the vehicle.



6. Just forward of front tire is one metric bolt to remove with the 10MM socket and one push pin. Do this to both sides of the vehicle.



BX1014  
**2004-06 Acura TL**  
Installation Instructions



7. Remove two push pins from the lower edge of the front fascia, just below the license plate. Set bolts aside to be reinstalled later.



8. Just below the cross member radiator support are two metric bolts to remove with the 10MM socket. Do this to both sides of the vehicle. Set bolts aside to be reinstalled later.

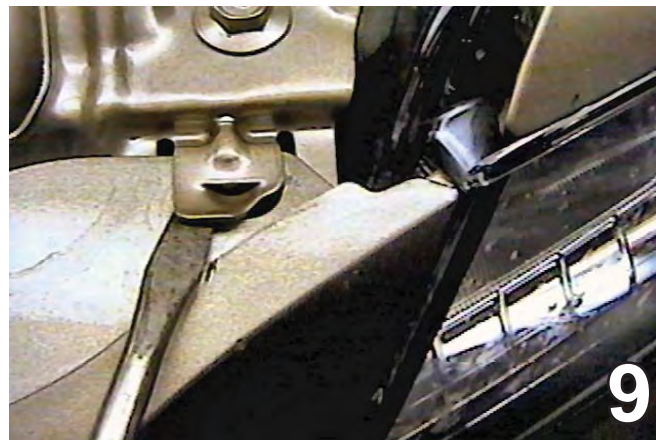

9. Using the flat screwdriver, pry up tab on the top edge of the fascia just inside of headlight assembly. Do this to both sides of the vehicle. Pull fascia's corners out to the side of the vehicle, pry fascia forward just below headlight assemblies with the flat screwdriver, pull fascia forward and set aside to be reinstalled later.

BX1014  
2004-06 Acura TL  
Installation Instructions

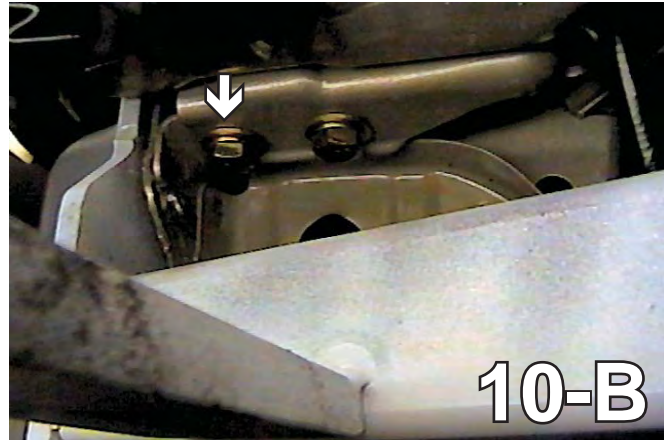
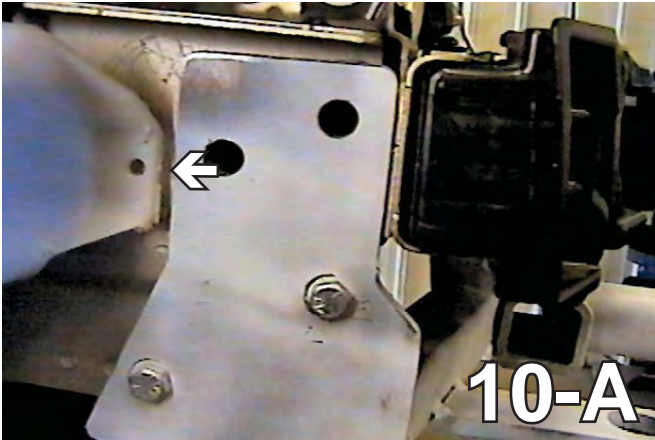

10. Slide the baseplate end on to frame as far forward as possible and 1/4" below webbing on the top edge of the frame rail and clamp vise grips to lower webbing. Do this to both sides of the vehicle. It may be necessary to trim off the front edge of the reservoir with the side cutters to open area for baseplate. Using the baseplate as a template, drill the top two holes with the 17/32" drill bit. Do this to both sides of the vehicle. Then drill the two lower holes with the 13/32" drill bit. Do this to both sides of the vehicle. Remove the outside lower metric bolt from the metal bumper on the passenger's side with the 12MM socket, as indicated by the white arrow in 10-B. Insert the 3/8" metric bolts into the lower holes of the baseplate, tighten the 3/8" hex nuts and lock washer, as indicated in graphics on page #2. Do this on both sides of the vehicle. **Be sure to use LOCTITE Red on ALL bolts. Torque ALL bolts according to the torque spec chart on the front of this document.** The Baseplate is painted white for illustrative purposes only. The actual baseplate will have a powder coat black finish.

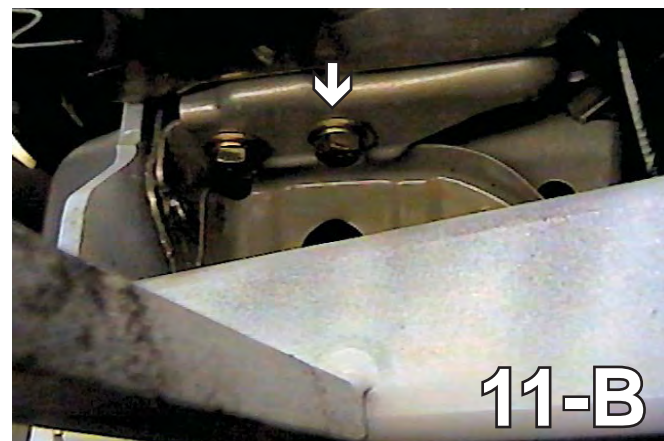
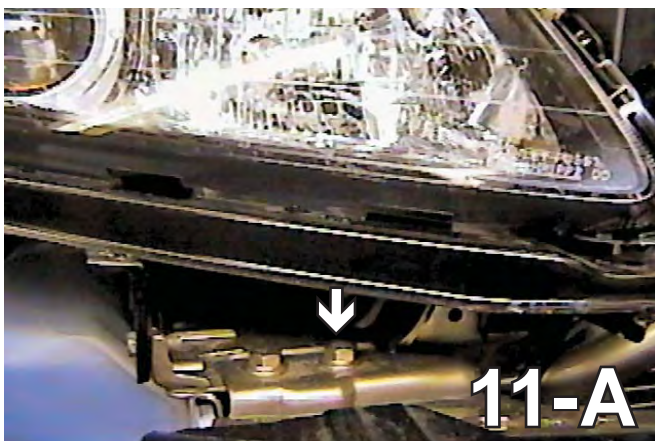

11. Using the 12MM socket, remove the two metric bolts from the top side and one from the lower side of the metal bumper just below the headlight assembly. Do this to both sides of the vehicle. Pull metal bumper forward. Set bolts and metal bumper aside to be reinstalled later.



BX1014  
2004-06 Acura TL  
Installation Instructions

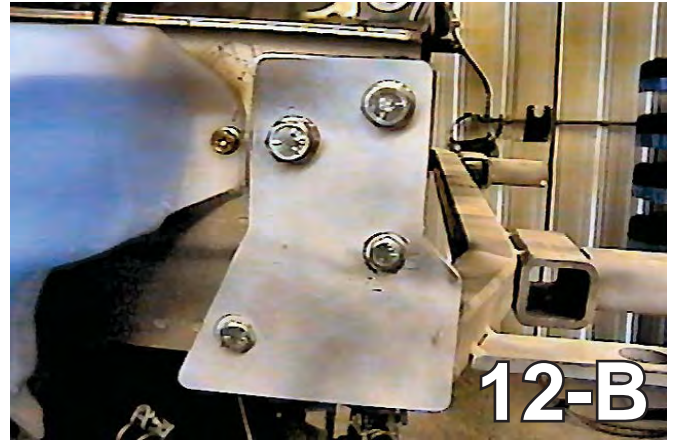
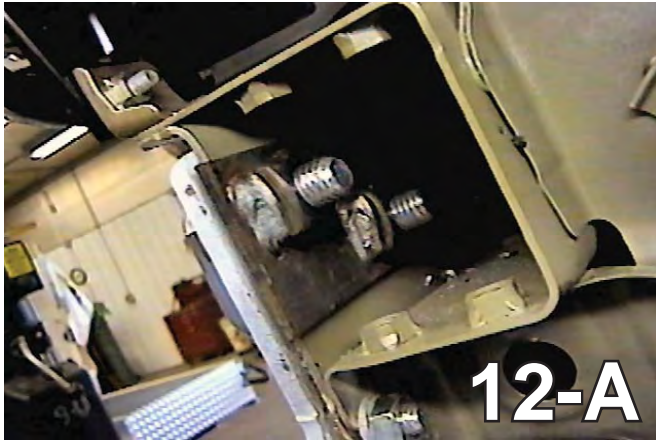

12. Level the baseplate with the vehicle, insert the 1/2" nut plate into the frame to align with the upper drilled holes on the passenger's side. Insert the 1/2" hex bolts and lock washer into baseplate, tighten into nut plate with the 3/4" socket. Align the nut plate with the upper drilled holes on the driver's side, tighten the 1/2" hex bolts and lock washers into nut plate. **Be sure to apply LOCTITE Red to ALL bolts before tightening. Torque ALL bolts according to the torque chart on the front page of this document.**



13. Reinstall the metal bumper and existing metric bolts with the 12MM socket. **NOTE: outside metric bolt on passenger's side will not be used.**

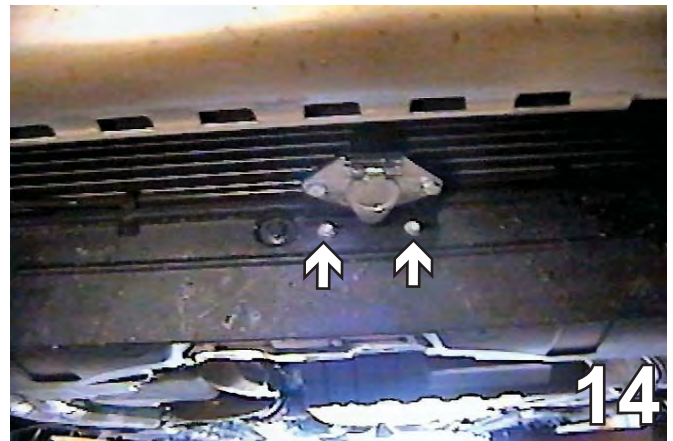

14. Using the two self tapping screws, install the electrical bracket just below the fascia on radiator cross member as shown in the photo above.

BX1014  
2004-06 Acura TL  
Installation Instructions



15. Hold the fascia as close to its original position as possible, trim the lower grille to allow attachment receivers to come through the lower grille and reinstall the fascia. Passenger's side is shown.

Install the tow bar and safety cables according to the instructions included in their packages.

Do not substitute other devices if the tow bar pin and clip are lost.

**DEALER OR INSTALLER: BE CERTAIN THE USER RECEIVES THE INSTRUCTION SHEET.**

### CUSTOMER SERVICE COMMITMENT

Blue Ox is committed to providing you with exceptional customer care throughout your lifetime with our products. Our team is here to assist you with any questions you may have regarding the performance of your product. Simply call 1-800-228-9289 and you can speak with our customer care team.

Additionally, please visit our website to see which rallies our Destination America team will be attending. For a nominal fee, our service technician will service your towing system to ensure it's in proper working condition. Also as a commitment to our customers, should you visit our factory you can stay at our full service Blue Ox campground at no charge along with enjoying a factory tour.

Again thank you for being our customer and for the confidence you have shown in the performance of our products. It is because of customers like you we enjoy the success we have today.



© 2005, 06, 07, 08 Blue Ox  
One Mill Road, Industrial Park  
Pender, Nebraska 68047  
Phone: (402) 385-3051  
Toll Free: (888) 425-5382  
Fax: (402) 385-3360  
[www.blueox.us](http://www.blueox.us)