



BLUE OX®

Baseplate Installation Instructions

BX1969

2005-07 Chrysler Town & Country Installation Instructions

Serial Number

Please read BOTH these Installation Instructions and the General Instructions before attempting to install or operate this equipment.

1. Blue Ox® towing products and accessories are intended to be installed by Blue Ox® Dealers who are familiar with our products and have the equipment necessary and knowledge to do "fit work". When necessary Blue Ox® Dealers can be found at www.blueox.com or by contacting our Customer Care Department at (402) 385-3051 or toll free (888) 425-5382.
2. Many Blue Ox® Baseplates are designed to use existing holes and hardware to mount the baseplate to the towed vehicle. Even though bolts are there, do not assume they are adequate for baseplate mounting. Always use hardware supplied in the hardware kit and existing hardware specified in the Baseplate Installation Instructions.

Attachment Tab Height: 14"

Attachment Tab Width: 18"

Bolt Torque Specifications

Torque in Foot-Pounds for Metric Bolts

Bolt Size	Grade 8.8	Grade 10.9
6MM	6	8
8MM	16	22
10MM	31	40
12MM	54	70
14MM	89	117

Confirm the towability and pre-towing procedures for your vehicle with the owner's manual or contact the vehicle's manufacturer for specific towing procedures.

Bolt Torque Specifications

Torque in Foot-Pounds for Inch Bolts

Bolt Size	Grade 5	Grade 8
1/4"	10	14
5/16"	19	29
3/8"	33	47
7/16"	54	78
1/2"	78	119
5/8"	154	230



! WARNING

Failure to read and follow these instructions could result in separation of the towed vehicle from the tow bar, causing property damage, loss of towed vehicle, personal injury or death.

BX1969 2005-07 Chrysler Town & Country Installation Instructions

Parts List

Ref. No.	Qty.	Part #	Description
1	1	61-6015	WELDMENT, BASEPLATE, BX1969
2	2	61-3799	WELDMENT, NUT PLATE, BX3301
3	4	201-0655	6MM-1.0 X 30MM HEX BOLT, GRD8.8,ZP
4	8	201-0440	3/8-16 X 1 1/2 HEX BOLT, GRD.5, ZP
5	8	203-0010	3/8 LOCK WASHER, ZP
6	8	202-0003	3/8-16 HEX NUT, ZP
7	2	201-0153	1/2-13 X 2 1/2 HEX BOLT GRD.5, ZP
8	2	203-0012	1/2 LOCK WASHER, ZP
9	2	201-0553	1/4-20 X 1/2 HX.WSHD.TYPE F TCS, ZP
10	2	201-0192	10-32 X 1/2 SLOT, RD. HD. SCREW
11	2	203-0054	#10 LOCK WASHER
12	2	202-0047	#10-32 HEX NUT
13	2	101-5822	ADAPTER, 4 WAY CONNECTOR
14	2	62-3468	ATT TAB ASSY, REM, SF/SB, 1 HOLE
	2	290-0437	RECEIVER, CAP PLUG (BLK) (NOT SHOWN)
	2	229-0359	QUICKLINK, 3/8, ZP (NOT SHOWN)
	2	226-0046	BASEPLATE SAFETY CABLE, 36" CL III (NS)

Tools Required

8MM Socket
 10MM Socket
 9/16" Socket
 8MM Wrench
 13/32" Drill Bit
 17/32" Drill Bit
 Phillips Screw Driver
 Diagonal Cutters
 Utility Knife
 LOCTITE Red

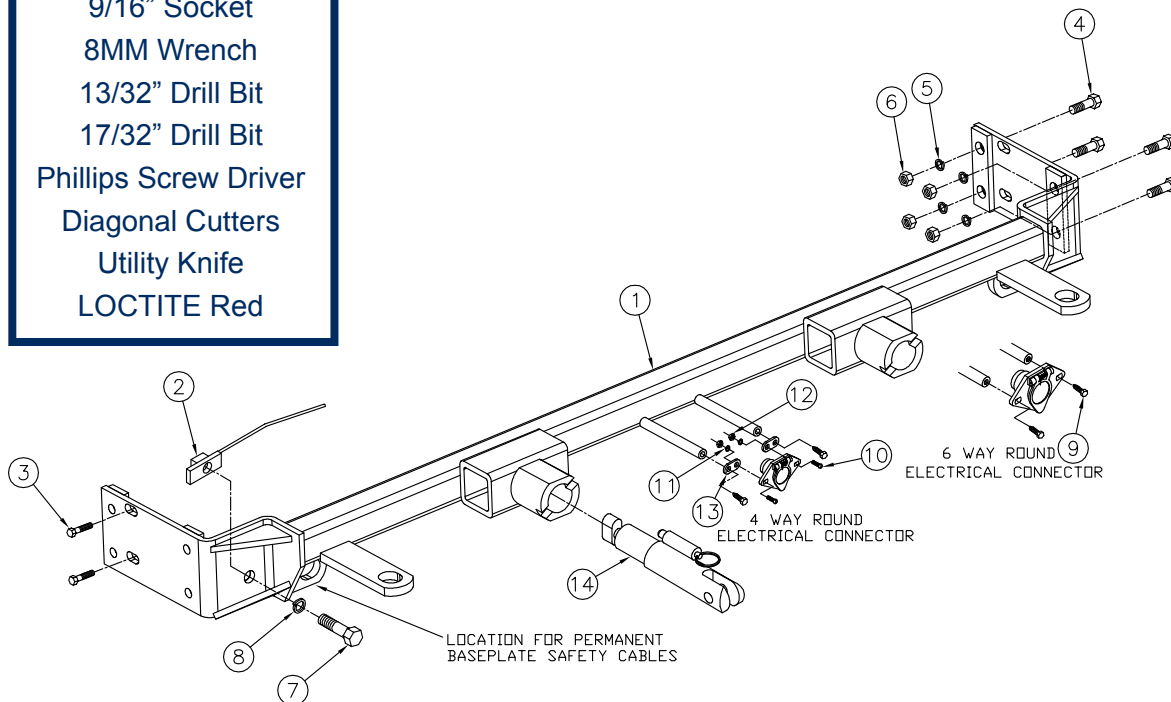

Important:

Use only genuine factory replacement parts on your baseplate. Do NOT substitute homemade or non-typical parts. If a bolt is lost or in need of replacement, for your safety and the preservation of your baseplate, be sure to use a replacement bolt of the same grade (In most cases it will be Grade 5, please reference the parts list above). Replacement parts may be ordered through your nearest Blue Ox® Dealer or Distributor, or call our Customer Care Team at (402)385-3051.

BX1969

2005-07 Chrysler Town & Country

Installation Instructions

Removable Tab:

Motorhome mount tow bars are recommended for use with this baseplate. Due to the design of the removable tabs, the RangeFinder II, Adventurer, and Ambassador tow bars can not be used. The Acclaim tow bar may be used, but will not fold and store on the front of the vehicle. Adapters, except the BX8833 and the BX88151, can not be used with this baseplate.

Instructions:

The front fascia and sensors are removed and reinstalled for the baseplate installation. Drilling is required. Factory tow hooks must be removed and will remain off the vehicle after installation.

The dimensional variations between otherwise identical vehicles can be considerable. While the baseplate was designed for easy installation, it may be necessary to tailor the baseplate slightly to compensate for auto manufacturer's tolerances. These minor adjustments may include filing a hole slightly, bending electrical rods, and/ or bending end plates.

The BX8869, Bulb and Socket Wiring Kit is recommended for this vehicle.

Installation Instructions

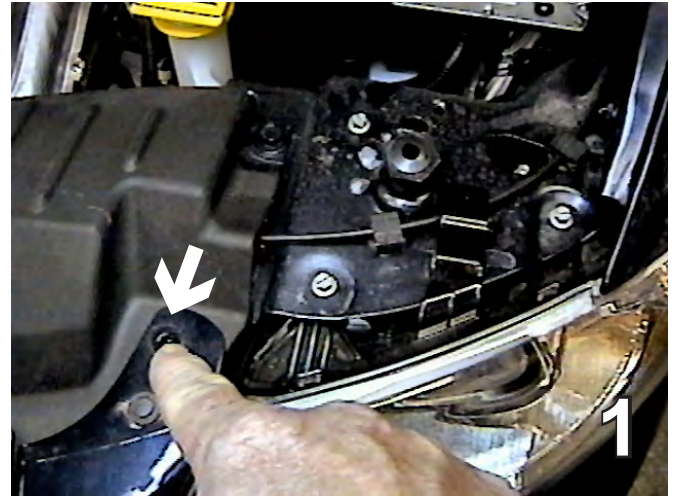

1. Remove one metric bolt just between headlight assemblies on top edge of fascia, with the 10MM socket, both sides.

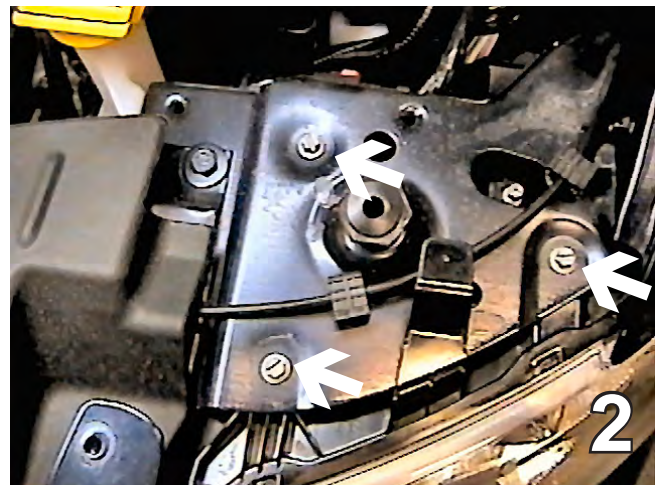

2. Remove three metric bolts from headlight assembly with the 8MM socket, pull forward, unplug electrical and set aside, both sides.

BX1969

2005-07 Chrysler Town & Country

Installation Instructions

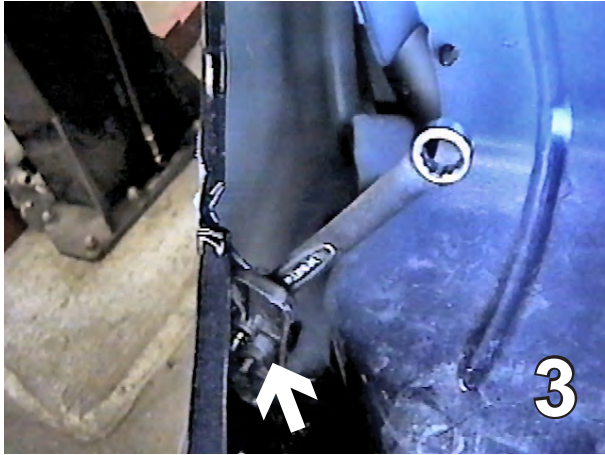

3. Just behind headlight assembly is one metric bolt to remove with the 8MM socket or wrench, both sides.

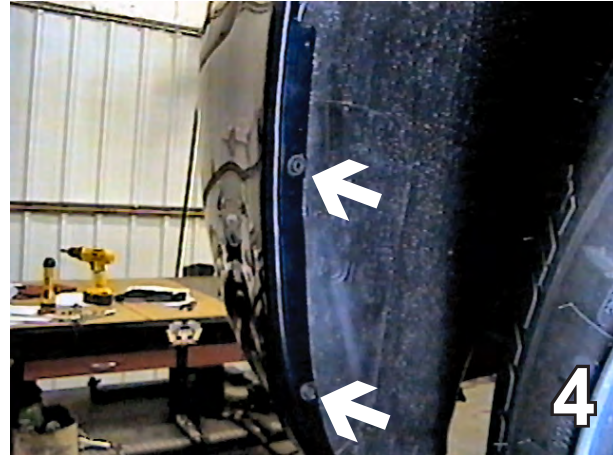

4. Forward of front tires are two screws to remove from wheel well edge with the Phillips screw driver, both sides.

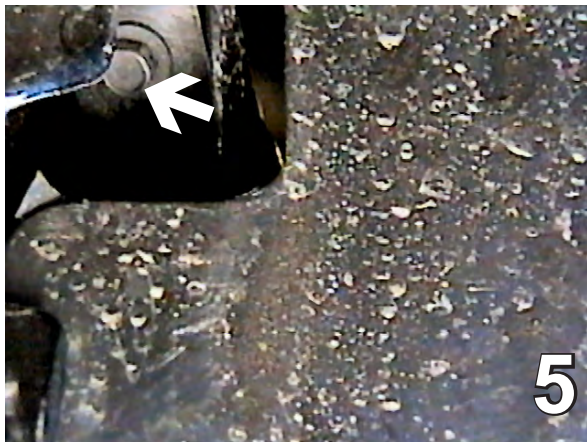

5. Remove the one metric bolt just forward of the front tire, on fascia's corner, using the 8MM socket, both sides.

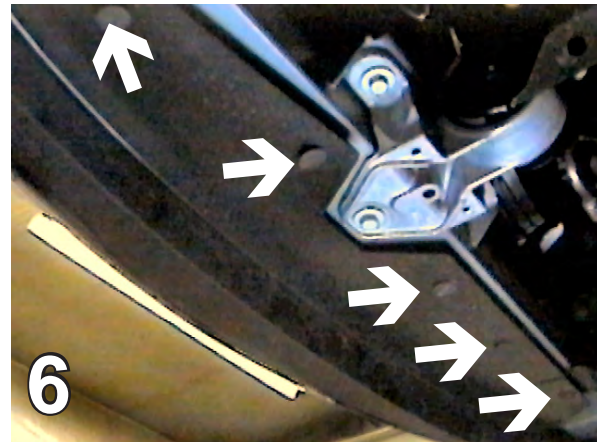

6. Remove five christmas tree push pins from lower edge of fascia next to motor mount. Pull fascia forward, unplug electrical connection to fog lights (available with some models) and set aside.

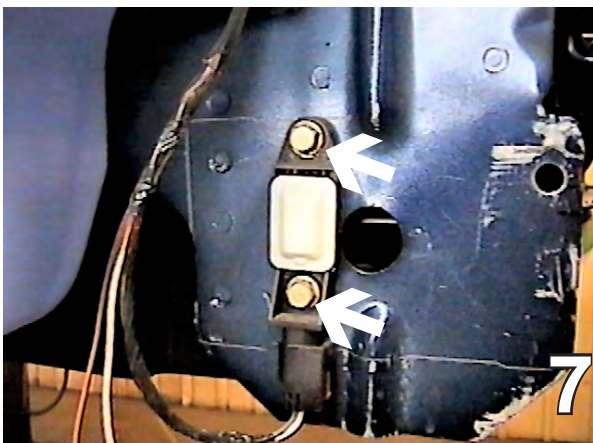

7. Using the 10MM socket, remove two metric bolts from the air bag sensor, both sides and tie up out the way.

BX1969
2005-07 Chrysler Town & Country
Installation Instructions

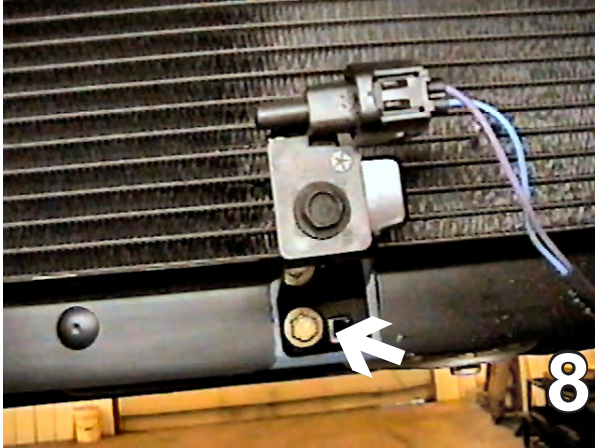

8. Remove one metric bolt from the temperature sensor using the 10MM socket and set out of the way.

Note: Some models may be equipped with an air dam that will need to be removed and trimmed after installing baseplate.

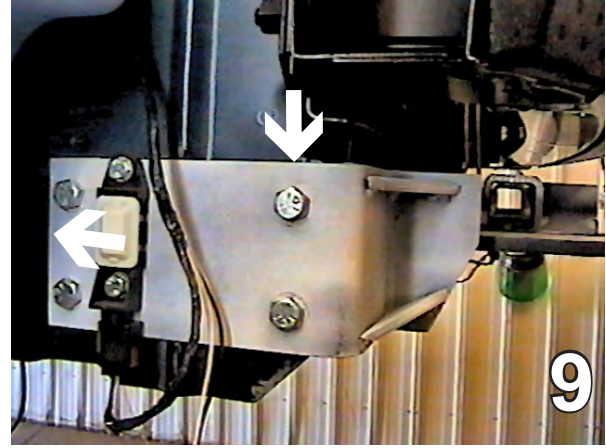

9. Align back and top edge of baseplate even with the webbing on the lower frame and clamp in place. Obround holes on baseplate end need to be aligned with existing air bag sensor hole locations. Be sure baseplate is level. Drill the four holes in the webbing with the 13/32" drill bit, both sides.

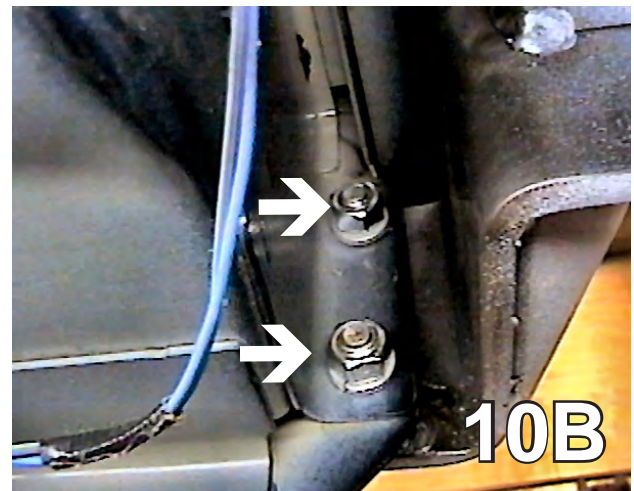
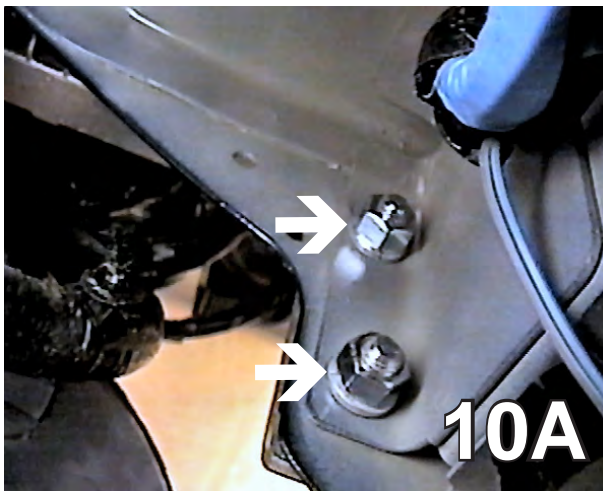

10. Insert the 3/8 x 1 1/2" hex bolts into baseplate and drilled holes, tighten 3/8" lock washer and hex nut on the back side of webbing with the 9/16" socket, both sides. **Be sure and use Loctite on all bolts before tightening. Tighten all bolts according to Torque Chart in the General Instruction Sheet.**

BE SURE TO USE LOCTITE® RED ON ALL BOLTS BEFORE TIGHTENING. TIGHTEN ALL BOLTS ACCORDING TO THE TORQUE CHART ON THE FRONT PAGE OF THESE INSTRUCTIONS OR ON PAGE 3 OF THE BASEPLATE TOWING GENERAL INSTRUCTIONS.

BX1969
2005-07 Chrysler Town & Country
Installation Instructions

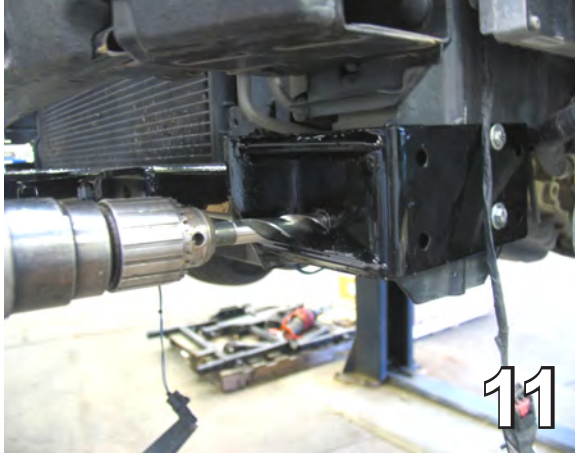

11. Using the 17/32" drill bit, drill the hole in the front of the baseplate using the baseplate as a template. Do this to both sides.



12. Drill 1 1/4" with hole saw into bottom of cross member. Do this to both sides.

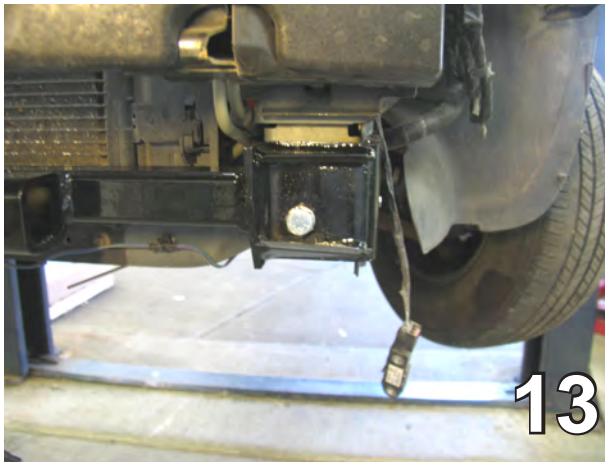

13. Insert the 1/2" nut plate into the hole on the bottom of the frame cross member to align with the drilled hole and tighten the 1/2-13 x 2 1/2" hex bolt with a lock washer. Do this on both sides.

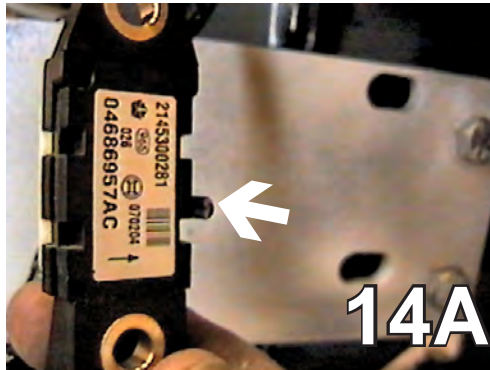

15. Reinstall temperature sensor, fascia, and headlight assemblies. **Be sure all electrical connections are plugged in properly. Some models may require trimming of the fascia.**

14. Using the diagonal cutters, cut off the alignment pin on the sensor and reinstall the sensor to its original position through obround

16. The dimensional variations between otherwise identical cars can be considerable. While the location and size of the holes in the baseplate were designed to allow for easy installation, it may be necessary to file a hole slightly to allow a bolt to clear.

17. Install the tow bar and safety cables according to the instructions included in their packages.

18. Do **not** substitute other devices if the tow bar pin and clip are lost.

BX1969 2005-07 Chrysler Town & Country Installation Instructions

Be sure that **ALL** electrical connections are plugged in properly and functioning **BEFORE** installing the fascia.

Install the tow bar and safety cables according to the instructions included in their packages.

Do not substitute other devices if the tow bar pin and clip are lost.

DEALER OR INSTALLER: BE CERTAIN THE USER RECEIVES THE INSTRUCTION SHEETS.



Possible Location for the BX8869 Bulb and Socket Wiring Kit.



Shown with Removable Tabs Installed.

DEALER or INSTALLER:

Be certain the user receives the instruction sheets for their products.

CUSTOMER SERVICE COMMITMENT

Blue Ox is committed to providing you with exceptional customer care throughout your lifetime with our products. Our team is here to assist you with any questions you may have regarding the performance of your product. Simply call 1-800-228-9289 and you can speak with our customer care team.

Additionally, please visit our website to see which rallies our Destination America team will be attending. For a nominal fee, our service technician will service your towing system to ensure it's in proper working condition. Also as a commitment to our customers, should you visit our factory you can stay at our full service Blue Ox campground at no charge along with enjoying a factory tour.

Again thank you for being our customer and for the confidence you have shown in the performance of our products. It is because of customers like you we enjoy the success we have today.



© 2005, 07, 08, 09 Blue Ox
One Mill Road, Industrial Park
Pender, Nebraska 68047
Phone: (402) 385-3051
Toll Free: (888) 425-5382
Fax: (402) 385-3360
www.blueox.com
6/23/11