



BX1994

2011-2013 Chrysler Town & Country LMT 2011-2013 Dodge Caravan (Includes Grand) Installation Instructions

Serial Number

Please read BOTH these Installation Instructions and the General Towing Instructions before attempting to install or operate this equipment.

- Blue Ox® towing products and accessories are intended to be installed by Blue Ox® Dealers who are familiar with our products and have the equipment and knowledge to do “fit work.” When necessary, Blue Ox® Dealers can be found at www.blueox.com or by contacting our Customer Care Department at (402) 385-3051.
- Many Blue Ox® baseplates are designed to use existing holes and hardware to mount the baseplate to the towed vehicle. Even though bolts are there, do not assume they are adequate for baseplate mounting. Always use hardware supplied in the hardware kit or existing hardware specified in the Baseplate Towing Installation Instructions.

Attachment Tab Height: 15”
Attachment Tab Width: 24”

Bolt Torque Specifications
Torque in Foot-Pounds for Metric Bolts

Bolt Size	Grade 8.8	Grade 10.9
6MM	6	8
8MM	16	22
10MM	31	40
12MM	54	70
14MM	89	117

Confirm the towability and pre-towing procedures for your vehicle with the owner’s manual or contact the vehicle’s manufacturer for specific towing procedures.

Bolt Torque Specifications
Torque in Foot-Pounds for Inch Bolts

Bolt Size	Grade 5	Grade 8
1/4”	10	14
5/16”	19	29
3/8”	33	47
7/16”	54	78
1/2”	78	119
5/8”	154	230



If the front of your vehicle looks different than this, call us at (402) 385-3051.

⚠ WARNING

Failure to read and follow these instructions could result in separation of the towed vehicle from the tow bar, causing property damage, loss of towed vehicle, personal injury or death.



BX1994

2011-2013 Chrysler Town & Country LMT 2011-2013 Dodge Caravan (Includes Grand) Installation Instructions

Parts List

Ref. No.	Qty.	Part #	Description
1	1	61-6857	WLDM'T, BP, BX1994
2	12	201-0368	3/8-16 X 1 1/4 HEX HEAD BOLT,GRD. 5
3	12	202-0090	3/8-16 HEX NYL. INS. LOCK NUT, ZP
4	2	201-0553	1/4-20 X 1/2 HX.WSHD.TYPE F TCS, ZP
5	2	201-0192	10-32 X 1/2 SLOT, RD. HD. SCREW
6	2	203-0054	#10 LOCK WASHER
7	2	202-0047	#10-32 HEX NUT
8	2	101-5822	ADAPTER, 4 WAY CONNECTOR
9	2	62-3468	ATT TAB ASSY, REM, SF/SB, 1 HOLE
10	1	102-7168	BREAKAWAY BRKT, BX1994
11	1	201-0050	1/4-20 X 3/4 HEX BOLT GRD.5, ZP
12	1	201-0781	1/4-20 X 2 1/4 HEX BOLT, GRD. 5, ZP
13	2	202-0102	1/4-20 HEX NYL NUT, ZP
	2	226-0049	BASEPLATE SAFETY CABLE, 36" CL IV (Not Shown)
	2	290-0437	RECEIVER, CAP PLUG (BLK) (Not Shown)
	2	229-0512	QUICKLINK, 1/2, ZP (Not Shown)

Tools Required

10MM Socket	Utility Knife
7/16" Socket/Wrench	Torque Wrench
9/16" Socket/Wrench	Tape Measure
Large Vise Grip	Drill
Reciprocating Saw	1/4" Drill Bit
Flat Screwdriver	13/32" Drill Bit
Phillips Screwdriver	Loctite® RED

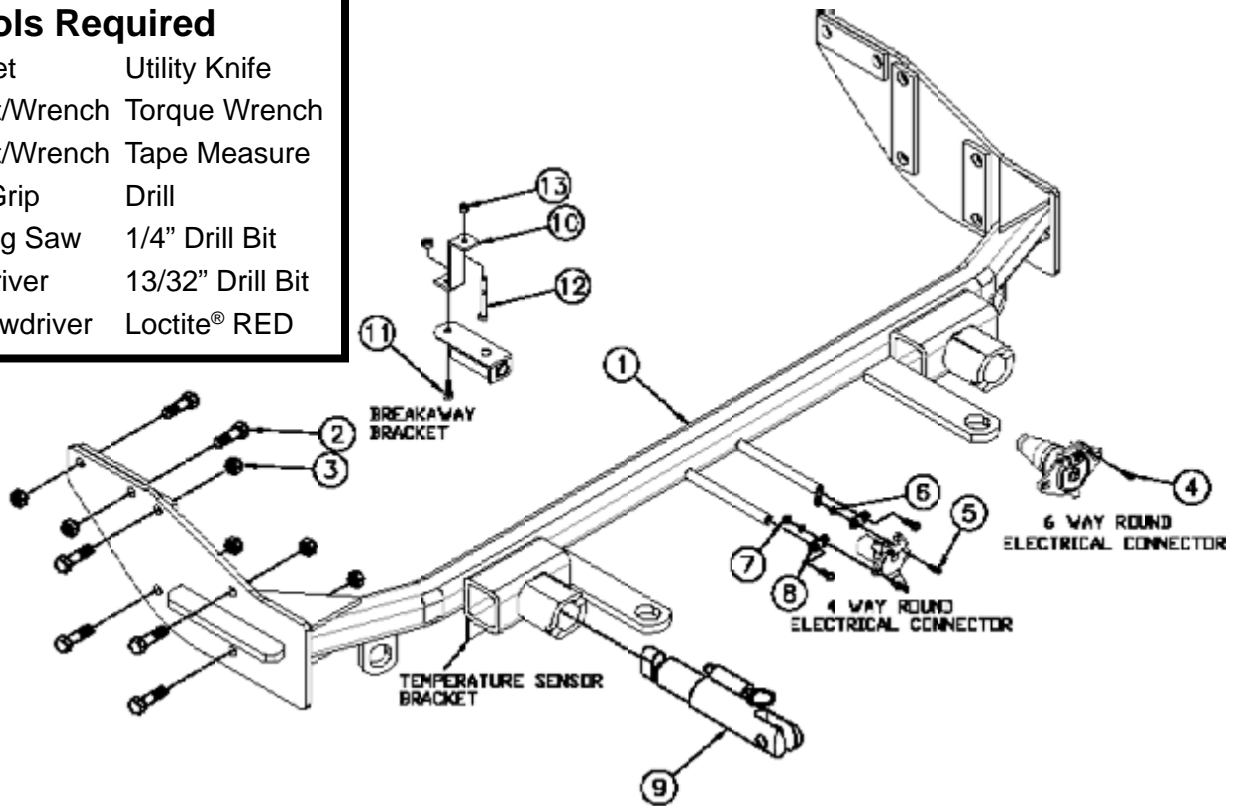

Important:

Use only genuine factory replacement parts on your baseplate. Do **NOT** substitute homemade or non-typical parts. If a bolt is lost or in need of replacement, for your safety and the preservation of your baseplate, be sure to use a replacement bolt of the same grade (In most cases it will be Grade 5, please reference the parts list above). Replacement parts may be ordered through your nearest Blue Ox® Dealer or Distributor. Failing to follow and/or altering these installation instructions in either installation or required equipment will void the manufacturer's warranty.



BX1994

2011-2013 Chrysler Town & Country LMT 2011-2013 Dodge Caravan (Includes Grand) Installation Instructions

Vehicle Weight: Due to the design of the removable tabs, the RangeFinder II tow bar can not be used. Adapters, except the BX8833 and BX88151, can not be used with this baseplate.

Installation Notes: The fascia, temperature sensor, computer and washer reservoir are removed and reinstalled during installation of the baseplate. Drilling is required. Trimming is required.

The dimensional variations between otherwise identical vehicles can be considerable. While the baseplate was designed for easy installation, it may be necessary to tailor the baseplate slightly to compensate for auto manufacturer's tolerances. These minor adjustments may include filing a hole slightly, bending electrical rods or bending end plates.

The BX8848, 4 Diode wiring kit is recommended for this vehicle.

Handling of some cosmetic parts when installing this product may require the use of protective covers, rags, specialty tools, etc. to prevent damage.

Installation Instructions



1. Using a 10MM socket remove the bolt above the headlight. Using a flat screwdriver remove the push pin. Do this to both sides and set bolts and push pins aside for later reinstallation.



2. Using a Phillips screwdriver, remove two (2) screws just forward of the front tire on the wheel well. Do this to both sides of the vehicle. Set the screws aside to be reinstalled later.



BX1994

2011-2013 Chrysler Town & Country LMT 2011-2013 Dodge Caravan (Includes Grand) Installation Instructions



3. Continuing just forward of the front tire on the wheel well, using a 10MM socket, remove the bolt in the corner. Do to both sides and set bolt aside for later reinstallation.



4. On the driver side only in front of the tire, use a flat screwdriver to remove the push pin. Set the pin aside for later reinstallation.



5. Using a flat screwdriver, remove four (4) push pins from underneath the front edge of the fascia. Set push pins aside to be reinstalled later.



6. Be sure to unplug the fog lights. The corner of the fascia is then pulled out to the side and forward to remove. Set fascia aside carefully to be reinstalled later.



BX1994

2011-2013 Chrysler Town & Country LMT 2011-2013 Dodge Caravan (Includes Grand) Installation Instructions

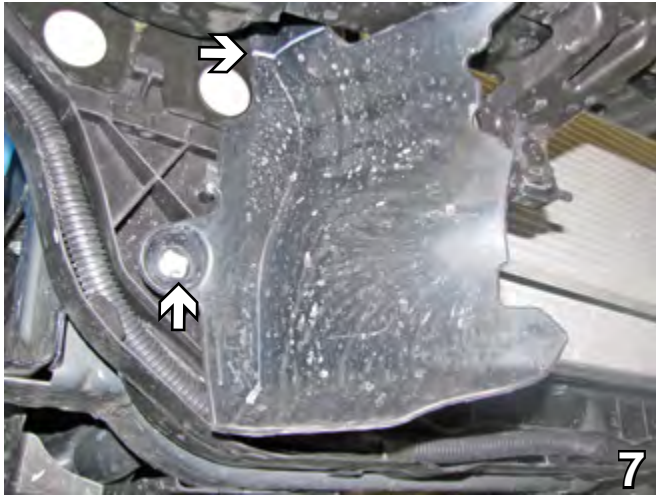

7. Using a utility knife, cut the plastic along the bottom of the bumper. Then using a flat screwdriver, remove the push pin. Do this to both sides. This section will not be reinstalled.

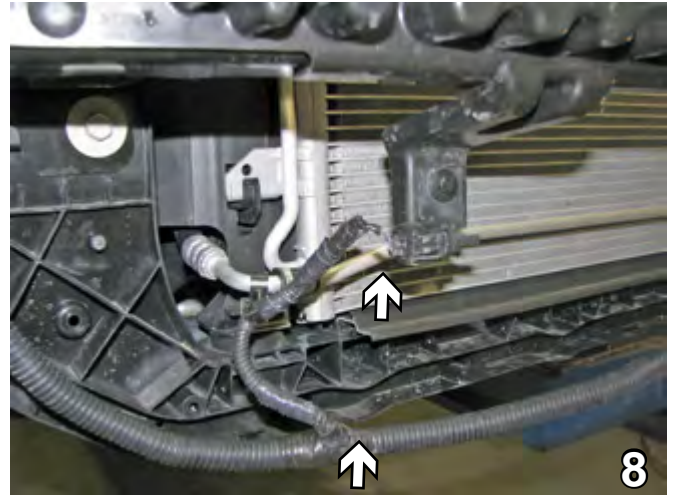

8. On the passenger side, unclip the temperature sensor cord and unplug the sensor. Lay it over the top of the bumper.

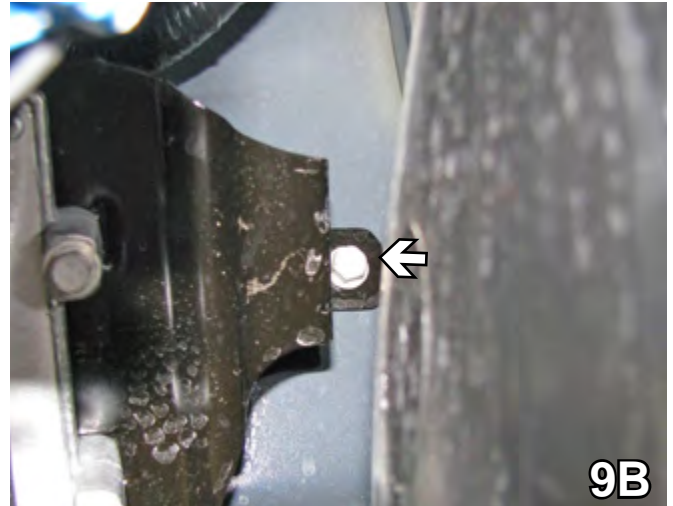
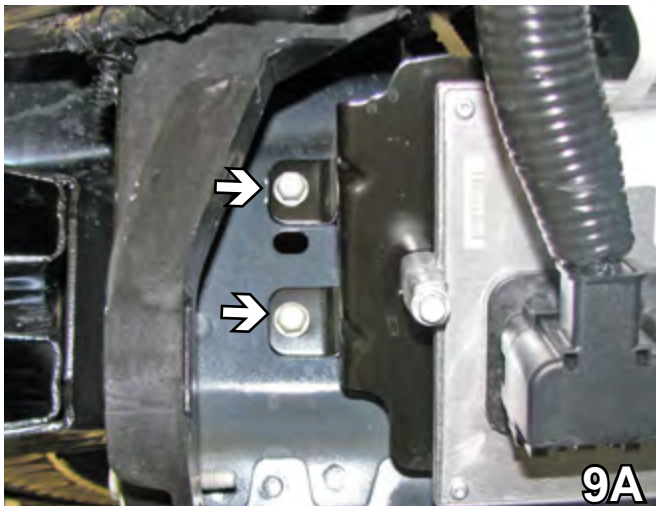

9. On the driver's side right behind the bumper, using a 10MM socket remove two (2) bolts on the front and one on the back then let the computer hang down in order to do drilling. Set bolts aside to be reinstalled later.



BX1994

2011-2013 Chrysler Town & Country LMT 2011-2013 Dodge Caravan (Includes Grand) Installation Instructions

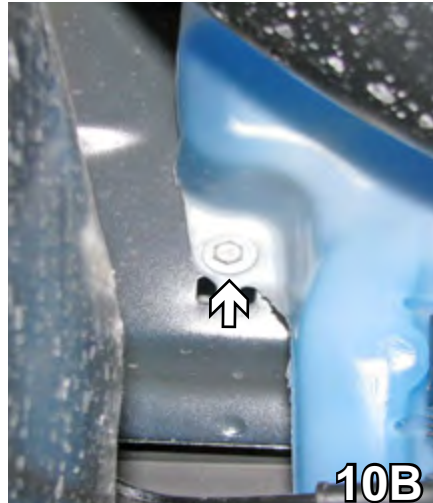

10. On the passenger side, using a 10MM socket, remove the two (2) bolts one on each side of the washer reservoir. Unplug the electrical plug and take the water lines off the washer reservoir, mark and plug them. Set washer reservoir and bolts aside to be reinstalled later.

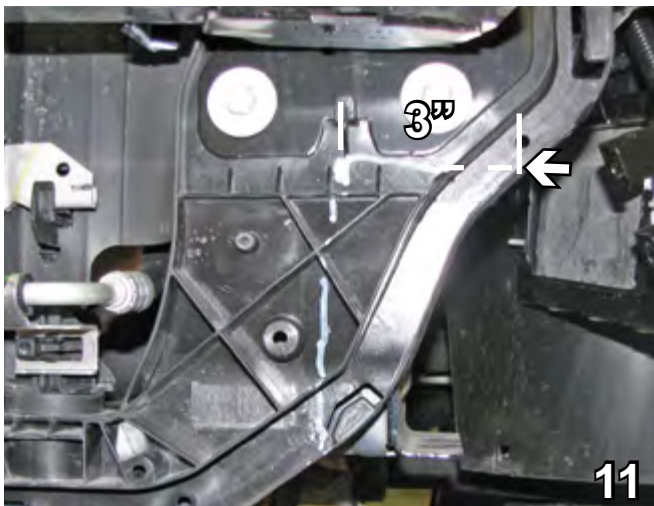

11. Using a reciprocating saw, cut straight across right along side the bottom of the plate 3" and straight down at a 90° angle. (Flush with the lower frame extension and just behind the plastic.) Do this on both sides.

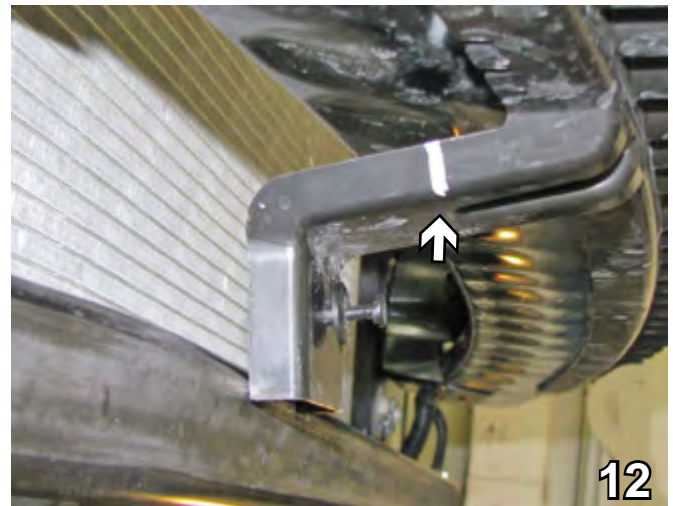

12. On the passenger side, cut off the bracket which held the temperature sensor. The temperature sensor will be relocated.



BX1994

2011-2013 Chrysler Town & Country LMT 2011-2013 Dodge Caravan (Includes Grand) Installation Instructions



13. On the backside of the fascia in the fog light area on the outer edge of the grille top opening, cut 1/2" in and straight to the side down to the first level. Do this on both sides.

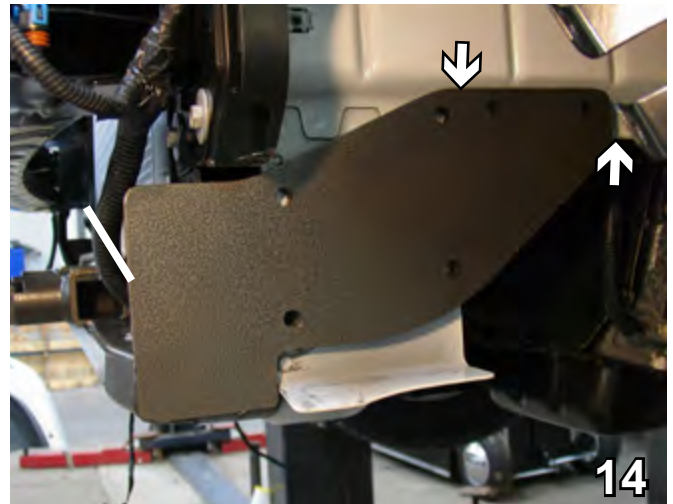

14. Slide the baseplate up where we cut and back as far as it will go. Be sure the baseplate is level and clamp in place.

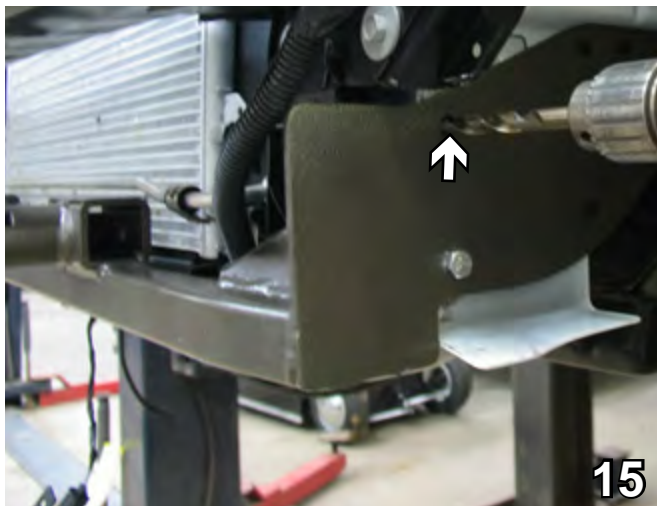

15. Using the baseplate as a template, drill six (6) holes with a 13/32" drill bit.



16. On the passenger's side, the top two (2) bolts are brought from the inside out because of the black plastic shield. All the same 3/8"-16 x 1-1/4" hex bolts and 3/8"-16 hex nuts are used. Be sure to use Loctite Red on ALL bolts.

BE SURE TO USE LOCTITE® RED ON ALL BOLTS BEFORE TIGHTENING. TIGHTEN ALL BOLTS ACCORDING TO THE TORQUE CHART ON THE FRONT PAGE OF THESE INSTRUCTIONS OR ON PAGE 3 OF THE BASEPLATE TOWING GENERAL INSTRUCTIONS.



BX1994

2011-2013 Chrysler Town & Country LMT 2011-2013 Dodge Caravan (Includes Grand) Installation Instructions

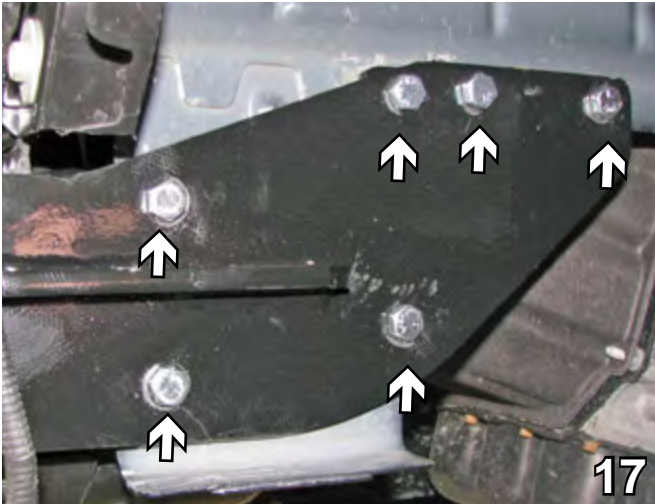

17. On the driver's side, mount the baseplate using 3/8"-16 x 1-1/4" hex bolts going in and 3/8-16 hex nuts. Be sure to use Loctite Red on ALL bolts.

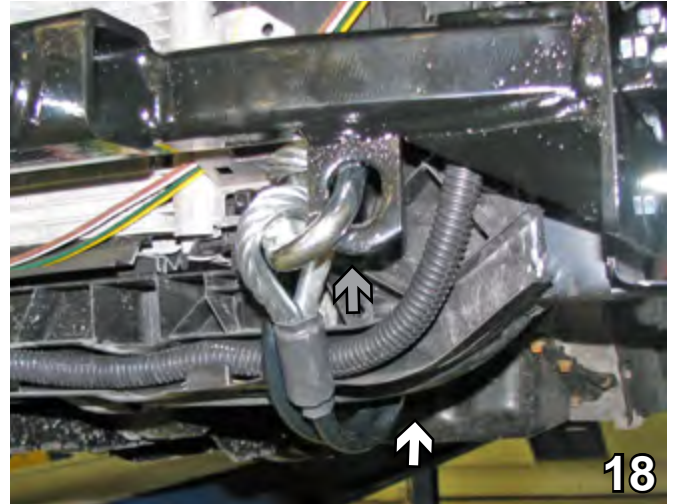

18. Attach the permanent baseplate safety cables to the provided convenience link on the baseplate (gray arrow). The photo above shows the recommended installation of the cables to frame of vehicle (see white arrow). Additional options may interfere with suggested mounting; in this case secure the cables to a solid piece of the frame as described in the instructions included with the permanent baseplate safety cables. Be sure the safety cables do not rub against any hoses or moving parts. Do this to both sides of the vehicle.



19. Reattach the temperature sensor to the bracket mounted on the baseplate.

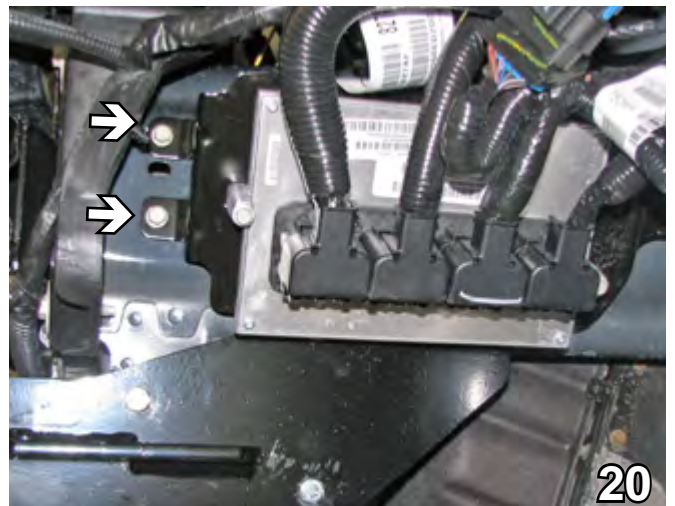

20. Reinstall the computer using the existing bolts, two (2) on the front and one on the back.



BX1994

2011-2013 Chrysler Town & Country LMT 2011-2013 Dodge Caravan (Includes Grand) Installation Instructions

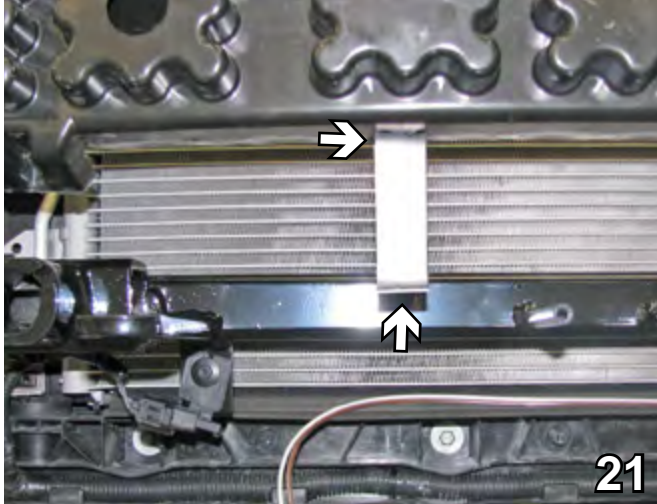

21. Install the breakaway bracket in the middle of the passenger side. Using a 13/32" drill bit, drill through the underside of the bumper. Attach the bracket to the bumper with a 1/4"-20 x 2-1/4" hex bolt and a 1/4"-20 hex nut. Attach the breakaway to the bracket with a 1/4"-20 x 3/4" hex bolt and a 1/4"-20 hex nut.

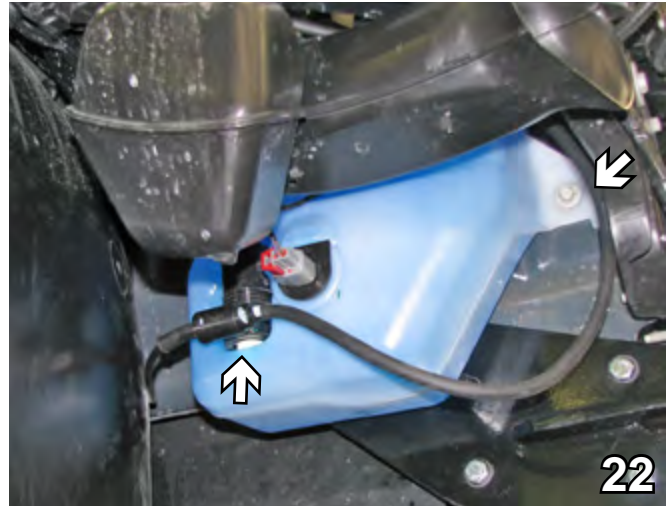

22. Reinstall the washer reservoir, using all existing bolts.

Be sure that **ALL** electrical connections are plugged in properly and functioning **BEFORE** installing the fascia.

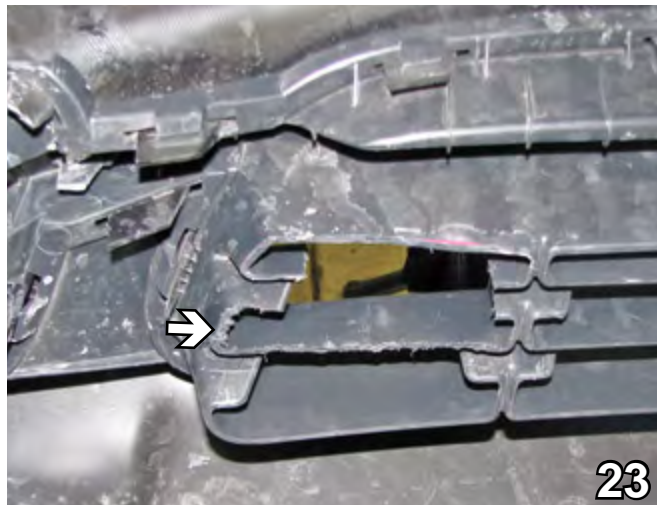

23. On the backside of the fascia in the fog light area on the outer edge of the grille middle opening, cut 1/2" in and taper to the center. Do this on both sides.

24. Replug the fog lights. Reinstall the fascia.

Install the tow bar and safety cables according to the instructions provided in their packages. When demonstrating this to the customer, be sure to include all the contents and packages.

Do NOT substitute other devices if the tow bar pins and clips are misplaced.



BX1994

2011-2013 Chrysler Town & Country LMT
2011-2013 Dodge Caravan
(Includes Grand)
Installation Instructions

DEALER or INSTALLER:
Be certain the user receives the
instruction sheets for their products.

CUSTOMER SERVICE COMMITMENT

Blue Ox is committed to providing you with exceptional customer care throughout your lifetime with our products. Our team is here to assist you with any questions you may have regarding the performance of your product. Simply call (402) 385-3051 and you can speak with our customer care team.

Additionally, please visit our website to see which rallies our Destination America team will be attending. For a nominal fee, our service technician will service your towing system to ensure it's in proper working condition. Also, as a commitment to our customers, should you visit our factory you can stay at our full service Blue Ox campground at no charge along with enjoying a factory tour.

Again, thank you for being our customer and for the confidence you have shown in the performance of our products. It is because of customers like you we enjoy the success we have today.



Shown without removable tabs installed.



Shown with removable tabs installed.

If the baseplate is in an accident, it must be replaced. DO NOT use it again! An accident can cause unseen damage and using it again could result in more damage or serious injury. DO NOT use the baseplate if it is damaged or missing parts.



© 2011 Blue Ox
One Mill Road, Industrial Park
Pender, Nebraska 68047
Phone: (402) 385-3051 • Fax: (402) 385-3360
www.blueox.com