



BLUE OX®

Baseplate Installation Instructions

BX1999

2011-12 Mitsubishi Eclipse Spyder Installation Instructions

Please read BOTH these Installation Instructions and the General Instructions before attempting to install or operate this equipment.

Serial Number

- Blue Ox® towing products and accessories are intended to be installed by Blue Ox® Dealers who are familiar with our products and have the equipment necessary and knowledge to do "fit work". When necessary Blue Ox® Dealers can be found at www.blueox.com or by contacting our Customer Care Department at (402) 385-3051.

Attachment Tab Height: 14.5"

Attachment Tab Width: 30"

- Many Blue Ox® baseplates are designed to use existing holes and hardware to mount the baseplate to the towed vehicle. Even though bolts are there, do not assume they are adequate for baseplate mounting. Always use hardware supplied in the hardware kit and existing hardware specified in the Baseplate Installation Instructions.

Bolt Torque Specifications
Torque in Foot-Pounds for Metric Bolts

Bolt Size	Grade 8.8	Grade 10.9
6MM	6	8
8MM	16	22
10MM	31	40
12MM	54	70
14MM	89	117

Confirm the towability and pre-towing procedures for your vehicle with the owner's manual or contact the vehicle's manufacturer for specific towing procedures.

Bolt Torque Specifications
Torque in Foot-Pounds for Inch Bolts

Bolt Size	Grade 5	Grade 8
1/4"	10	14
5/16"	19	29
3/8"	33	47
7/16"	54	78
1/2"	78	119
5/8"	154	230



If the front of your vehicle looks different than this, call us at (402) 385-3051.

! WARNING

Failure to read and follow these instructions could result in separation of the towed vehicle from the tow bar, causing property damage, loss of towed vehicle, personal injury or death.

BX1999

2011-12 Mitsubishi Eclipse Spyder

Installation Instructions

Tools Required		
8MM Socket	10MM Socket	14MM Socket
Drill	Torque Wrench	9/16" Socket
Utility Knife	13/32" Drill Bit	1-1/4" Hole Saw
Flat Screwdriver	Phillips Screwdriver	Diagonal Cutters
Loctite® RED		

ITEM NO.	PART NUMBER	DESCRIPTION	QTY.
1	61-6973	WLDM'T, BP, BX1999	1
2	201-0050	1/4-20 X 3/4 HEX BOLT, GRD. 5, ZP	1
3	202-0102	1/4-20 HEX NYL NUT, ZP	1
4	201-0368	3/8-16 X 1 1/4 HEX HEAD BOLT,GRD. 5	6
5	203-0010	3/8" LOCK WASHER, ZP	9
6	61-5208	WLD, NUT PLATE, 1/4 X 1 X 1(3/8-16)w/ 14" WIRE	4
7	202-0047	#10-32 HEX NUT	2
8	202-0090	3/8-16 HEX NYL. INS. LOCK NUT, ZP	2
9	203-0054	#10 LOCK WASHER	2
10	101-5822	ADAPTER, 4 WAY CONNECTOR	2
11	102-7287	BREAKAWAY BRACKET, BX1999	1
12	201-0553	1/4-20 X 1/2" HEX WASHED, TYPE F, ZP	2
13	201-0192	#10-32-1/2" SLOT, ROUND HEAD SCREW	2
14	62-3468	ATT TAB ASSY, REM, SF/SB, 1 HOLE	2
15	294-0805	CONNECTOR, 4 PIN, (NOT PROVIDED)	1
16	294-0902	CONNECTOR 6 PIN, BLK PLASTIC (NOT PROVIDED)	1
17	201-0418	8MM-1.25 X 35 MM HEX BOLT, GRD. 8.8, ZP	2
18	201-0378	8MM-1.25 X 25 MM HEX BOLT, GRD. 8.8, ZP	1

Parts Not Pictured:		
Qty.	Part #	Description
2	226-0046	Baseplate Safety Cables
2	229-0359	Quicklink, 3/8, ZP
2	290-0437	Cap Plug, Black

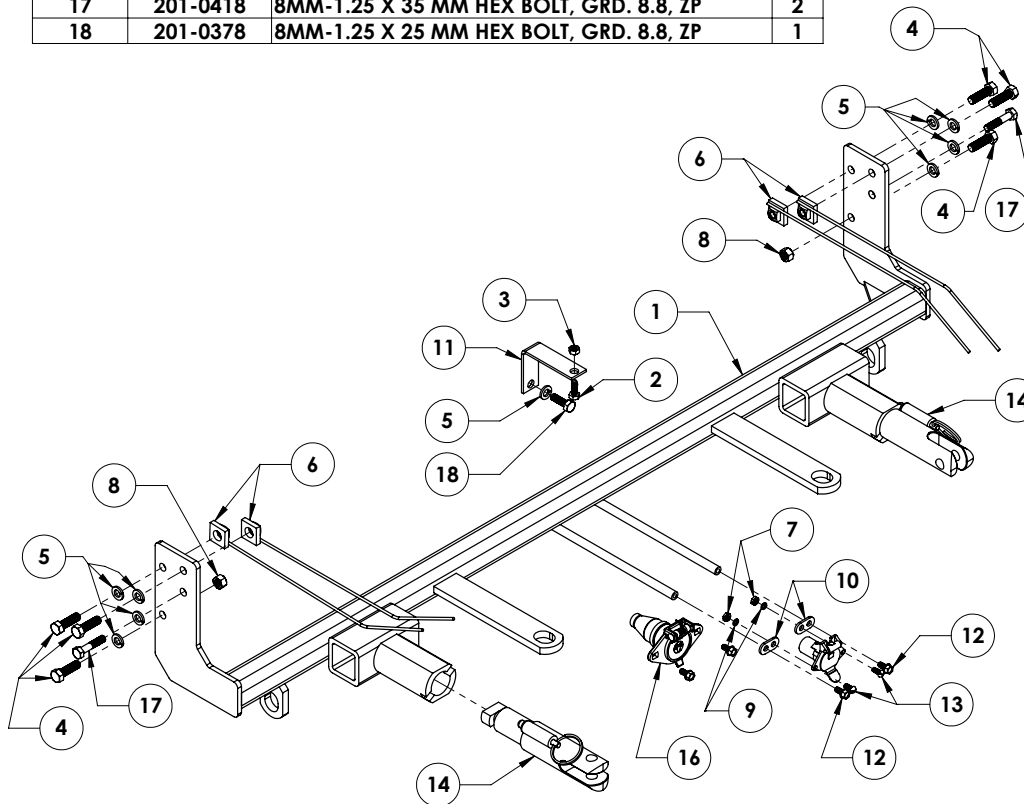

Important:

Use only genuine factory replacement parts on your baseplate. Do NOT substitute homemade or non-typical parts. If a bolt is lost or in need of replacement, for your safety and the preservation of your baseplate, be sure to use a replacement bolt of the same grade (In most cases it will be Grade 5, please reference the parts list above). Replacement parts may be ordered through your nearest Blue Ox® Dealer or Distributor, or call our Customer Care Team at (402)385-3051. Failing to follow and/or altering these installation instructions in either installation or required equipment will void the manufacturer's warranty.

BX1999

2011-12 Mitsubishi Eclipse Spyder

Installation Instructions

Removable Tabs: Motorhome mount tow bars are recommended for use with this baseplate. Due to the design of the removable tabs, the RangeFinderII and Ambassador tow bars can not be used. Adapters, except the BX8833, BX88262 and BX88151, can not be used with this baseplate.

Instruction Notes: The fascia, plastic fascia guard and bumper are removed and reinstalled for the baseplate installation. Temperature sensor is disconnected during installation and reconnected when baseplate installation is complete. Drilling is required. Trimming is required.

The dimensional variations between otherwise identical vehicles can be considerable. While the baseplate was designed for easy installation, it may be necessary to tailor the baseplate slightly to compensate for auto manufacturer's tolerances. These minor adjustments may include filing a hole slightly, bending electrical rods or bending end plates.

The BX8848 4-Diode Wiring Kit is recommended for this vehicle.

Do not use the towed vehicle for storing luggage, equipment, etc. This may cause you to exceed the towing capacity of the tow bar, baseplate, and its accessories.

Handling of some cosmetic parts when installing this product may require the use of protective covers, rags, specialty tools, etc. to prevent damage.

Installation Instructions:

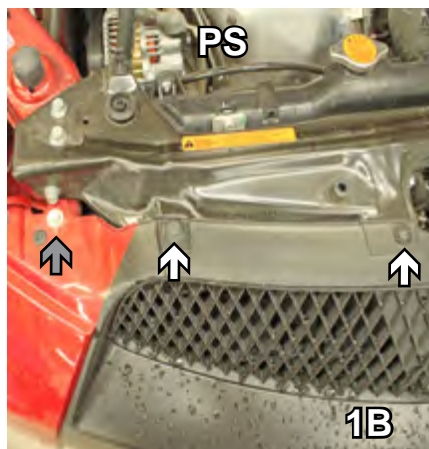
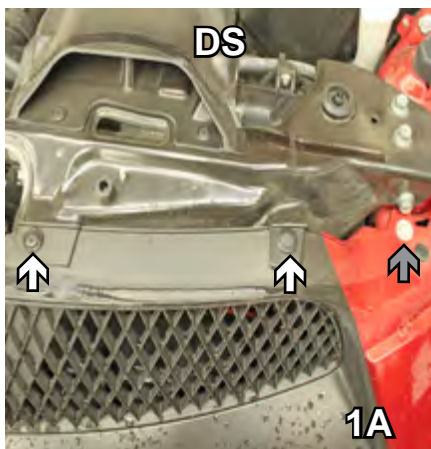

1. With flat screwdriver, remove four push pins from the top of the fascia (white arrows) and with 10MM socket, remove two 10MM bolts (gray arrows) (1A and 1B). Set push pins and bolts aside to be reinstalled later.
2. With flat screwdriver, release the pin holding on the plastic radiator cover by inserting it into the slotted area shown in the above picture. Do this to both sides of the vehicle.

BX1999

2011-12 Mitsubishi Eclipse Spyder

Installation Instructions



3. In front of tire, remove three push pins. Do this to both sides of the vehicle. Set push pins aside to be reinstalled later.
4. In front of tire, with 8MM socket, remove one bolt. Do this to both sides of the vehicle. Set bolts aside to be reinstalled later.
5. Pull wheel well cover back and with a 10MM socket, remove two bolts from inside the wheel well. Do this to both sides of the vehicle. Set bolts aside to be reinstalled later.

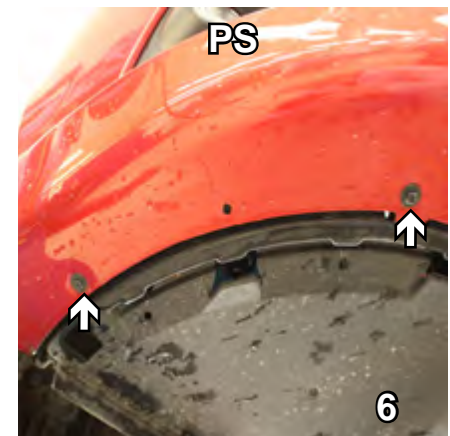
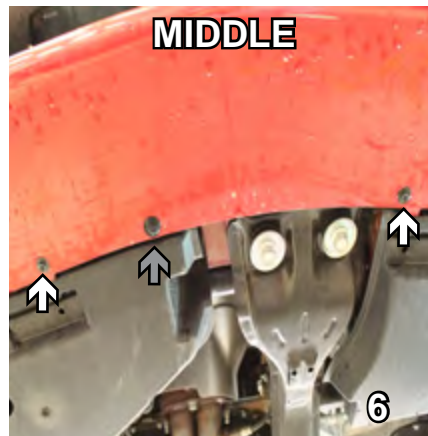
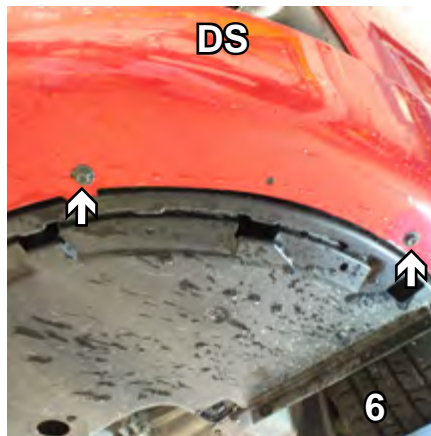

6. Underneath the fascia, with 8MM socket or Phillips screwdriver, remove six bolts (white arrows) and one push pin (gray arrow). Set bolts and push pin aside to be reinstalled later.

7. Underneath the fascia, remove two additional push pins. Set push pins aside to be reinstalled later. Carefully remove fascia and set aside. The fascia will be reinstalled after the baseplate installation is complete.



BX1999

2011-12 Mitsubishi Eclipse Spyder

Installation Instructions

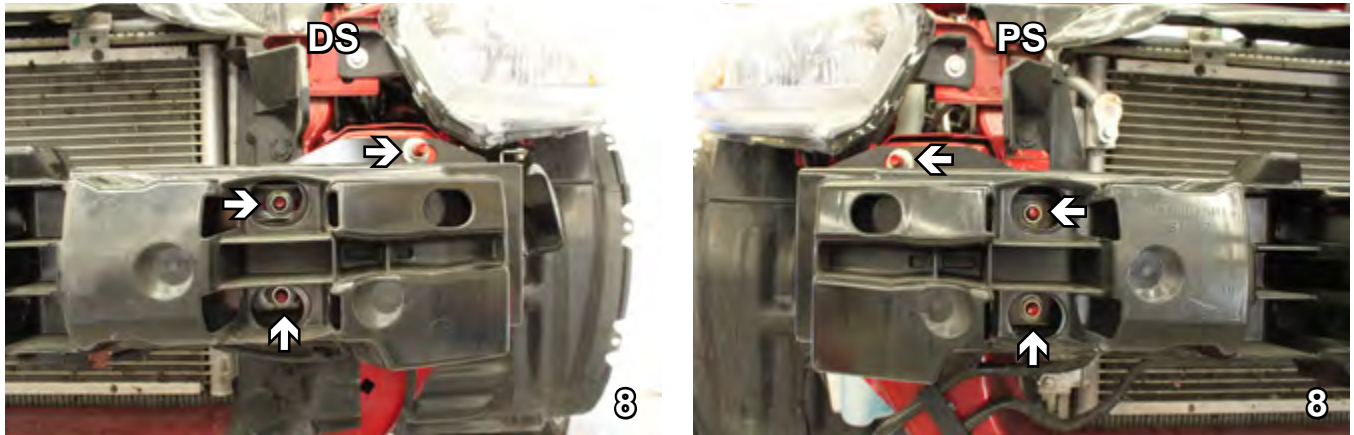

8. With a 14MM socket, remove three bolts from the bumper. Do this to both sides of the vehicle.



9. Disconnect the temperature sensor from the driver's side underneath the bumper. Move temperature sensor aside and remove bumper. Set bumper aside to be reinstalled later.

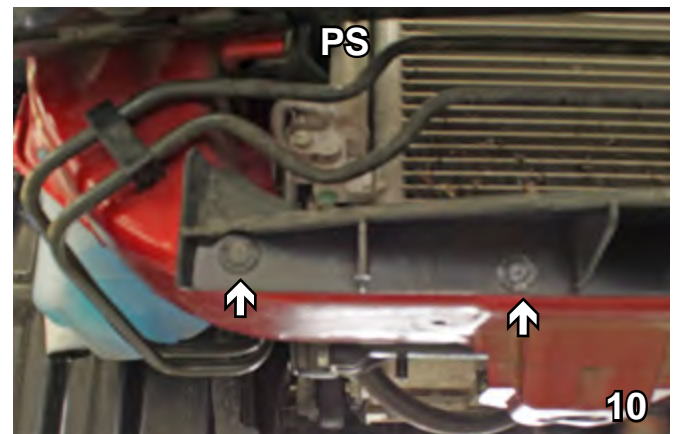
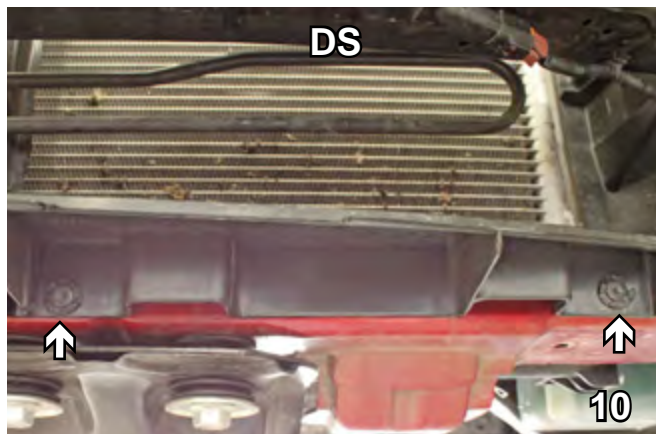

10. To remove plastic fascia guard, with a flat screwdriver, remove four push pins. Set push pins and plastic fascia guard aside to be reinstalled later.

BX1999

2011-12 Mitsubishi Eclipse Spyder

Installation Instructions

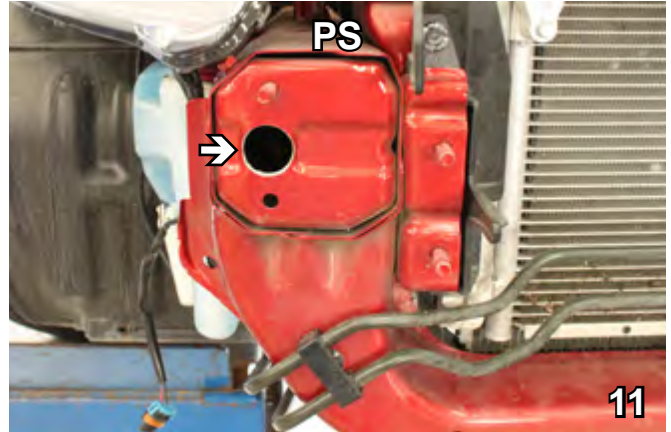
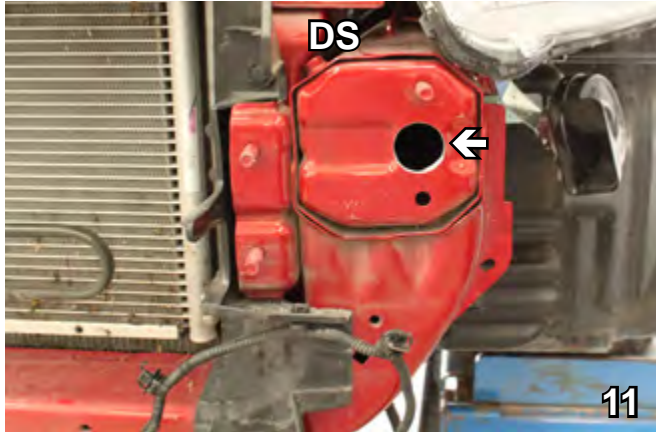

11. With 1-1/4" hole saw, drill through the bumper horn as shown above to accommodate installation of welded nut plates. Do this on both sides of the vehicle.

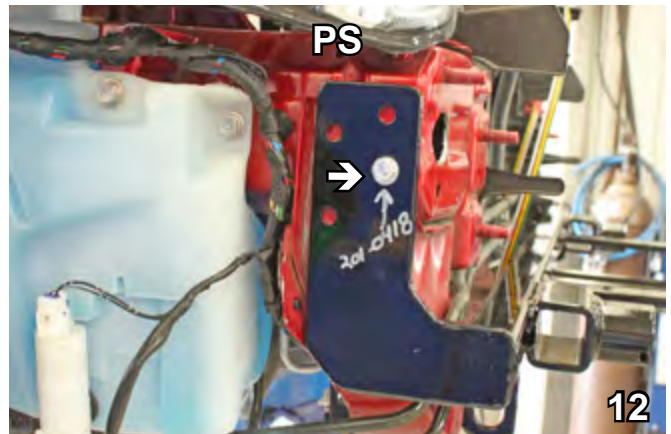
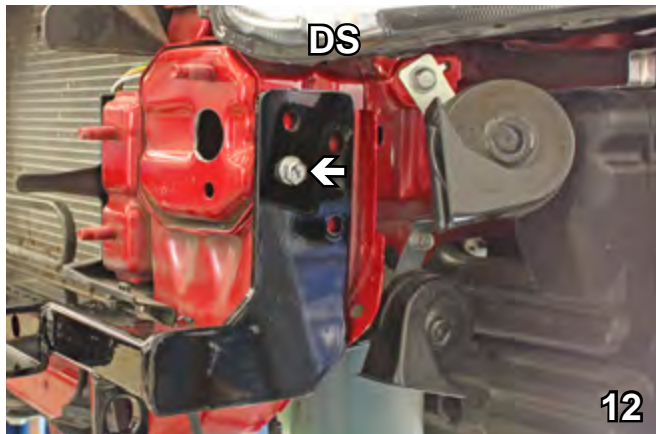

12. Slide baseplate up to the frame of the vehicle, aligning with the existing holes as shown. Ensure baseplate always remains level. In existing holes, install 8MM-1.25 x 35MM hex bolt with 3/8" lock washer. Do this on both sides of the vehicle. Use Loctite Red on all bolts.

BE SURE TO USE LOCTITE® RED ON ALL BOLTS BEFORE TIGHTENING. TIGHTEN ALL BOLTS ACCORDING TO THE TORQUE CHART ON THE FRONT PAGE OF THESE INSTRUCTIONS OR ON PAGE 3 OF THE BASEPLATE TOWING GENERAL INSTRUCTIONS.

When using power drills be aware of the dangers of torque and drill bit length.

BX1999

2011-12 Mitsubishi Eclipse Spyder Installation Instructions

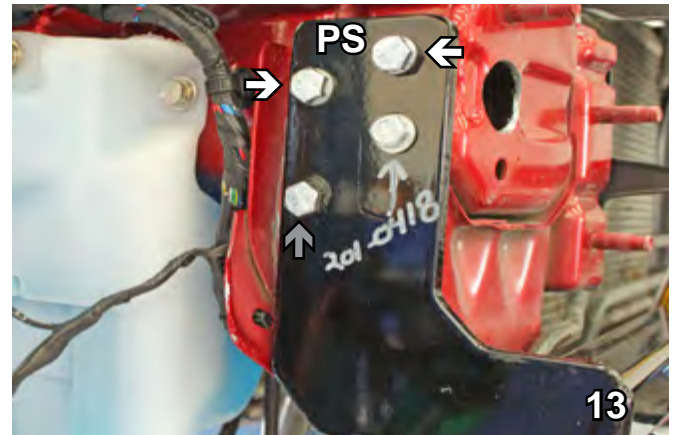
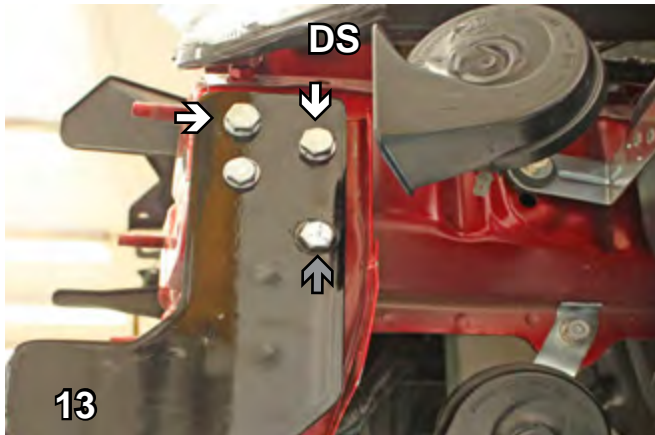

13. With 13/32" drill bit, using the baseplate as a template, drill remaining three holes on both sides of the vehicle. Install 3/8-16 x 1-1/4 hex bolts with 3/8" lock washers and welded nut plates into the top two holes of the baseplate (white arrows). Insert 3/8-16 x 1-1/4 hex bolts with 3/8-16 hex nyl. ins. lock nuts into the bottom holes (gray arrows). Do this on both sides of the vehicle. Always ensure baseplate remains level. Use Loctite Red on all bolts.

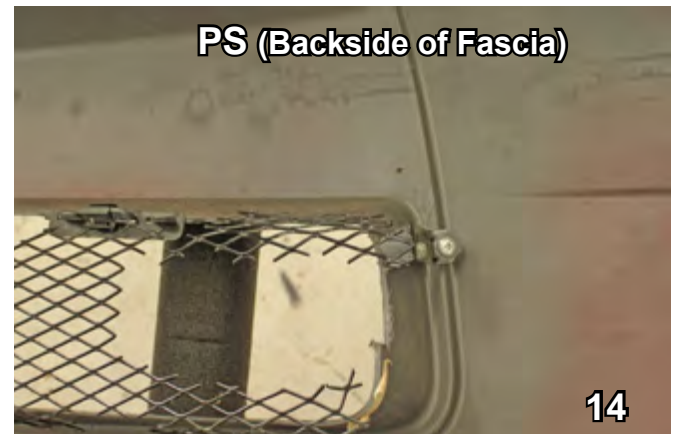
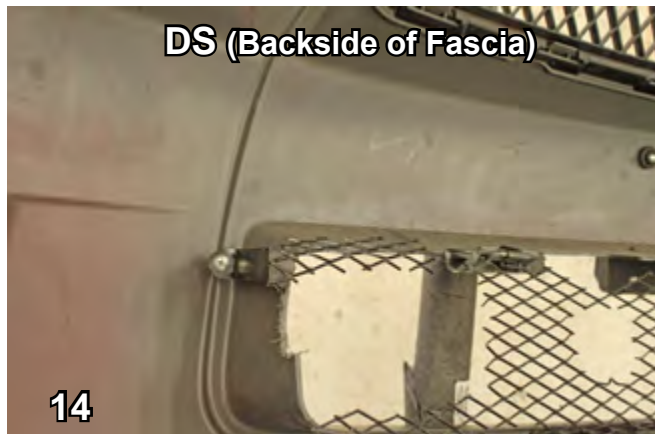

14. Hold fascia up as close as possible to its original position. Mark area on fascia where trimming will be required to have attachment tabs, quicklinks and breakaway bracket (if applicable) to come through. If fascia is metal, use diagonal cutters to trim the fascia openings you have marked. If fascia is plastic, a utility knife can be used for trimming.

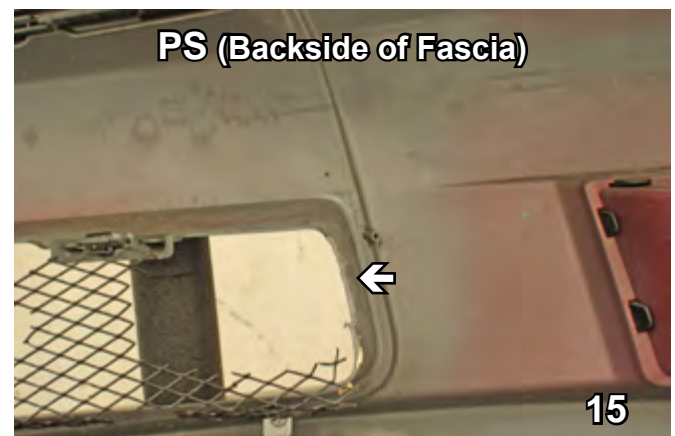
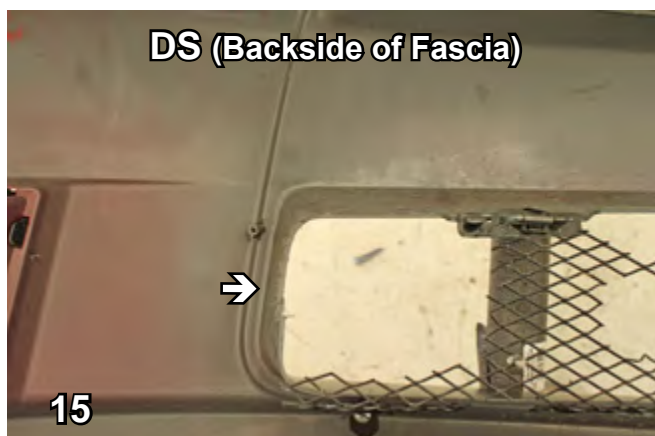

15. With Phillips screwdriver, remove two screws on the upper corners of the fascia. Trim additional area as shown in the pictures above to allow baseplate to come through the fascia. With a utility knife, trim back the outer edges of the fascia opening (white arrows). Do this on both sides of the fascia opening.

BX1999

2011-12 Mitsubishi Eclipse Spyder

Installation Instructions

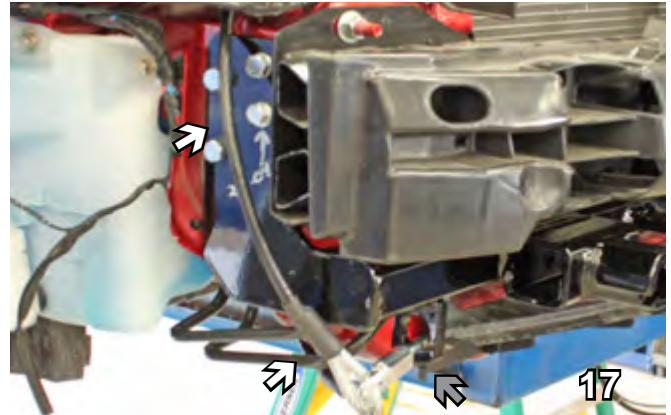
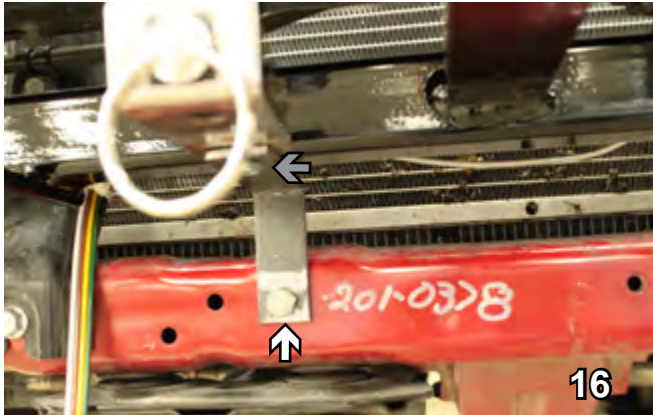

16. OPTIONAL: Install the breakaway bracket and breakaway on the driver's side of the vehicle between the quicklinks and electrical rods. Using existing hole on the frame underneath the baseplate, insert 8MM-1.25 x 25 hex bolt and 3/8" lock washer to secure the bracket (white arrow). Attach breakaway to the bracket with 1/4-20 x 3/4 hex bolt with 1/4-20 nyl nut (gray arrow). Reinstall bumper and reconnect temperature sensor.
17. Attach the permanent baseplate safety cables to the provided convenience link on the baseplate (gray arrow). The photo above shows the recommended installation of the cables to frame of vehicle (white arrows). Additional options may interfere with suggested mounting; in this case, secure the cables to a solid piece of the frame as described in the instructions included with the permanent baseplate safety cables. Be sure the safety cables do not rub against any hoses or moving parts. Do this on both sides of the vehicle.
18. Reinstall plastic fascia guard.
19. Reinstall fascia.

Install the tow bar and safety cables according to the instructions provided in their packages. When demonstrating this to the customer, be sure to include all the contents and packages.

Do not substitute other devices if the tow bar pins and clips are misplaced.

DEALER or INSTALLER:
Be certain the user receives the instruction sheets for their products.

Be sure that **ALL** electrical connections are plugged in properly and functioning **BEFORE** installing the fascia.

BX1999

2011-12 Mitsubishi Eclipse Spyder

Installation Instructions



Shown with removable tabs installed



Shown without removable tabs installed

CUSTOMER SERVICE COMMITMENT

Blue Ox is committed to providing you with exceptional customer care throughout your lifetime with our products. Our team is here to assist you with any questions you may have regarding the performance of your product. Simply call (402) 385-3051 and you can speak with our customer care team.

Additionally, please visit our website to see which rallies our Destination America team will be attending. For a nominal fee, our service technician will service your towing system to ensure it's in proper working condition. Also, as a commitment to our customers, should you visit our factory, you can stay at our full service Blue Ox campground at no charge along with enjoying a factory tour.

Again, thank you for being our customer and for the confidence you have shown in the performance of our products. It is because of customers like you we enjoy the success we have today.

If the baseplate is in an accident, it must be replaced. DO NOT use it again! An accident can cause unseen damage and using it again could result in more damage or serious injury. DO NOT use the baseplate if it is damaged or missing parts.



© 2011 Blue Ox
One Mill Road, Industrial Park
Pender, Nebraska 68047
Phone: (402) 385-3051
Fax: (402) 385-3360
www.blueox.com