



# BX2198

## 2006-10 Ford Explorer 2007-10 Ford Explorer Sport Trac Installation Instructions

**Please read BOTH these Installation Instructions and the General Instructions before attempting to install or operate this equipment.**

**Serial Number**

- Blue Ox® towing products and accessories are intended to be installed by Blue Ox® Dealers who are familiar with our products and have the necessary equipment and knowledge to do “fit work”. When necessary Blue Ox® Dealers can be found at [www.blueox.com](http://www.blueox.com) or by contacting our Customer Care Department at (402) 385-3051 or toll free at (800)228-9289.
- Many Blue Ox® baseplates are designed to use existing holes and hardware to mount the baseplate to the towed vehicle. Even though bolts are there, do not assume they are adequate for baseplate mounting. Always use hardware supplied in the hardware kit and existing hardware specified in the Baseplate Installation Instructions.

Attachment Tab Height: 24”

Attachment Tab Width: 20”

**Bolt Torque Specifications**  
Torque in Foot-Pounds for Metric Bolts

Bolt Size	Grade 8.8	Grade 10.9
6MM	6	8
8MM	16	22
10MM	31	40
12MM	54	70
14MM	89	117

Confirm the towability and pre-towing procedures for your vehicle with the owner’s manual or contact the vehicle’s manufacturer for specific towing procedures.

**Bolt Torque Specifications**  
Torque in Foot-Pounds for Inch Bolts

Bolt Size	Grade 5	Grade 8
1/4”	10	14
5/16”	19	29
3/8”	33	47
7/16”	54	78
1/2”	78	119
5/8”	154	230



### **WARNING**

Failure to read and follow these instructions could result in separation of the towed vehicle from the tow bar, causing property damage, loss of towed vehicle, personal injury or death.

**BX2198**  
**2006-10 Ford Explorer**  
**2007-10 Ford Explorer Sport Trac**  
**Installation Instructions**

## Parts List

Ref. No.	Qty.	Part #	Description
1	1	61-6464	WLDM'T, BASEPLATE, BX2198
2	8	61-4029	WELDMENT, 1/2 NUT WIRE COMMON
3	8	201-0068	1/2-13 X 1 3/4 HEX BOLT GRD.5, ZP
4	8	203-0012	1/2 LOCK WASHER, ZP
5	1	201-0654	#10-16 X 1 SELF DRILLING SCREW
6	2	201-0553	1/4-20 X 1/2 HX.WSHD.TYPE F TCS, ZP
7	2	201-0192	10-32 X 1/2 SLOT, RD. HD. SCREW
8	2	203-0054	#10 LOCK WASHER
9	2	202-0047	#10-32 HEX NUT
10	2	101-5822	ADAPTER, 4 WAY CONNECTOR
11	2	62-3468	ATT TAB ASSY, REM, SF/SB, 1 HOLE
	2	290-0437	RECEIVER, CAP PLUG (BLK) (NOT SHOWN)
	2	226-0046	BASEPLATE SAFETY CABLE, 36" CL III (NO SH)
	2	229-0359	QUICKLINK, 3/8, ZP (NOT SHOWN)

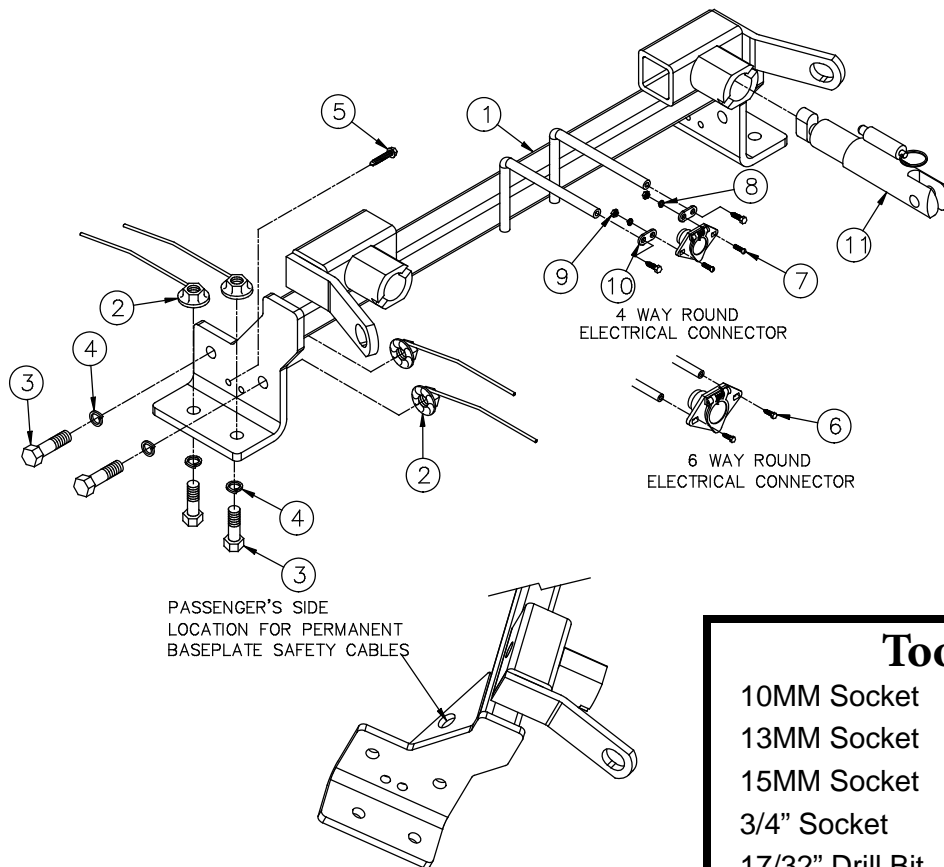

### Tools Required

10MM Socket	Vise Grips
13MM Socket	Utility Knife
15MM Socket	Reciprocating Saw
3/4" Socket	Flat Screwdriver
17/32" Drill Bit	Phillips Screwdriver
5/16" Nut Driver	Loctite Red

### Important:

Use only genuine factory replacement parts on your baseplate. Do NOT substitute homemade or non-typical parts. If a bolt is lost or in need of replacement, for your safety and the preservation of your baseplate, be sure to use a replacement bolt of the same grade. In most cases it will be Grade 5. Please reference the parts list above. Replacement parts may be ordered through your nearest Blue Ox® dealer or distributor, or call our Customer Care Team at (402)385-3051 or toll free (800) 228-9289.

BX2198  
2006-10 Ford Explorer  
2007-10 Ford Explorer Sport Trac  
Installation Instructions

## Attachment Tabs

Motorhome mount tow bars are recommended for use with this baseplate. Due to the design of the removable tabs, the RangeFinderII, Adventurer, and Ambassador tow bars can not be used. The Acclaim tow bar may be used, but will not fold and store on the front of the vehicle. Adapters, except the BX8833 and BX88151, can not be used with this baseplate.

## Instructions

The front fascia, metal bumper and air dams are removed for the baseplate installation. Drilling is required. Trimming of the air dam and metal bumper is required. Trimming of the fascia may be necessary.

The dimensional variations between otherwise identical vehicles can be considerable. Although the baseplate was designed for easy installation, it may be necessary to tailor the baseplate slightly to compensate for auto manufacturer's tolerances. These minor adjustments may include filing a hole slightly, bending electrical rods, and/ or bending end plates.

The BX8869, Bulb and Socket Wiring Kit is recommended for this vehicle.

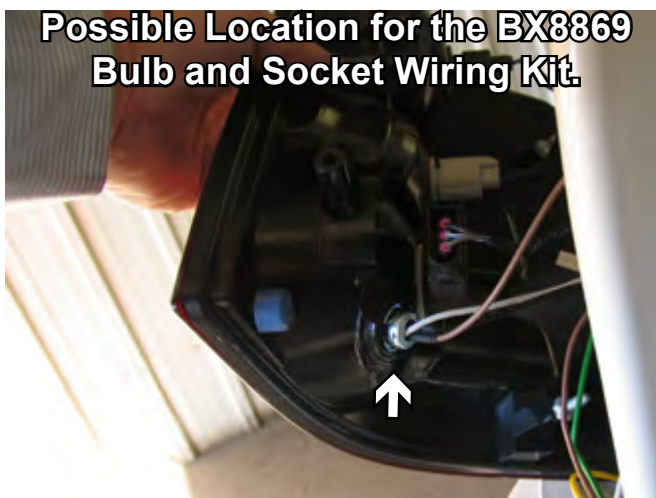

## Installation Instructions

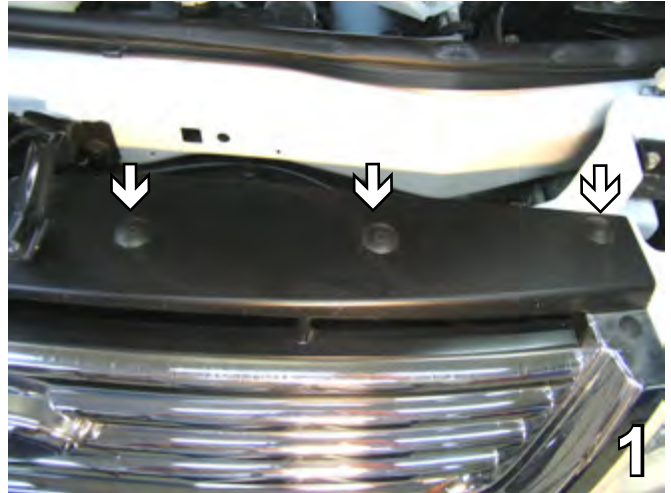

1. Using a Phillips screwdriver, remove three (3) pushpins from the black plastic cover on the top side of the fascia. Do this to both sides of the vehicle. Set pushpins aside to be reinstalled later.

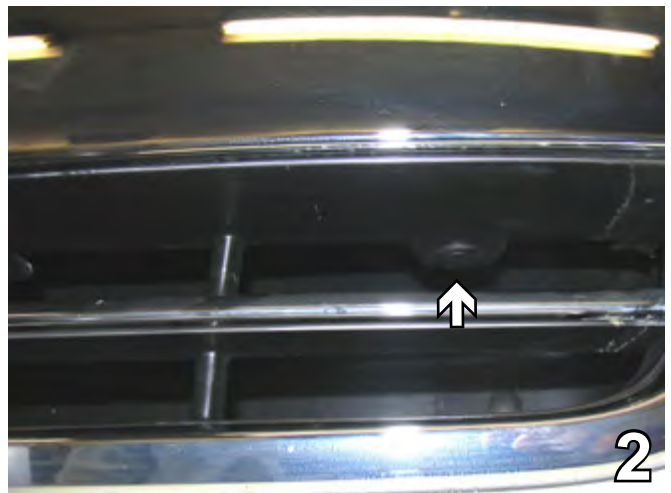

2. Remove the four (4) pushpins from upper fascia opening just behind the license plate bracket. Do this to both sides of the vehicle. Set pushpins aside to be reinstalled later.

BX2198  
2006-10 Ford Explorer  
2007-10 Ford Explorer Sport Trac  
Installation Instructions



3. Just forward of the front tire on the fascia's lower edge, remove one (1) Christmas tree pushpin. Do this to both sides of the vehicle. Set pushpins aside to reinstall later.



4. Using a 10MM socket, remove the two (2) metric bolts from lower tabs on the bottom edge of the fascia. Set the bolts aside to be reinstalled later.



5. Just forward of the front tire on the fascia's corner, remove the two (2) screws with a Phillips screwdriver. Do this on both sides of the vehicle. Pull fascia corners down, then forward to release. Disconnect electrical connections. Set the fascia and screws aside to be reinstalled later.

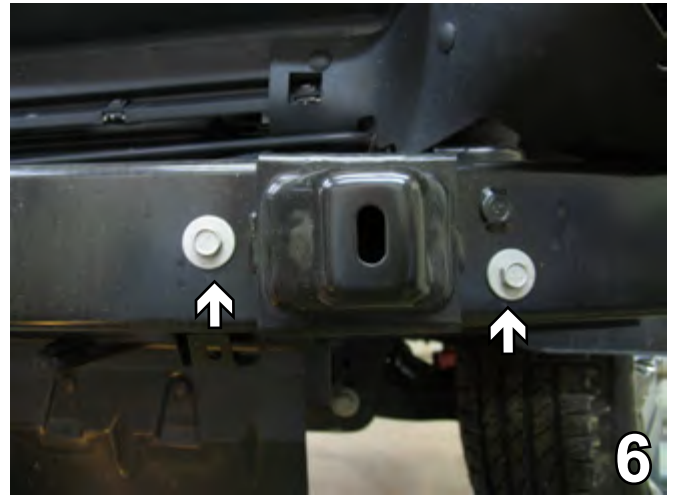

6. Using the 15MM socket, remove the two (2) metric bolts from the front of the metal bumper. Do this to both sides of the vehicle. Push down hard and out then pull the bumper forward. Set the bumper and metric bolts aside to be reinstalled later.

BX2198  
2006-10 Ford Explorer  
2007-10 Ford Explorer Sport Trac  
Installation Instructions



7. Remove the Christmas tree pushpin from the frame rail. Remove the air dam. Air dam will **NOT** be reinstalled. Do this to both sides of the vehicle.

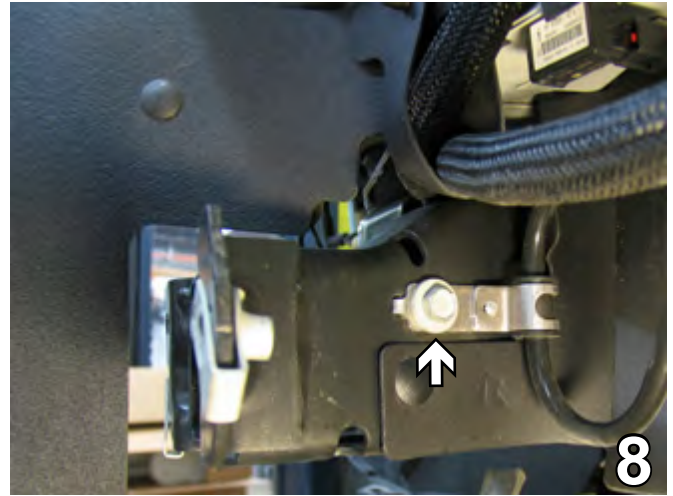

8. Using the 13MM socket, remove the metric bolt from the lower coolant line on the passenger's side, as indicated by the white arrow in the photo above. Some models may have a Block Heater cord bracket in this area to remove, as indicated by the grey arrow in the photo above.



9. Slide baseplate between frame rails. Then slide baseplate forward just behind weld of the bumper bracket. Using vise grips, clamp in place to the bottom of the frame rail. Do this to both sides of the vehicle. Using the baseplate as a template, drill the two (2) bottom holes into the frame rail with the 17/32" drill bit. Do this on both sides of the vehicle.



10. Insert the 1/2"-13 whiz nuts through the frame rail opening and align with the drilled holes. Insert the 1/2"-13 x 1-3/4" hex bolts and 1/2" lock washers and tighten. Do this to both sides of the vehicle.

BX2198  
2006-10 Ford Explorer  
2007-10 Ford Explorer Sport Trac  
Installation Instructions

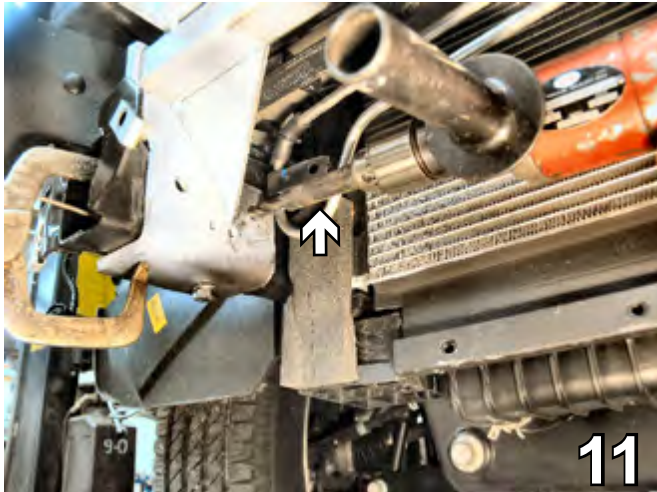

11. Using the baseplate as a template, drill the two (2) holes in the side of the frame rail with the 17/32" drill bit. Do this to both sides of the vehicle. Protect coolant pipe line when drilling (note the section of pipe on the drill bit).



12. Insert the 1/2"-13 whiz nuts to align with the drilled holes inside the frame rail and tighten the 1/2"-13 x 1-3/4" hex bolts and 1/2" lock washers. Do this to both sides of the vehicle. Cut nut plate wires to make them flush with the end of the frame rail. This prepares the area for the metal bumper reinstallation.

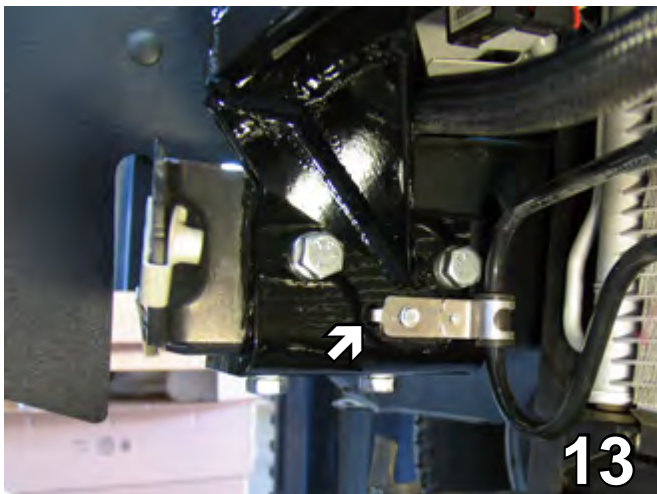

13. Insert the bent end of coolant bracket into the smaller front hole provided in baseplate on the passenger's side. Drill the self drilling screw in bracket hole provided in baseplate and into frame.

**BE SURE TO USE LOCTITE® RED ON ALL BOLTS BEFORE TIGHTENING. TIGHTEN ALL BOLTS ACCORDING TO THE TORQUE CHART.**

BX2198  
2006-10 Ford Explorer  
2007-10 Ford Explorer Sport Trac  
Installation Instructions



14. Align the metal bumper as close to its original position as possible, mark area to be cut on the top and bottom of the side bumper. The top portion is to be removed, mark 5/8" wide and approximately 2-1/2" toward the weld on the front edge of the bumper on both sides, to alleviate the area for the upper baseplate end plate. Mark the lower portion to be removed 1" wide and approximately 1-1/4" toward the front of bumper on both sides (to alleviate the area for front lower baseplate bolt head).

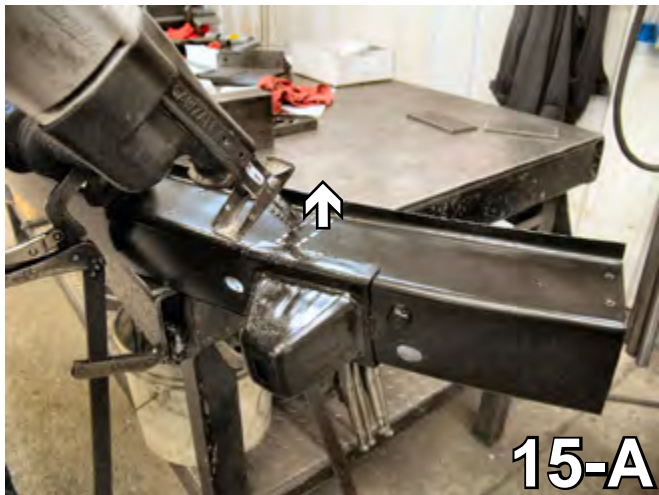

15. Secure the metal bumper to a work bench with the vise grips and cut designated areas from the previous step with the reciprocating saw. After cutting, clamp vise grip to the cut portion to be removed and move vise grip back and forth until cut portion breaks. Reinstall metal bumper to verify enough of metal bumper is removed. Trim as needed and reinstall bumper with existing hardware.

BX2198  
2006-10 Ford Explorer  
2007-10 Ford Explorer Sport Trac  
Installation Instructions

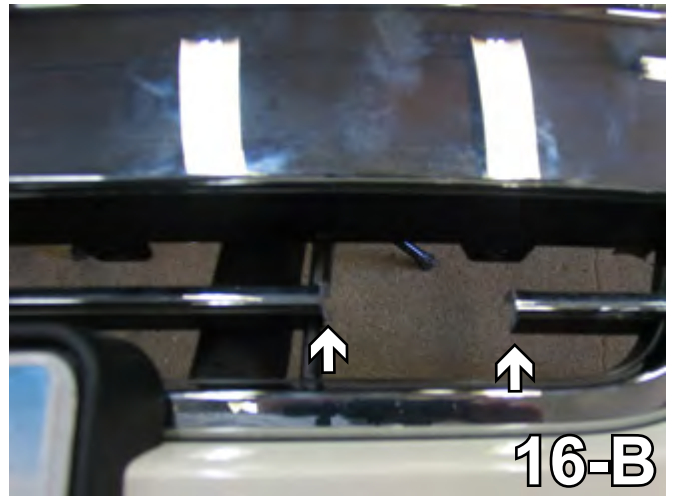
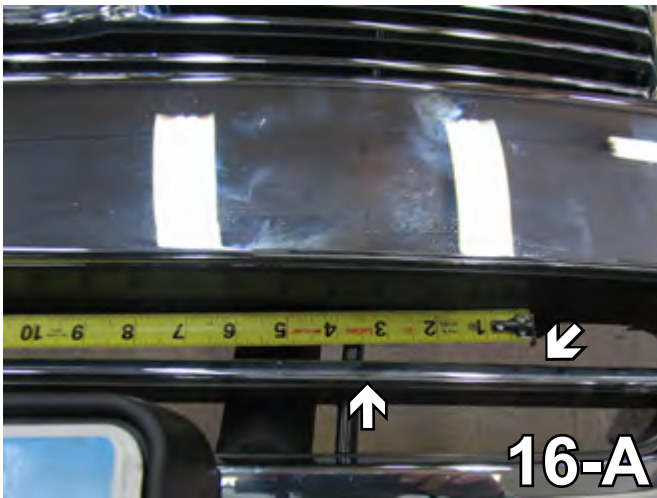

16. Using a utility knife, cut the fascia horizontal bar starting at the outer vertical bar and 3-1/2" out toward the edge. Do this on both sides of the fascia.



17. Mark the top side of the lower air dam, 1" from the outside edge of the hard plastic in toward the center of the air dam and 3" from the front edge of the air dam hard plastic to the back of the air dam. Do this to both sides of the vehicle. Then reinstall the air dam to its original position.
18. Reinstall the bumper and fascia, inserting all screws, pushpins, and bolts. Trim the bumper if necessary for the attachment tabs to come through. The installation of the baseplate is now complete.

Install the tow bar and safety cables according the instructions when demonstrating this to the customer. Be sure the safety cables do not rub against any hoses or moving parts.

Do NOT substitute other devices if the tow bar pin and clip are lost or misplaced.



BX2198  
2006-10 Ford Explorer  
2007-10 Ford Explorer Sport Trac  
Installation Instructions



**DEALER or INSTALLER:**

**Be certain the user receives the instruction sheets for their products.**

**CUSTOMER SERVICE COMMITMENT**

Blue Ox is committed to providing you with exceptional customer care throughout your lifetime with our products. Our team is here to assist you with any questions you may have regarding the performance of your product. Simply call 1-800-228-9289 and you can speak with our customer care team.

Additionally, please visit our website to see which rallies our Destination America team will be attending. For a nominal fee, our service technician will service your towing system to ensure it's in proper working condition. Also as a commitment to our customers, should you visit our factory you can stay at our full service Blue Ox campground at no charge along with enjoying a factory tour.

Again thank you for being our customer and for the confidence you have shown in the performance of our products. It is because of customers like you we enjoy the success we have today.



© 2007, 08, 09 Blue Ox  
One Mill Road, Industrial Park  
Pender, Nebraska 68047  
Phone: (402) 385-3051  
Fax: (402) 385-3360  
[www.blueox.com](http://www.blueox.com)  
10/19/09