



Please read BOTH these Installation Instructions and the General Instructions before attempting to install or operate this equipment.

Serial Number

- Blue Ox® towing products and accessories are intended to be installed by Blue Ox® Dealers who are familiar with our products and have the equipment necessary and knowledge to do "fit work". When necessary Blue Ox® Dealers can be found at www.blueox.com or by contacting our Customer Care Department at (402) 385-3051.
- Many Blue Ox® baseplates are designed to use existing holes and hardware to mount the baseplate to the towed vehicle. Even though bolts are there, do not assume they are adequate for baseplate mounting. Always use hardware supplied in the hardware kit and existing hardware specified in the Baseplate Installation Instructions.

Attachment Tab Height: 14 1/2"

Attachment Tab Width: 18"

Bolt Torque Specifications
Torque in Foot-Pounds for Metric Bolts

Bolt Size	Grade 8.8	Grade 10.9
6MM	6	8
8MM	16	22
10MM	31	40
12MM	54	70
14MM	89	117

Confirm the towability and pre-towing procedures for your vehicle with the owner's manual or contact the vehicle's manufacturer for specific towing procedures.

Do not use the towed vehicle for storing luggage, equipment, etc. This may cause you to exceed the towing capacity of the tow bar, baseplate, and its accessories.

Bolt Torque Specifications
Torque in Foot-Pounds for Inch Bolts

Bolt Size	Grade 5	Grade 8
1/4"	10	14
5/16"	19	29
3/8"	33	47
7/16"	54	78
1/2"	78	119
5/8"	154	230



If the front of your vehicle looks different than this, call us at (402) 385-3051.

⚠ WARNING

Failure to read and follow these instructions could result in separation of the towed vehicle from the tow bar, causing property damage, loss of towed vehicle, personal injury or death.

BX2255

2011-13 Honda Odyssey

Installation Instructions

Parts List

Ref. No.	Qty.	Part #	Description
1	1	61-6821	Weldment, Baseplate, BX2255
2	8	61-5208	3/8" Nutplate, with 14" Wire
3	2	201-0443	3/8-16 x 1" Hex Bolt, Grd. 5, ZP
4	8	201-0440	3/8-16 x 1 1/2" Hex Bolt, Grd. 5, ZP
5	10	203-0010	3/8" Lock Washer, ZP
6	2	202-0003	3/8-16 Hex Nut, ZP
7	4	201-0446	8MM-1.25 x 30MM Hex Bolt, Grd. 8.8, ZP
8	4	203-0102	8MM Lock Washer, ZP
9	4	203-0003	3/8" Flat Washer, ZP
10	2	201-0553	1/4-20 x 1/2" Hx. Wshd, Type F Screw
11	2	201-0192	#10-32 x 1/2" Slot, Rd. Hd. Screw
12	2	203-0054	#10 Lock Washer
13	2	202-0047	#10-32 Hex Nut, ZP
14	2	101-5822	Adapter, 4 Way Connector
15	2	62-3468	Att Tab Assy, Rem, SF/SB, 1 Hole
16	1	102-7134	Breakaway Bracket, BX2255
17	2	201-0050	1/4-20 X 3/4 Hex Bolt Grd. 5, ZP
18	2	202-0102	1/4-20 Hex Nyl Nut, ZP
19	1	201-0654	#10-16 X 1 Self Drilling Screw
	2	226-0049	Baseplate Safety Cable, 36" CL IV (Not Shown)
	2	229-0512	Quicklink, 1/2, ZP
	2	290-0437	Cap Plug, Black (Not Shown)

Tools Required

10MM Socket	Flat Screw Driver
12MM Socket	Phillips Screw Driver
9/16" Socket/Wrench	Torque Wrench
Large Vise Grips	Tape Measure
Reciprocating Saw	13/32" Drill Bit
Drill	LOCTITE Red

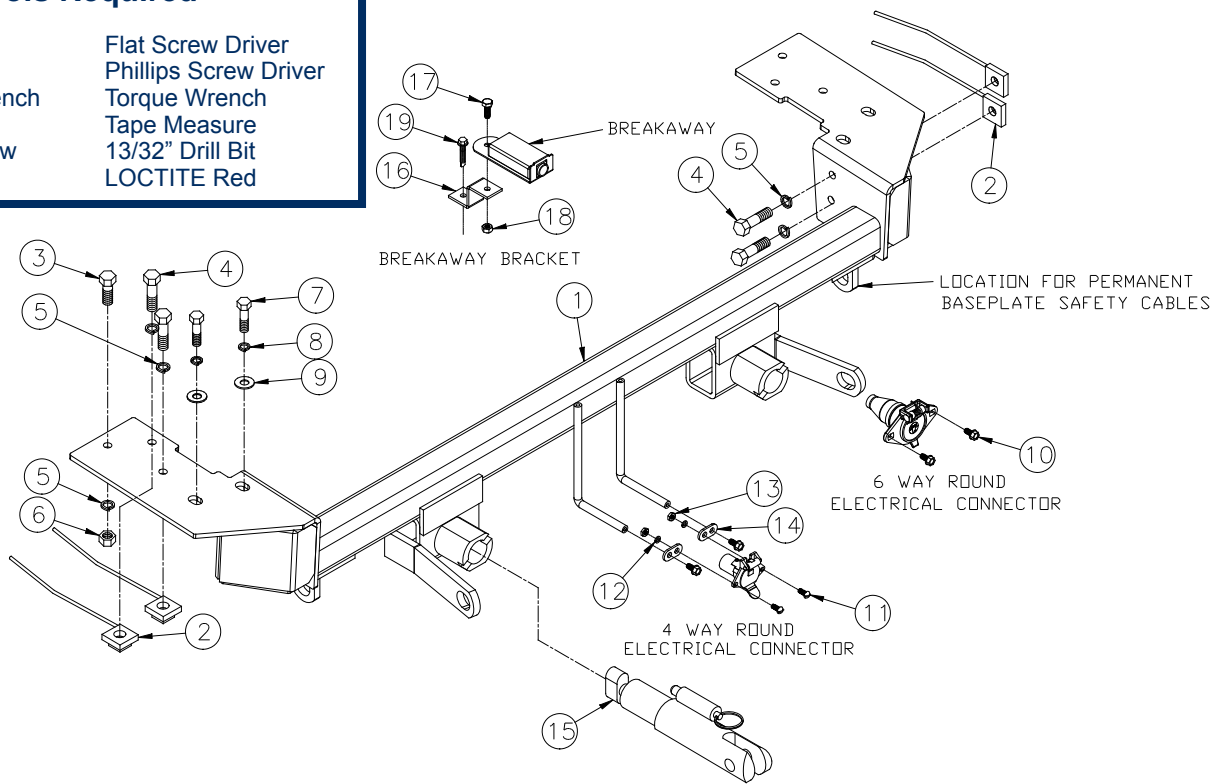

Important:

Use only genuine factory replacement parts on your baseplate. Do NOT substitute homemade or non-typical parts. If a bolt is lost or in need of replacement, for your safety and the preservation of your baseplate, be sure to use a replacement bolt of the same grade (In most cases it will be Grade 5, please reference the parts list above). Replacement parts may be ordered through your nearest Blue Ox® Dealer or Distributor, or call our Customer Care Team at (402)385-3051. Failing to follow and/or altering these installation instructions in either installation or required equipment will void the manufacturer's warranty.

BX2255

2011-13 Honda Odyssey

Installation Instructions

Removable Tabs: Motorhome mount tow bars are recommended for use with this baseplate. Due to the design of the removable tabs, the RangeFinderII and Ambassador tow bars can not be used. Adapters, except the BX8833 and BX88151, can not be used with this baseplate.

Instructions Notes: The plastic cover, front fascia, headlight assembly, and the metal bumper are removed and reinstalled for the baseplate installation. Trimming and drilling are required. The metal bumper will not be reinstalled.

The dimensional variations between otherwise identical vehicles can be considerable. While the baseplate was designed for easy installation, it may be necessary to tailor the baseplate slightly to compensate for auto manufacturer's tolerances. These minor adjustments may include filing a hole slightly, bending electrical rods or bending end plates. The BX8869 Bulb and Socket Wiring Kit is available for this vehicle.

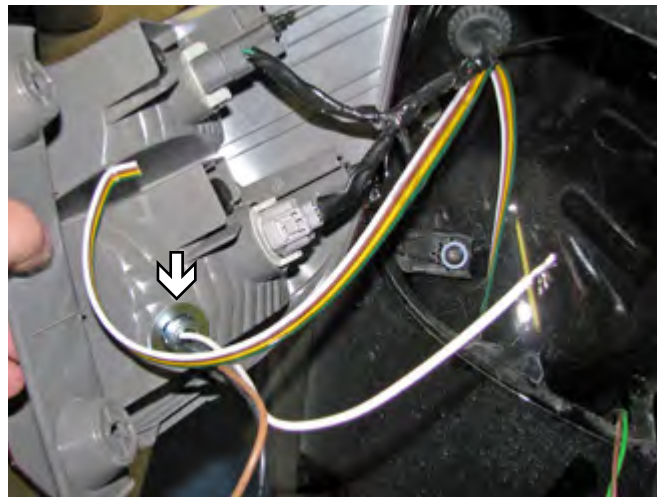

Possible location for the Bulb and Socket Wiring Kit (BX8869).

Handling of some cosmetic parts when installing this product may require the use of protective covers, rags, specialty tools, etc. to prevent damage.

Do not use the towed vehicle for storing luggage, equipment, etc. This may cause you to exceed the towing capacity of the tow bar, baseplate, and its accessories.

Installation Instructions:

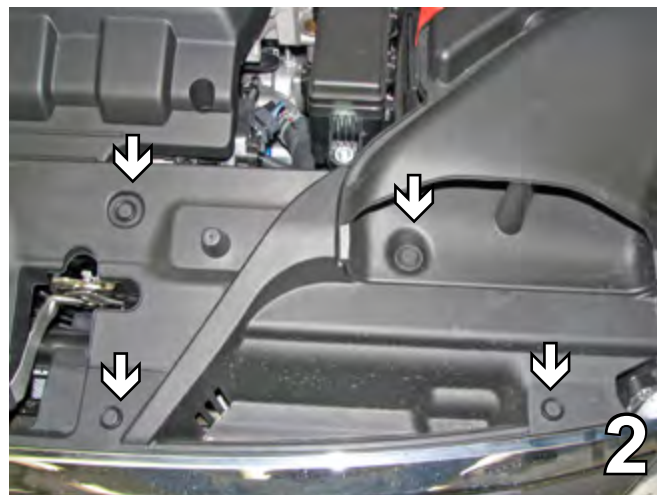

1. On the driver's side, remove the push pin from the corner of the black plastic cover on the top side of the fascia.
2. Remove the four push pins from the black plastic cover on the top side of the fascia. Do this on both sides. Lift cover up to remove. Set cover and pushpins aside to be reinstalled later.

BX2255

2011-13 Honda Odyssey

Installation Instructions



3. Using the 10MM socket, remove the bolt from the corner of the fascia. Do this to both sides of the vehicle. Set the bolts aside to be reinstalled later.
4. Using the Phillips screwdriver, remove the two Phillips screws from the corner of the fascia just forward of the front tire, inside the wheel well cover. Do this to both sides of the vehicle. Set the screws aside to be reinstalled later.



5. Underneath the fascia remove one bolt (white arrow) from the corner from just forward of the front tire. Then remove a push pin (gray arrow) followed by another bolt. Do this to both sides of the vehicle. Set bolts and push pins aside to be reinstalled later.
6. Remove a bolt (white arrow) and a push pin (gray arrow) from the lower edge of the fascia and the belly pan. Do this on both sides of the vehicle. Set the bolts and pushpins aside to be reinstalled later.



7. Remove two bolts from the center of the lower edge of the fascia. Pull the fascia forward to remove. Set the bolts and fascia aside carefully to be reinstalled later.

BX2255

2011-13 Honda Odyssey

Installation Instructions



8. Using the 12MM socket, remove two bolts from the top of the metal bumper. Do this to both sides of the vehicle.
9. Remove the bolt from the bottom of the metal bumper with the 12MM socket. Do this to both sides of the vehicle. Pull the metal bumper forward to remove. The metal bumper will not be reinstalled.



10. Make a notch in the corner where the two top bolts were to allow the baseplate to slide back further. Do this to both sides of the vehicle.
11. Remove the pushpin (gray arrow) from the top side of the headlight assembly. Also using the 10MM socket, remove one bolt (white arrow). Do this to both sides of the vehicle. Set the bolts and push pins aside to be reinstalled later.

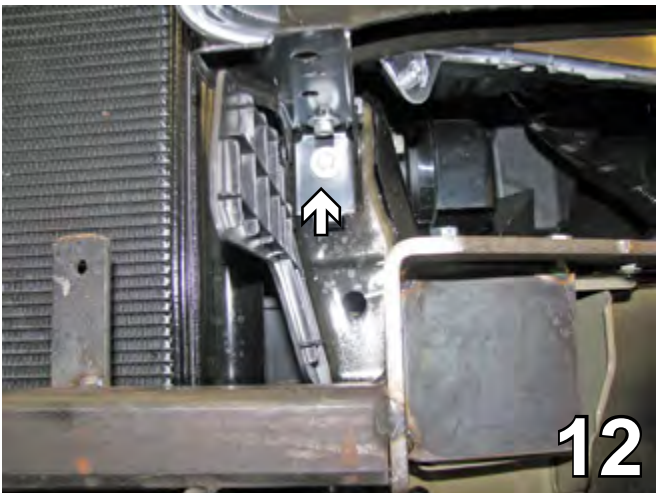

12. Using a 10MM socket, remove one bolt from the front of the headlight assembly. Do this to both sides of the vehicle. Set the bolts aside to be reinstalled later.

BX2255

2011-13 Honda Odyssey

Installation Instructions

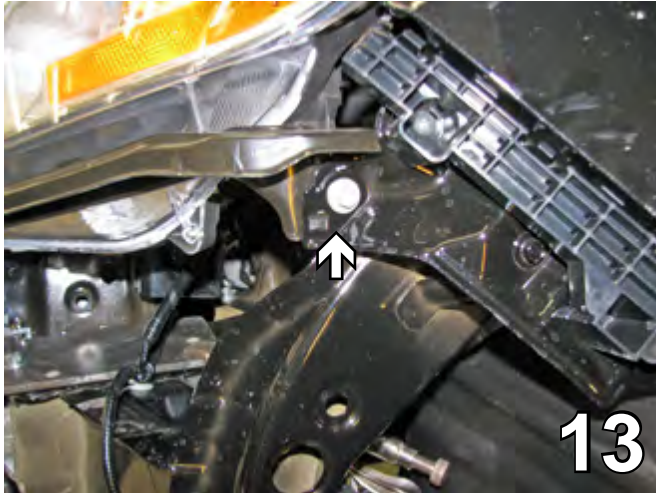

13. Using the 10MM socket, remove one bolt from the side of the headlight assembly. Do this to both sides of the vehicle. Unplug and set the headlight assembly and metric bolts aside to be reinstalled later.

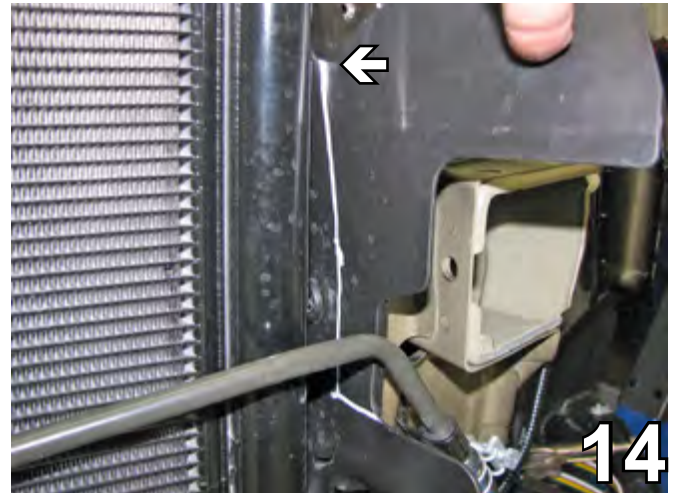

14. On the driver side, trim the shield by starting where the loop is and cutting straight down.

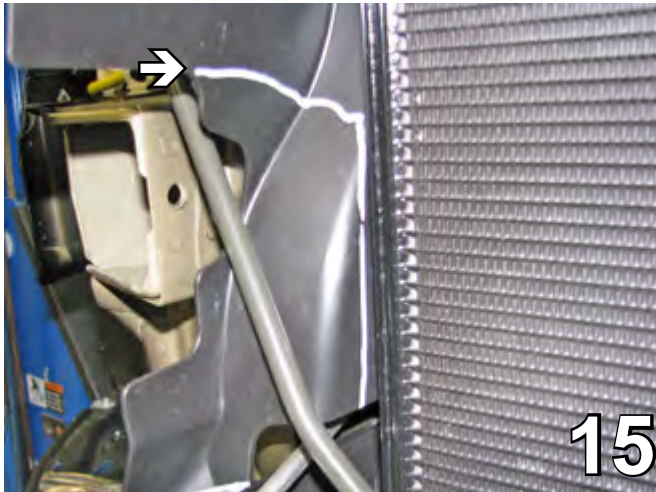

15. On the passenger side, trim across the top, down along the radiator until the opening then straight across the bottom.



16. Using a hammer, flatten the lump on both sides of the frame so that the baseplate will set flat.

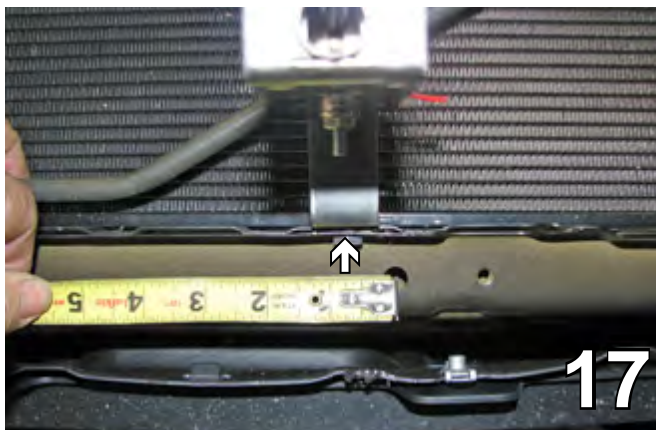

17. Measure over 3/4" from where the line hole is located and drill 1/4" hole.

BX2255

2011-13 Honda Odyssey

Installation Instructions

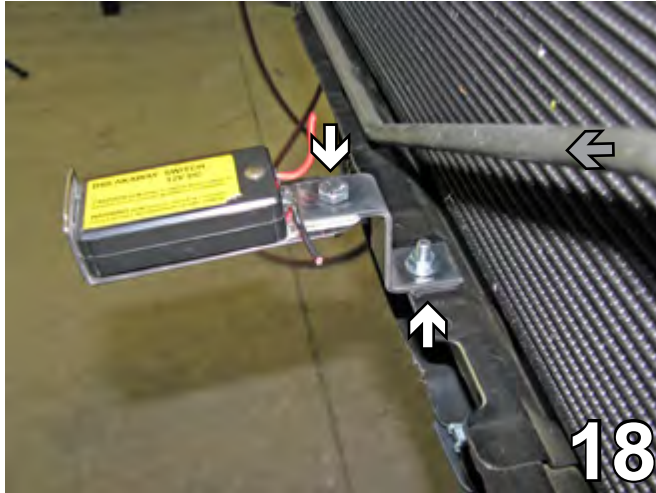

18. Attach the bracket to the vehicle and the breakaway to the bracket with 1/4-20 x 3/4" hex bolts and 1/4-20 hex nuts.

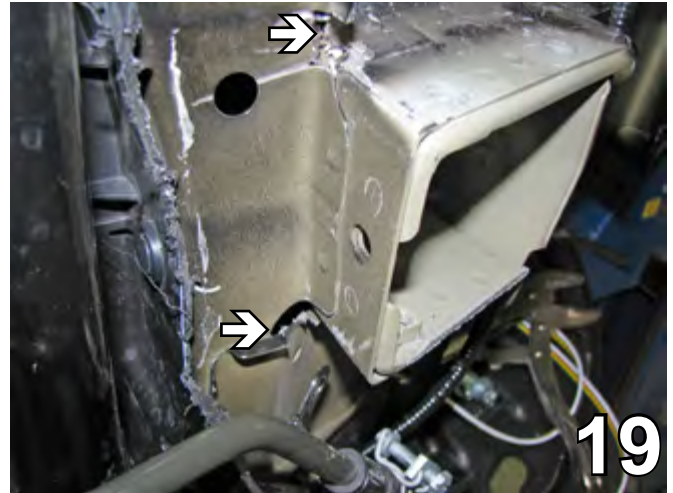

19. Cut on the top edge of the frame front webbing and 1/2" above the frame with the reciprocating saw. Be careful not to cut into coolant lines, radiator or electrical wiring. Bend the webbing toward the headlight area. Do this to both sides of the vehicle. This will open the area for the baseplate installation.



20. On the driver side, using a 10MM socket, remove one bolt from the coolant line. The line will be reinstalled lower later with a self drilling screw.

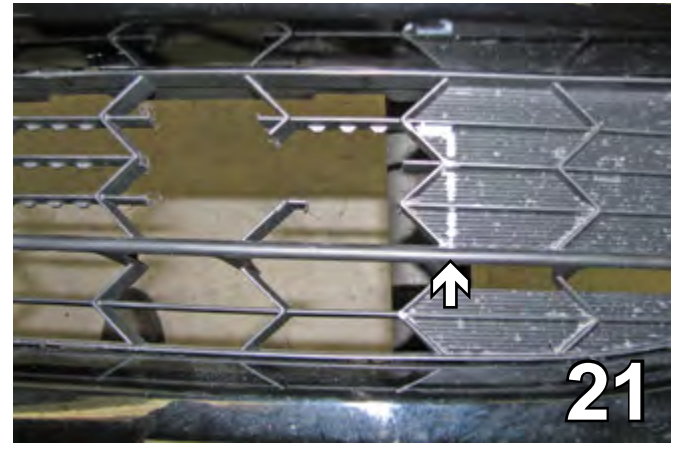

21. On the back side of the fascia, cut straight up behind the V. Do this on both sides to allow the convenient links to come through.

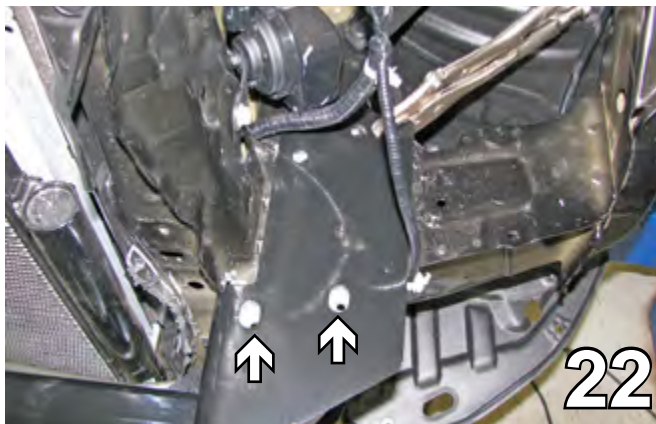

22. Slide the baseplate on the top of the frame and align the two front holes of the baseplate with the existing holes in the frame for the bumper and clamp.

BX2255

2011-13 Honda Odyssey

Installation Instructions

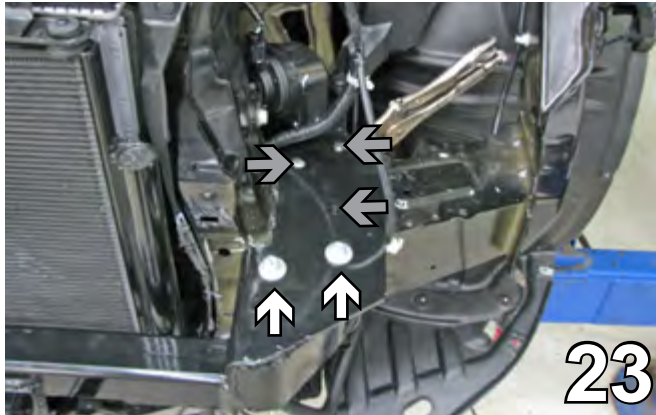

23. Tighten the 8MM-1.25 x 30MM hex bolts, 8MM lock washers, and 3/8" flat washers into the existing holes (white arrows) for the metal bumper, using the 12MM socket. Use Loctite Red on all bolts. Using the baseplate as a template, drill three holes (gray arrows) in the top of the baseplate into the frame with the 13/32" drill bit.

24. Using the baseplate as a template, drill the two holes in the side of the baseplate into the frame with an extra long 13/32" drill bit in order to get behind the extensions. Place a tube over the drill bit to prevent drilling into the radiator. Do this to both sides of the vehicle. Insert the 3/8-16 nut plate into the end of the frame to align with the drilled holes, tighten the 3/8-16 x 1 1/2" hex bolts and 3/8" lock washers with the 9/16" socket. Do this to both sides of the vehicle. Use Loctite Red on bolts.

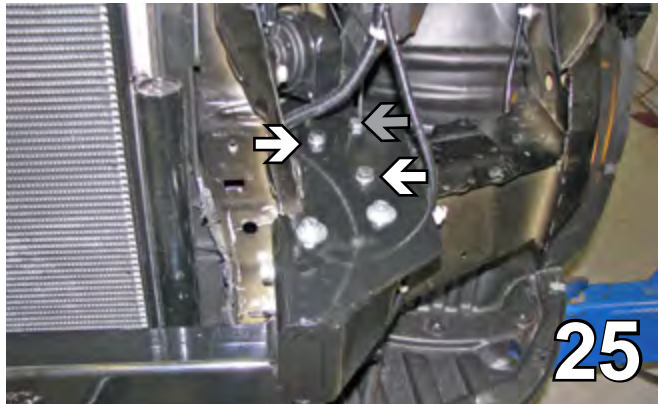

25. Insert 3/8-16 x 1 1/2" bolts and 3/8" lock washers with 3/8-16 nut plates into the middle two drilled holes (white arrows) in the top of the frame webbing. Insert the 3/8-16 x 1" hex bolt (gray arrow) into the back hole tighten the 3/8" lock washer and the 3/8-16 hex nut on the back side of the frame webbing. Do this to both sides of the vehicle. Use Loctite Red on bolts.

26. On the driver side, lower the coolant line, make sure it is not rubbing against anything and attach to the extension using 10-16 x 1" self drilling screw.

When using power drills be aware of the dangers of torque and drill bit length.

BE SURE TO USE LOCTITE® RED ON ALL BOLTS BEFORE TIGHTENING. TIGHTEN ALL BOLTS ACCORDING TO THE TORQUE CHART ON THE FRONT PAGE OF THESE INSTRUCTIONS OR ON PAGE 3 OF THE BASEPLATE TOWING GENERAL INSTRUCTIONS.

BX2255

2011-13 Honda Odyssey

Installation Instructions

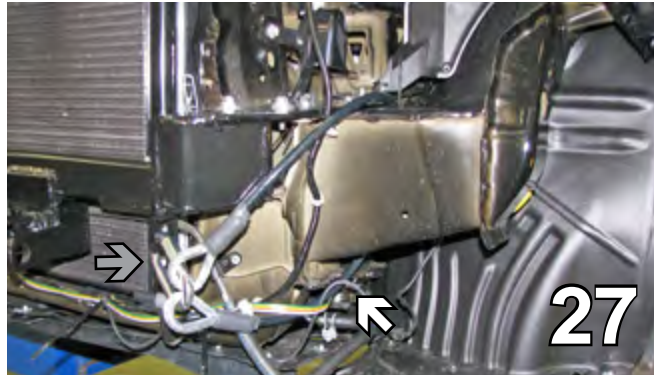

27. Attach the permanent baseplate safety cables to the provided convenience link on the baseplate (see grey arrow). The photo above shows the recommended installation of the cables to frame of vehicle (see white arrow). Additional options may interfere with suggested mounting; in this case secure the cables to a solid piece of the frame as described in the instructions included with the permanent baseplate safety cables. Be sure the safety cables do not rub against any hoses or moving parts. Do this to both sides of the vehicle.
28. Reinstall the headlight assembly, fascia, plastic cover, bolts and push pins.

Install the tow bar and safety cables according to the instructions included in their packages.

Do not substitute other devices if the tow bar pin and clip are lost.

DEALER or INSTALLER:
Be certain the user receives the
instruction sheets for their products.

Be sure that **ALL** electrical connections
are plugged in properly and functioning
BEFORE installing the fascia.

BX2255

2011-13 Honda Odyssey

Installation Instructions



Shown without removable tabs installed



Shown with removable tabs installed

CUSTOMER SERVICE COMMITMENT

Blue Ox is committed to providing you with exceptional customer care throughout your lifetime with our products. Our team is here to assist you with any questions you may have regarding the performance of your product. Simply call (402) 385-3051 and you can speak with our customer care team.

Additionally, please visit our website to see which rallies our Destination America team will be attending. For a nominal fee, our service technician will service your towing system to ensure it is in proper working condition. Also, as a commitment to our customers, should you visit our factory, you can stay at our full service Blue Ox campground at no charge along with enjoying a factory tour.

Again, thank you for being our customer and for the confidence you have shown in the performance of our products. It is because of customers like you we enjoy the success we have today.

If the baseplate is in an accident, it must be replaced. DO NOT use it again! An accident can cause unseen damage and using it again could result in more damage or serious injury. DO NOT use the baseplate if it is damaged or missing parts.



© 2011 Blue Ox
One Mill Road, Industrial Park
Pender, Nebraska 68047
Phone: (402) 385-3051
Fax: (402) 385-3360
www.blueox.com