

BX2619

2010-12 Ford Taurus

(No Foglights, No Speed Control)

Installation Instructions

Serial Number

Please read BOTH these Installation Instructions and the General Instructions before attempting to install or operate this equipment.

- Blue Ox® towing products and accessories are intended to be installed by Blue Ox® Dealers who are familiar with our products and have the equipment necessary and knowledge to do “fit work”. When necessary Blue Ox® Dealers can be found at www.blueox.com or by contacting our Customer Care Department at (402) 385-3051.
- Many Blue Ox® baseplates are designed to use existing holes and hardware to mount the baseplate to the towed vehicle. Even though bolts are there, do not assume they are adequate for baseplate mounting. Always use hardware supplied in the hardware kit and existing hardware specified in the Baseplate Installation Instructions.

Attachment Tab Height: 13 1/2”
Attachment Tab Width: 26”

Bolt Torque Specifications
Torque in Foot-Pounds for Metric Bolts

Bolt Size	Grade 8.8	Grade 10.9
6MM	6	8
8MM	16	22
10MM	31	40
12MM	54	70
14MM	89	117

Confirm the towability and pre-towing procedures for your vehicle with the owner’s manual or contact the vehicle’s manufacturer for specific towing procedures.

Do not use the towed vehicle for storing luggage, equipment, etc. This may cause you to exceed the towing capacity of the tow bar, baseplate, and its accessories.

Bolt Torque Specifications
Torque in Foot-Pounds for Inch Bolts

Bolt Size	Grade 5	Grade 8
1/4”	10	14
5/16”	19	29
3/8”	33	47
7/16”	54	78
1/2”	78	119
5/8”	154	230



If the front of your vehicle looks different than this, call us at (402) 385-3051.

! WARNING

Failure to read and follow these instructions could result in separation of the towed vehicle from the tow bar, causing property damage, loss of towed vehicle, personal injury or death.

BX2619

2010-12 Ford Taurus

(No Foglights, No Speed Control)

Installation Instructions

Parts List

Ref. No.	Qty.	Part #	Description
1	1	61-6732	WLDM'T, BP, BX2619
2	10	61-5208	WLDT, NUT PLT, 1/4X1X1, 3/8" BLT WIR
3	4	201-0368	3/8-16 X 1 1/4" HEX HEAD BOLT,GRD. 5
4	2	201-0444	3/8-16 X 2 HEX BOLT GRADE 5 ZP.
5	4	201-0336	3/8-16 X 2 1/2 HEX BOLT GRD. 5 ZP.
6	10	203-0010	3/8 LOCK WASHER, ZP
7	15	203-0003	3/8 FLAT WASHER, ZP
8	2	201-0553	1/4-20 X 1/2 HX.WSHD.TYPE F TCS, ZP
9	2	201-0192	10-32 X 1/2" SLOT, RD. HD. SCREW
10	2	203-0054	#10 LOCK WASHER
11	2	202-0047	#10-32 HEX NUT
12	2	101-5822	ADAPTER, 4 WAY CONNECTOR
13	2	62-3468	ATT TAB ASSY, REM, SF/SB, 1 HOLE
	2	226-0046	BASEPLATE SAFETY CABLE, 36" CL III (Not Shown)
	2	229-0359	QUICKLINK, 3/8, ZP (Not Shown)
	2	290-0437	RECEIVER, CAP PLUG (BLK) (Not Shown)

Tools Required

8mm Socket	Flat Screw Driver
10mm Socket	Phillips Screwdriver
11mm Socket	Pliers
9/16" Socket/Wrench	Hack Saw blade
Large Vise Grip	1 1/4" Hole Saw
Drill	13/32" Drill Bit
Loctite® RED	

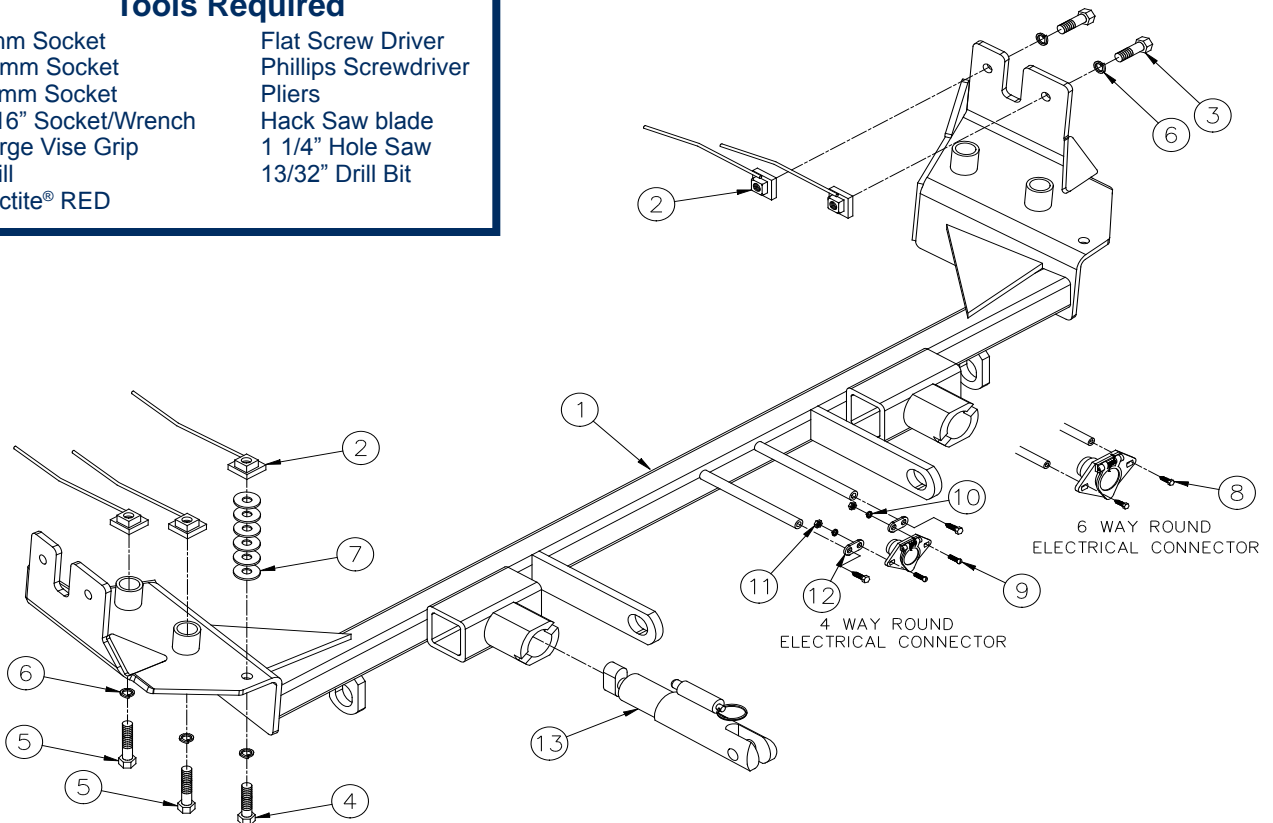

Important:

Use only genuine factory replacement parts on your baseplate. Do **NOT** substitute homemade or non-typical parts. If a bolt is lost or in need of replacement, for your safety and the preservation of your baseplate, be sure to use a replacement bolt of the same grade (In most cases it will be Grade 5, please reference the parts list above). Replacement parts may be ordered through your nearest Blue Ox® Dealer or Distributor. Failing to follow and/or altering these installation instructions in either installation or required equipment will void the manufacturer's warranty.

BX2619

2010-12 Ford Taurus

(No Foglights, No Speed Control)

Installation Instructions

Vehicle Weight: Due to the design of the removable tabs, the RangeFinderII and Ambassador tow bars can not be used. Adapters, except the BX8833 and BX88151, can not be used with this baseplate.

Installation Notes: The fascia, guard, washer reservoir, bolts, push pins and screws are removed for installation. Drilling is required. Trimming is required.

The dimensional variations between otherwise identical vehicles can be considerable. While the baseplate was designed for easy installation, it may be necessary to tailor the baseplate slightly to compensate for auto manufacturer's tolerances. These minor adjustments may include filing a hole slightly, bending electrical rods or bending end plates.

The BX8848 4-Diode Wiring Kit is recommended for this vehicle.

Do not use the towed vehicle for storing luggage, equipment, etc. This may cause you to exceed the towing capacity of the tow bar, baseplate, and its accessories.

Handling of some cosmetic parts when installing this product may require the use of protective covers, rags, specialty tools, etc. to prevent damage.

Installation Instructions:

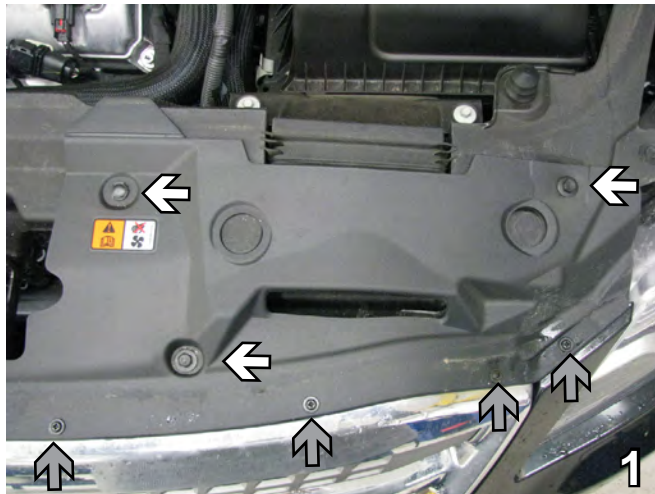

1. Using a 10mm socket, remove two metric bolts from the plastic on top of the fascia. Also remove the one push pin at the top center. Using a Phillips screwdriver, remove the four screws from around the edge (grey arrows). Do this to both sides of the vehicle. Set bolts, push pins and screws aside to be reinstalled later.
2. Using a Phillips screwdriver, remove three screws, located just forward of the front tire. Do this to both sides of the vehicle. Set screws aside to be reinstalled later.

BX2619

2010-12 Ford Taurus

(No Foglights, No Speed Control)

Installation Instructions



3. In the corner forward of the front tire, remove the push pin. Do this on both sides. Set push pins aside to be reinstalled later.



4. Underneath the vehicle in front of the tire, using a 8mm socket remove the bolt in the corner. Do this on both sides. Set the bolts aside to be reinstalled later.

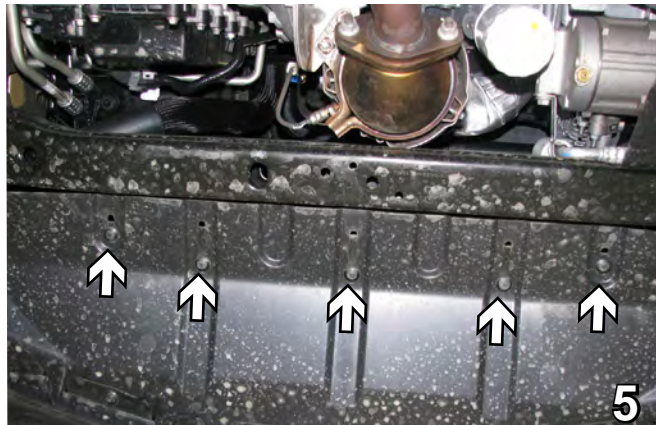

5. Underneath the vehicle across the middle, remove five push pins. Set push pins and the plastic guard aside to be reinstalled later.



6. On the passenger side in order to remove the washer reservoir, remove the two bolts from the left side using an 11mm socket. (Second bolt located on Step 7 gray arrow.) Set bolts aside to be reinstalled later.

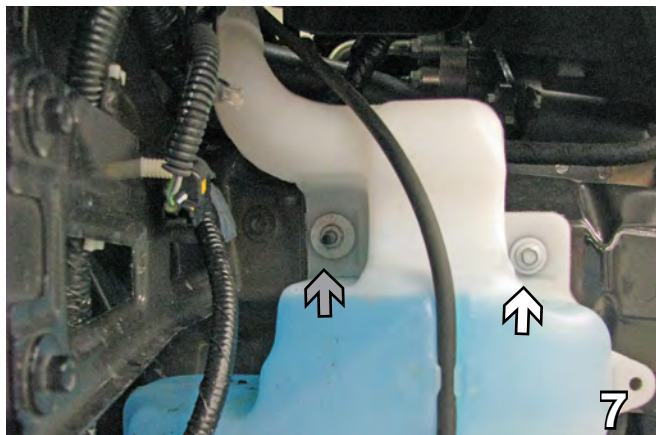

7. Continuing with the washer reservoir, use an 8mm socket to remove the top right metric bolt which will not be reinstalled. Unplug everything and completely remove. Plug the hoses to avoid losing the fluid. Set the washer reservoir aside to be reinstalled.

BX2619

2010-12 Ford Taurus

(No Foglights, No Speed Control)

Installation Instructions

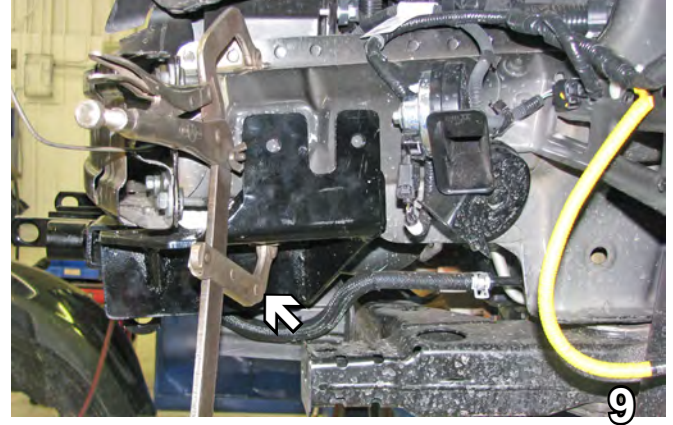
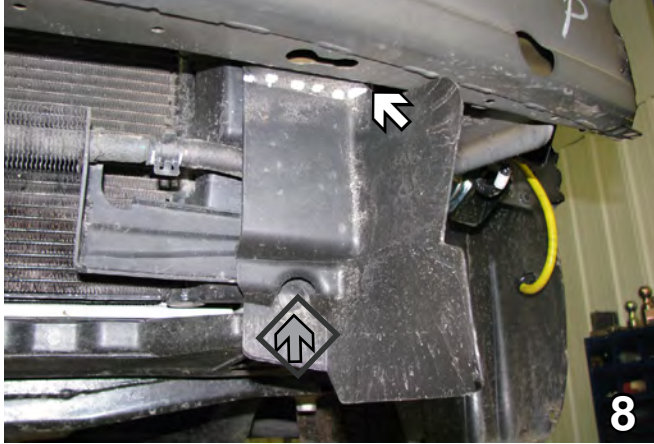

8. Under the front bumper, using a hack saw blade cut the piece of plastic flush with the bottom of the bumper. Using a flat screwdriver, remove the push pin (gray arrow). Do this on both sides. Remove the plastic and discard pieces and pins, they will not be reused.
9. Slide the base plate straight up from the bottom and clamp.

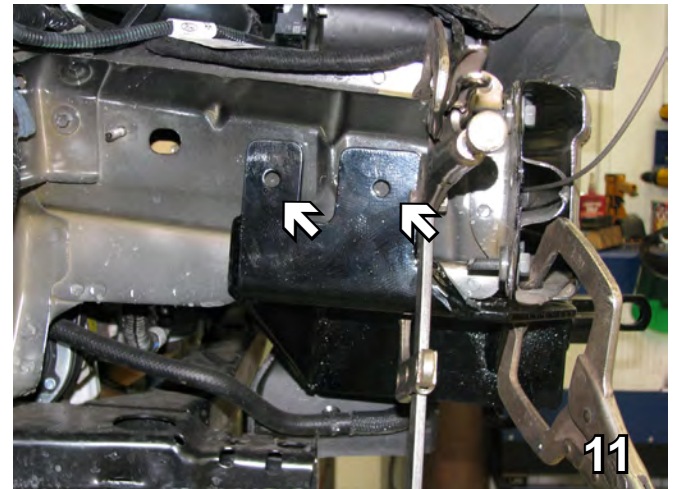
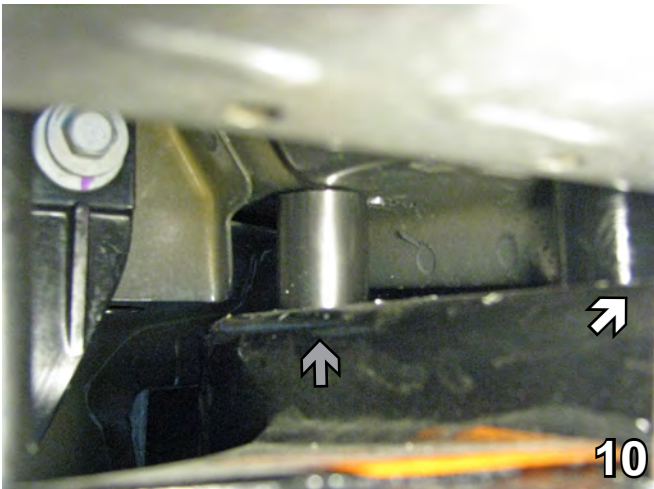

10. Underneath the base plate, drill the front hole (white arrow) using a 13/32" drill bit. Start a 3/8"-16 x 2 1/2" bolt in the hole. Drill the two remaining holes. Use 3/8"-16 x 2 1/2" bolt for the back hole (gray arrow). They both need 3/8" lock washers and 3/8" nut plates, tighten with Loctite Red. Do the same on both sides of the vehicle.
11. Be sure the base plate is level across the top, and up as far as possible. Both holes need to be drilled with a 13/32" drill bit. First drill a hole across the side and start a 3/8"-16 x 1 1/4" bolt with a 3/8" lock washer and a 3/8" nut plate, inserted into the 1 1/4" drilled hole. Continue with the second hole. Do this to both sides. Tighten with Loctite Red.

BE SURE TO USE LOCTITE® RED ON ALL BOLTS BEFORE TIGHTENING. TIGHTEN ALL BOLTS ACCORDING TO THE TORQUE CHART ON THE FRONT PAGE OF THESE INSTRUCTIONS OR ON PAGE 3 OF THE BASEPLATE TOWING GENERAL INSTRUCTIONS.

When using power drills be aware of the dangers of torque and drill bit length.

BX2619

2010-12 Ford Taurus

(No Foglights, No Speed Control)

Installation Instructions

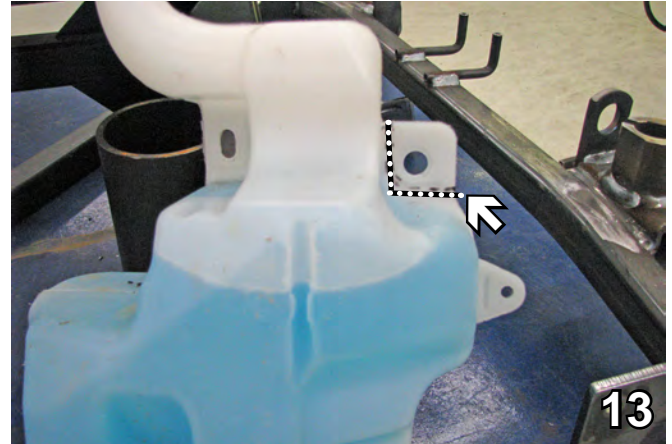
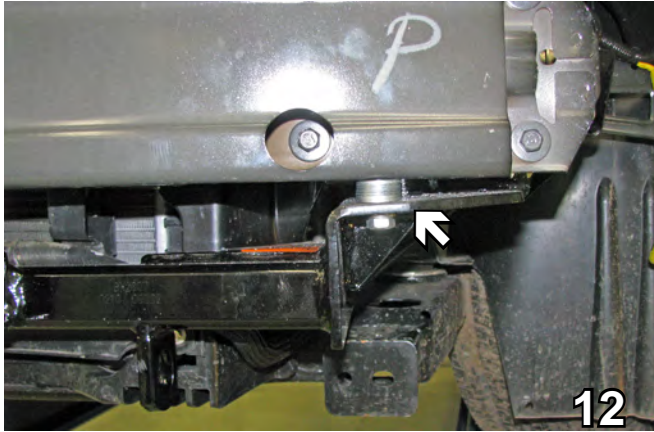

12. Insert a 3/8-16 x 2" bolt with a 3/8" lock washer into the front hole. Add as many 3/8" flat washers as necessary to keep the base plate level and attach 3/8" nut plate. Do this on both sides. Tighten with Loctite Red.
13. On the passenger side before reinstalling the washer reservoir, using a hack saw blade cut off the top right installation tab about 1 1/2" x 1 1/2" (see dotted line). Be careful not to cut into reservoir. Reinstall the water tank and connect the hoses and plug in electrical connections.

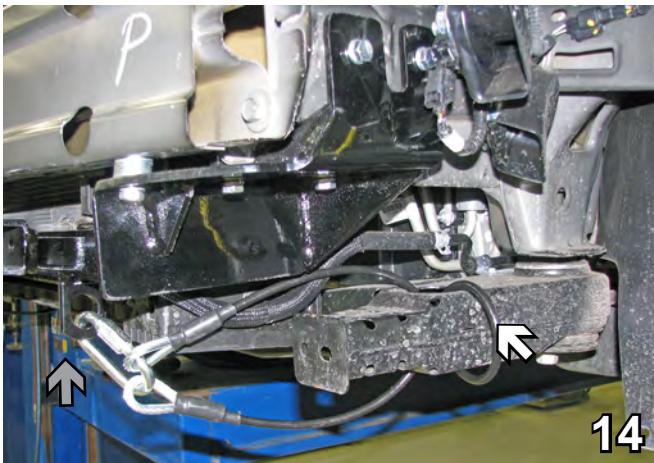

14. Attach the permanent baseplate safety cables to the provided convenience link on the baseplate (see grey arrow). The photo above shows the recommended installation of the cables to frame of vehicle (see white arrow). Additional options may interfere with suggested mounting; in this case secure the cables to a solid piece of the frame as described in the instructions included with the permanent baseplate safety cables. Be sure the safety cables do not rub against any hoses or moving parts. Do this to both sides of the vehicle.
15. On the back side of the fascia, using a hack saw blade trim the plastic piece as shown. Do this on both sides.
16. Reinstall fascia, guard, bolts, push pins and screws. The installation of the baseplate is complete.

Install the tow bar and safety cables according to the instructions provided in their packages. When demonstrating this to the customer, be sure to include all the contents and packages.

Do NOT substitute other devices if the tow bar pins and clips are misplaced.

BX2619

2010-12 Ford Taurus

(No Foglights, No Speed Control)

Installation Instructions

DEALER or INSTALLER:
Be certain the user receives the instruction sheets for their products.

Be sure that **ALL** electrical connections are plugged in properly and functioning **BEFORE** installing the fascia.



CUSTOMER SERVICE COMMITMENT

Blue Ox is committed to providing you with exceptional customer care throughout your lifetime with our products. Our team is here to assist you with any questions you may have regarding the performance of your product. Simply call (402) 385-3051 and you can speak with our customer care team.

Additionally, please visit our website to see which rallies our Destination America team will be attending. For a nominal fee, our service technician will service your towing system to ensure it's in proper working condition. Also, as a commitment to our customers, should you visit our factory, you can stay at our full service Blue Ox campground at no charge along with enjoying a factory tour.

Again, thank you for being our customer and for the confidence you have shown in the performance of our products. It is because of customers like you we enjoy the success we have today.

If the baseplate is in an accident, it must be replaced. DO NOT use it again! An accident can cause unseen damage and using it again could result in more damage or serious injury. DO NOT use the baseplate if it is damaged or missing parts.



© 2011 Blue Ox
One Mill Road, Industrial Park
Pender, Nebraska 68047
Phone: (402) 385-3051
Fax: (402) 385-3360
www.blueox.com