



BX3317

2002-'06 Old Style Saturn Vue No Red Line Edition Installation Instructions

Serial Number

Please read BOTH these Installation Instructions and the General Instructions before attempting to install or operate this equipment.

- Blue Ox® towing products and accessories are intended to be installed by Blue Ox® Dealers who are familiar with our products and have the equipment necessary and knowledge to do "fit work". When necessary Blue Ox® Dealers can be found at www.blueox.com or by contacting our 24/7 Customer Care Department at (402) 385-3051.
- Many Blue Ox® Baseplates are designed to use existing holes and hardware to mount the baseplate to the towed vehicle. Even though bolts are there, do not assume they are adequate for baseplate mounting. Always use hardware supplied in the hardware kit and existing hardware specified in the Baseplate Installation Instructions.

Attachment Tab Height: 15"
Attachment Tab Width: 18"

Bolt Torque Specifications
Torque in Foot-Pounds per Metric Bolts

Bolt Size	Grade 8.8	Grade 10.9
6MM	6	8
8MM	16	22
10MM	31	40
12MM	54	70
14MM	89	117

Confirm the towability and pre-towing procedures for your vehicle with the owner's manual or contact the vehicle's manufacturer for specific towing procedures.

Bolt Torque Specifications
Torque in Foot-Pounds per Inch Bolts

Bolt Size	Grade 5	Grade 8
1/4"	10	14
5/16"	19	29
3/8"	33	47
7/16"	54	78
1/2"	78	119
5/8"	154	230

! WARNING

Failure to read and follow these instructions could result in separation of the towed vehicle from the tow bar, causing property damage, loss of towed vehicle, personal injury or death.



BX3317

2002-'06 Old Style Saturn Vue No Red Line Edition Installation Instructions

Parts List

Ref. No.	Qty.	Part #	Description
1	1	61-5757	Weldment, Baseplate, BX3317
2	6	61-5208	3/8-16 Nutplate, with 14" Wire
3	6	201-0444	3/8-16 x 2" Hex Bolt, Grd. 5, ZP
4	6	203-0010	3/8" Lock Washer, ZP
5	2	201-0553	1/4-20 x 1/2" Hx. Wshd, Type F Screw, ZP
6	2	201-0192	#10-32 x 1/2" Slot, Rd. Hd. Screw, ZP
7	2	203-0054	#10 Lock Washer, ZP
8	2	202-0047	#10-32 Hex Nut, ZP
9	2	101-5822	Adapter, 4 Way Connector
10	2	62-3469	Attachment Assembly, LB/ SF (R)
11	1	101-6135	Electrical Bracket, 90 degrees
12	4	201-0071	1/4-20 x 1" Hex Bolt, Grade 5, ZP
13	4	203-0008	1/4" Lock Washer, ZP
14	4	203-0001	1/4" Flat Washer, ZP
15	4	202-0069	1/4-20 Nut Flange Whiz Lock Nut, ZP
16	1	101-6845	Electrical Bracket
	2	226-0046	Baseplate Safety Cable, 36" CL III (Not Shown)
	2	229-0359	Quicklink, 3/8, ZP (Not Shown)
	2	290-0437	Cap Plug, Black (Not Shown)

Tools Required

- 7MM Socket
- 10MM Socket
- 9/16" Socket
- 13/32" Drill Bit
- 7/16" Socket
- 15 Torx Wrench
- Vise Grips
- Reciprocating Saw
- Utility Knife
- Loctite® RED

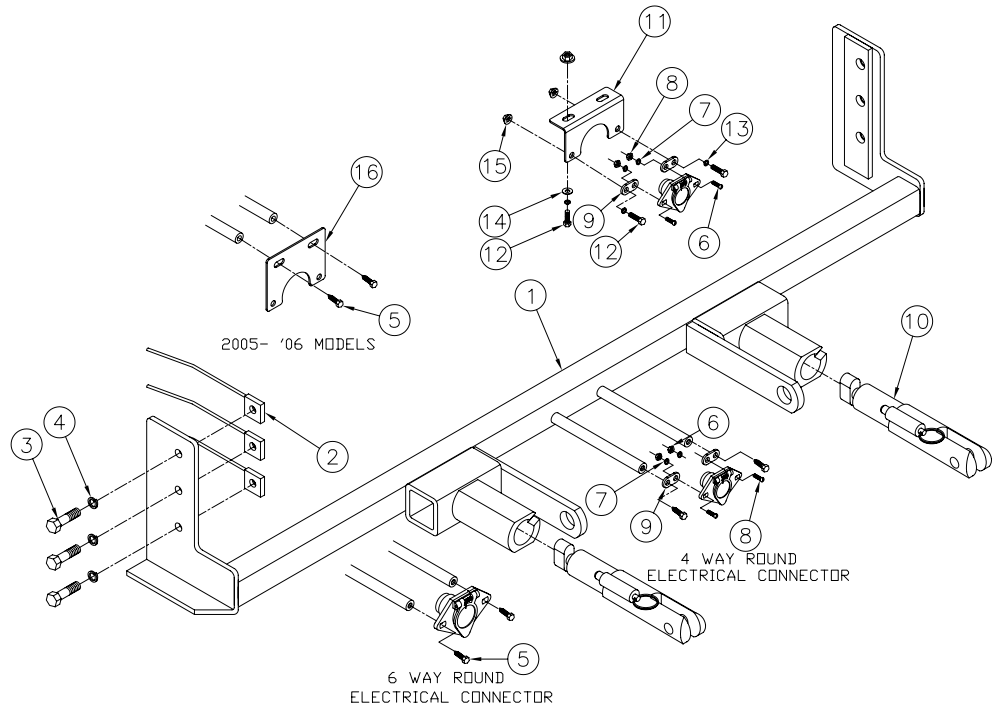

Important:

Use only genuine factory replacement parts on your baseplate. Do NOT substitute homemade or non-typical parts. If a bolt is lost or in need of replacement, for your safety and the preservation of your baseplate, be sure to use a replacement bolt of the same grade (In most cases it will be Grade 5, please reference the parts list above). Replacement parts may be ordered through your nearest Blue Ox® Dealer or Distributor, or call our 24/7 Customer Care Team at (402)385-3051.



BX3317

2002-'06 Old Style Saturn Vue No Red Line Edition Installation Instructions

Attachment Tabs:

Motorhome mount tow bars are recommended for use with this baseplate. Due to the design of the removable tabs, the RangeFinder II, Adventurer, and Ambassador tow bars can not be used. The Acclaim tow bar may be used but will not fold and store on the front of the vehicle. Adapters, except for the BX8833 and the BX88151, can not be used with this baseplate.

Instructions:

The front fascia, blinker assemblies, styrofoam bumper and lower air dam are removed and reinstalled during the baseplate installation. Drilling is required. Some vehicles fascia's may need trimming.

The dimensional variations between otherwise identical vehicles can be considerable. While the baseplate was designed for easy installation, it may be necessary to tailor the baseplate slightly to compensate for auto manufacturer's tolerances. These minor adjustments may include filing a hole slightly, bending electrical rods, and/ or bending end plates.

The Bx8869 Bulb and Socket Wiring Kit is recommended for this vehicle.

Installation Instructions



1. **2002-05 Models Only:** Using the 10MM socket, remove the metric bolt from the blinker assembly. Remove the push pin, lift up and forward to disconnect electrical connections. Do this to both sides of the vehicle. Set blinker assemblies, bolts and push pins aside to be reinstalled later.



2. **2002-05 Models ONLY:** Remove two pushpins on the top side of the fascia, just between the headlights. Set the pushpins aside to be reinstalled later.

BX3317

2002-'06 Old Style Saturn Vue No Red Line Edition Installation Instructions



3. **2006 Models ONLY:** Remove four metric bolts from the top edge of the fascia with the 10MM socket. Set the metric bolts aside to be reinstalled later.



4. **All Models:** Remove four pushpins inside the wheel well, just forward of the front tires. Do this to both sides of the vehicle. Set the pushpins aside to be reinstalled later.



5. **All Models:** Using the 10MM socket, remove the metric bolt on the fascia corner. Do this to both sides of the vehicle. (5-A is the 2002-05 models and 5-B is the 2006 model). Set the bolts aside to be reinstalled later.



BX3317

2002-'06 Old Style Saturn Vue No Red Line Edition Installation Instructions

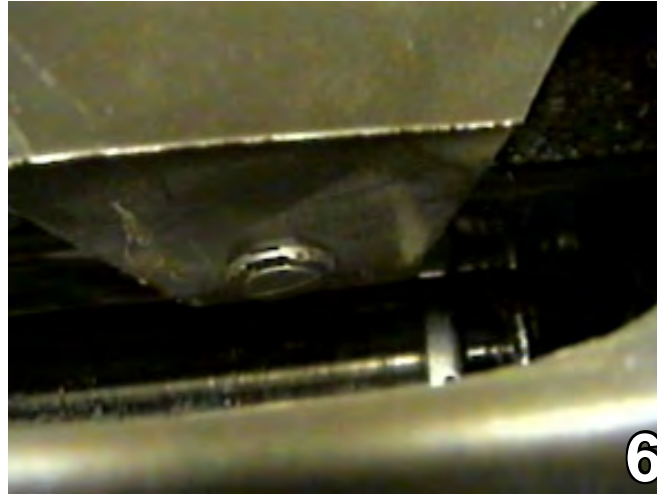

6. **2002-05 Models ONLY:** Remove two push pins from the bottom metal bumper on the fascia's lower opening. Using the 10MM socket, remove six metric bolts from the bottom side of the fascia. Set pushpins and bolts aside to be reinstalled later.

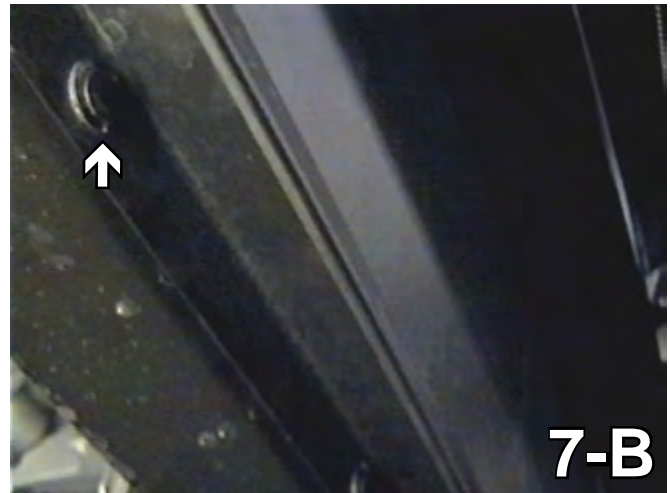
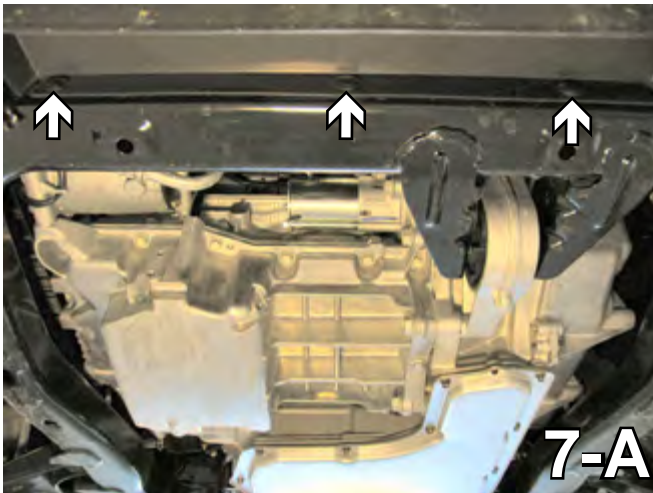

7. All Models: Remove three pushpins from under the back edge of the lower air dam. Pull air dam down and remove from vehicle. Set the pushpins and air dam aside to be reinstalled later.



BX3317

2002-'06 Old Style Saturn Vue No Red Line Edition Installation Instructions

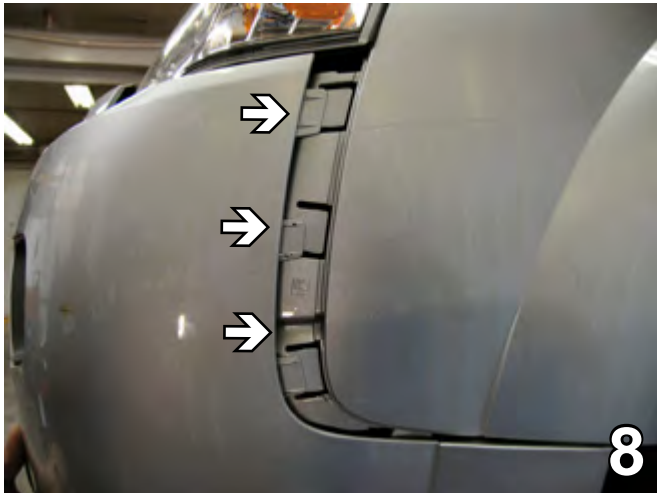

8. **All Models:** Release three clips on the back side of the fascia. Do this to both sides of the vehicle. Pull the fascia forward and set aside to be reinstalled later.



9. **All Models:** Remove two large pushpins on the front of the Styrofoam bumper. Pull forward. Set Styrofoam bumper and pushpins aside to be reinstalled later.

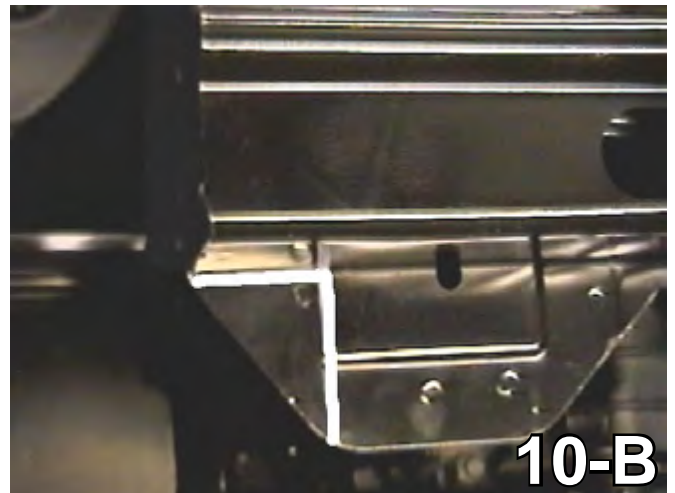

10. Using the hack saw or reciprocating saw, cut away the outside corner of the lower bumper bracket, adjacent to the outer frame. This will relieve the area for baseplate installation. Do this to both sides of the vehicle.



BX3317

2002-'06 Old Style Saturn Vue No Red Line Edition Installation Instructions



11-A

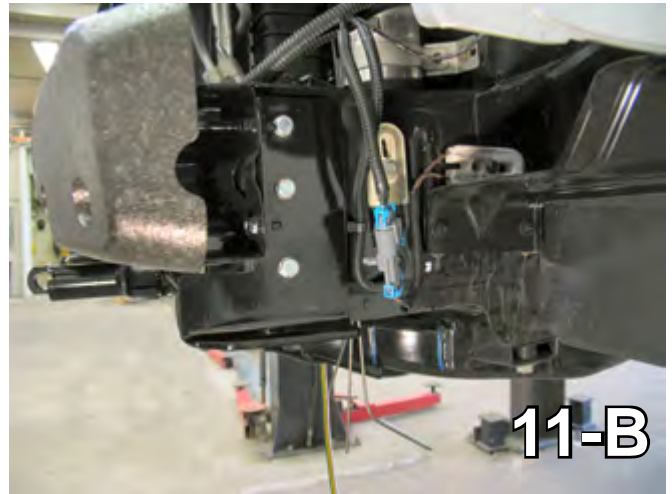

11-B

11. **All Models:** Hold the baseplate in position as far forward to back side of the metal bumper and up as far as possible, clamp in place with vise grips. Using the baseplate as a template, drill the three holes on each side with the 13/32" drill bit. Insert the 3/8-16 nut plates into the opening on the bottom of the frame rail to align with the drilled holes. Insert the 3/8-16 hex bolts and the 3/8" lock washers into the nutplates. Insert the 3/8-16 nutplate into the opening on the bottom of the frame rail and align with the drilled holes. Note: The baseplate is painted white for illustration purposes only. The actual baseplate has a black powder coat finish.

BE SURE TO USE LOCTITE® RED ON ALL BOLTS BEFORE TIGHTENING. TIGHTEN ALL BOLTS ACCORDING TO THE TORQUE CHART ON THE FRONT PAGE OF THESE INSTRUCTIONS OR ON PAGE 3 OF THE BASEPLATE TOWING GENERAL INSTRUCTIONS.



12

12. **2002-05 Models Only:** Hold the fascia in place, mark, and trim the bumper tabs as needed. Reinstall the bumper Styrofoam bumper, lower air dam, blinker assemblies and fascia.

Be sure that ALL electrical connections are plugged in properly and functioning BEFORE installing the fascia.



2005-2006 Models:
This plate is used to lower the electrical connector so that it will mount to the baseplate without interfering with the license plate.

Using the #10-32 x 1/2" Slot, Rd. Hd. Screw, #10 Lock washer and the #10-32 Hex Nut, attach this supplemental plate to the baseplate.



BX3317 2002-'06 Old Style Saturn Vue No Red Line Edition Installation Instructions



**Complete Installation
on 2006 Models**



**Complete Installation
on 2002-05 Models**

Bulb and Socket Installation Instructions



Using the 15 torx, remove two bolts and pull tail light assembly straight back. The bulb hole can be drilled in the upper cell.



**Location for the BX8869
Bulb & Socket Wiring Kit.**



BX3317

2002-'06 Old Style Saturn Vue No Red Line Edition Installation Instructions

DEALER or INSTALLER:

**Be certain the user receives the
instruction sheets for their products.**



Customer Service Commitment

Blue Ox® is focused on providing exemplary customer service, as observed in our mission statement and guiding principles. In accordance with this objective, Blue Ox® is proud to provide services such as repairs and general maintenance of Blue Ox® products at over 150 RV Rallies.

Look for our Destination America or Blue Ox® Racing service crews at the next rally or NASCAR race that you attend. If you were not present at the time of service, you will find an informative, personalized note explaining any services that may have been performed to your Blue Ox® products.

Blue Ox® also offers educational seminars at rallies and through our Parks and Resort teams. In addition, Blue Ox® customers visiting our factory may take advantage of the well-equipped Blue Ox® RV park at no charge to you, our valued and appreciated customer.



© 2005, 06 Blue Ox
One Mill Road, Industrial Park
Pender, Nebraska 68047
Phone: (402) 385-3051
Fax: (402) 385-3360
www.blueox.com