



**BX3783**

# 2007-12 Toyota Yaris Liftback Installation Instructions

Serial Number

**Attachment Tab Height: 13"**

**Attachment Tab Width: 24"**

**Please read BOTH these Installation Instructions and the General Instructions prior to installing or operating this equipment.**

1. Blue Ox® towing products and accessories are intended to be installed by Blue Ox® Dealers who are familiar with our products and have the equipment and knowledge necessary to do "fit work". If needed, Blue Ox® Dealers can be found at [www.blueox.com](http://www.blueox.com) or by contacting our Customer Care Department at (402) 385-3051.
2. Many Blue Ox® baseplates are designed to use existing holes and hardware to mount the baseplate to the towed vehicle. Even though bolts are there, do not assume they are adequate for baseplate mounting. Always use the hardware supplied in the hardware kit and existing hardware as specified in the installation instructions.

**Bolt Torque Specifications**  
Torque in Foot-Pounds for Metric Bolts

Bolt Size	Grade 8.8	Grade 10.9
6MM	6	8
8MM	16	22
10MM	31	40
12MM	54	70
14MM	89	117



**2007-11 Models**

**Bolt Torque Specifications**  
Torque in Foot-Pounds for Inch Bolts

Bolt Size	Grade 5	Grade 8
1/4"	10	14
5/16"	19	29
3/8"	33	47
7/16"	54	78
1/2"	78	119
5/8"	154	230



**2012 Models**

**Reference your vehicle owner's manual for manufacturer's towing specifications.**

**⚠ WARNING**

Failure to read and follow these instructions could result in separation of the towed vehicle from the tow bar, causing property damage, loss of towed vehicle, personal injury or death.

If the front of your vehicle looks different than this, please contact us at (402)385-3051.

**BX3783**  
**2007-12 Toyota Yaris Liftback**  
**Installation Instructions**

**Instruction Notes:** The fascia, windshield washer fluid reservoir, temperature sensor, frame extension, and passenger headlight are removed and reinstalled for the baseplate installation. Some drilling and trimming is required.

Place all components that are removed on a flat, sturdy surface. All items will be reinstalled unless otherwise noted after the baseplate is installed.

The dimensional variations between otherwise identical vehicles can be considerable. While the baseplate was designed for easy installation, it may be necessary to tailor the baseplate slightly to compensate for vehicle manufacturer's tolerances.

The BX8869 Tail Light Wiring Kit is recommended for 2007-11 Models.  
The BX8848 Tail Light Wiring Kit is recommended for 2012 Models only.

## ***NOTICE***

- Handling of some cosmetic parts when installing this product may require the use of protective covers, rags, specialty tools, etc. to prevent damage.
- When using power drills be aware of the dangers of torque and drill bit length.
- Be sure that **ALL** electrical connections are plugged in properly and functioning before reinstalling the fascia.
- Do not use the towed vehicle for storing luggage, equipment, etc. This may cause you to exceed the towing capacity of the tow bar, baseplate and its accessories.
- Be sure to use Loctite® Red on all bolts before tightening. Tighten all bolts according to the torque chart provided.
- Due to design of the removable tabs, the RangeFinderII tow bar can not be used. Adapters, except the BX8833 and BX88151, can not be used with this baseplate.

# BX3783

## 2007-12 Toyota Yaris Liftback Installation Instructions

**Tools Required**

Large Vise Grip  
Flat Screwdriver  
Utility Knife  
Reciprocating Saw  
Torque Wrench  
Drill  
Tape Measure  
Loctite® RED  
13/32" Drill Bit  
10MM Socket  
14MM Socket  
9/16" Socket  
9/16" Wrench

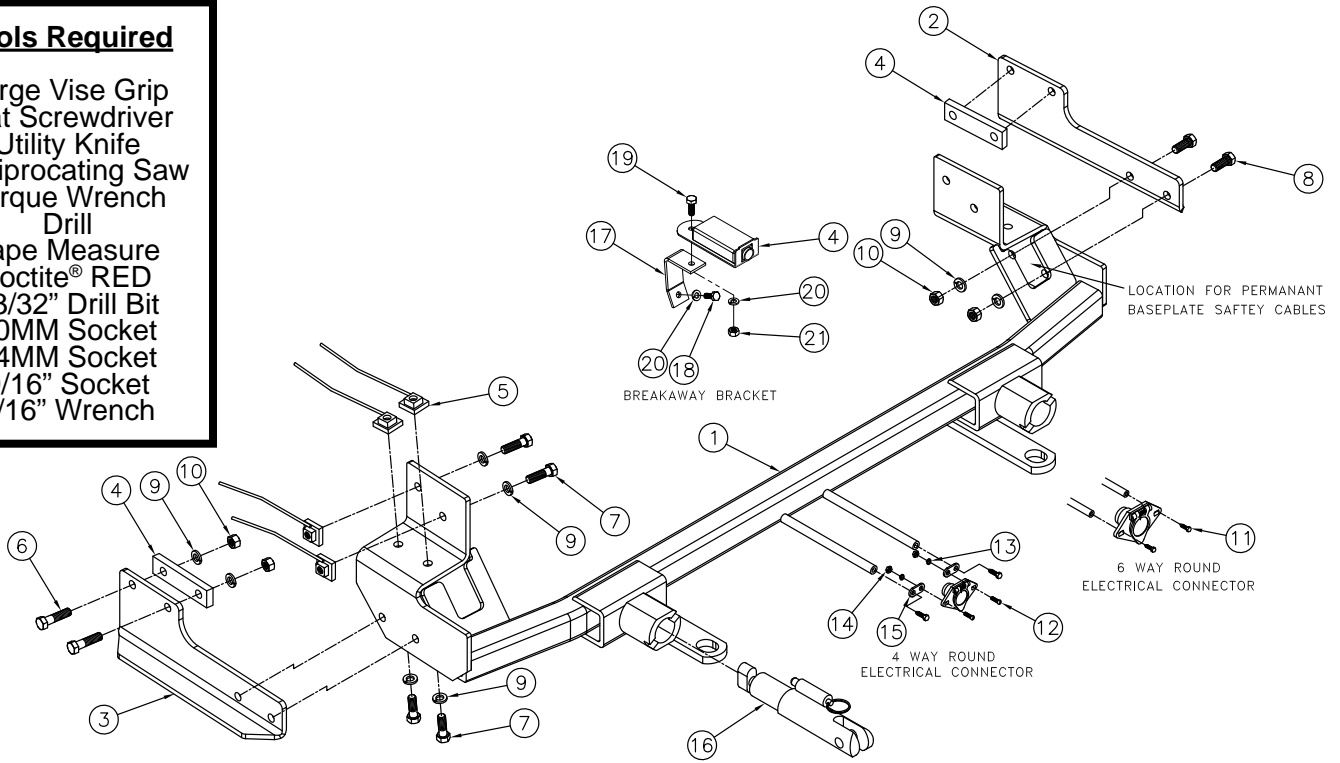

Item No.	Part No.	Description	Qty.
1.....	61-6605	BX3783 Baseplate.....	1
2.....	101-7241	Support Plate, DS BX3780.....	1
3.....	101-7242	Support Plate, PS, BX3780.....	1
4.....	102-6861	BX3778 Spacer Plate.....	2
5.....	61-5208	3/8"-16 Nut Plate, w/14" Wire.....	8
6.....	201-0440	3/8"-16 x 1-1/2" Hex Head Bolt, Grade 5, ZP.....	4
7.....	201-0368	3/8"-16 x 1-1/4" Hex Head Bolt, Grade 5, ZP.....	8
8.....	201-0443	3/8"-16 x 1" Hex Head Bolt, Grade 5, ZP.....	4
9.....	203-0010	3/8" Lock Washer, ZP.....	16
10.....	202-0003	3/8"-16 Hex Nut, ZP.....	8
11.....	201-0553	1/4"-20 x 1/2" Hex Wshd Bolt Type F TCS, ZP.....	2
12.....	201-0192	#10-32 x 1/2" Round Slot Head Screw.....	2
13.....	203-0054	#10 Lock Washer.....	2
14.....	202-0047	#10-32 Hex Nut.....	2
15.....	101-5822	4 Way Connector Adapter.....	2
16.....	62-3468	Attachment Tab Assembly with Hole.....	2
17.....	102-7180	BX3783 Breakaway Bracket.....	1
18.....	201-0461	6MM-1.0 x 16MM Hex Cap Bolt, Grade 8.8, ZP.....	1
19.....	201-0050	1/4"-20 x 3/4" Hex Head Bolt, Grade 5, ZP.....	1
20.....	203-0008	1/4" Lock Washer, ZP.....	2
21.....	202-0102	1/4"-20 Nylon Hex Nut, ZP.....	1
22.....	226-0046(not shown)	Class III Safety Cables.....	2
23.....	229-0359(not shown)	3/8" Quicklink, ZP.....	2
24.....	290-0437(not shown)	Black Cap Plug Receiver.....	2
25.....	201-0655(not shown)	6MM-1.0 x 30MM Hex Head Bolt, Grade 8.8.....	2
26.....	203-0001(not shown)	1/4" Flat Washer.....	12

BX3783  
2007-12 Toyota Yaris Liftback  
Installation Instructions



1. Push in center to remove plastic push pins from top edge of fascia. Set push pins aside to be reinstalled later.  
**2007-11:** Five (5) push pins total  
**2012:** Seven (7) push pins total



- 2A. Just forward of the front tire next to the wheel well edge on the back side of the fascia, remove another push pin. Do this on both sides of vehicle. Set push pins aside to be reinstalled later. **2007-11 Models**
- 2B. Just forward of the front tire next to the wheel well edge on the back side of the fascia, unsnap fascia from wheel well. **2012 Models**



3. Remove eight (8) metric bolts from lower edge of fascia all the way around using a 10MM socket. Set bolts aside for later reinstallation.

BX3783  
2007-12 Toyota Yaris Liftback  
Installation Instructions



4. Pull fascia corners out to the side of the vehicle on both sides, then forward. Set fascia aside carefully for later reinstallation.

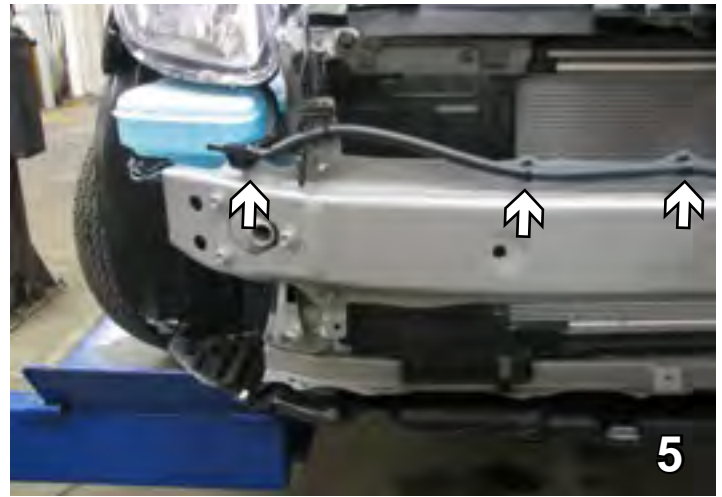

5. On the back side of the bumper, unhook five (5) hose clamps by squeezing together. **2007-11 Models Only**

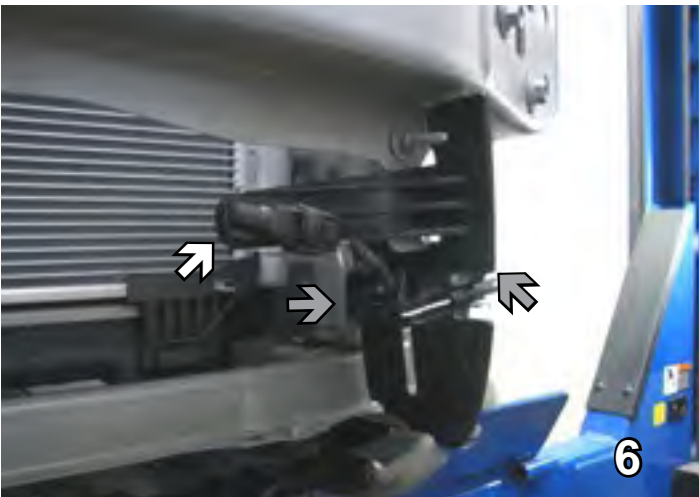

6. On the driver's side, remove the temperature sensor (white arrow). Unhook the plastic guard under the bumper (gray arrow) on both sides and set aside. Set sensor aside for later reinstallation.

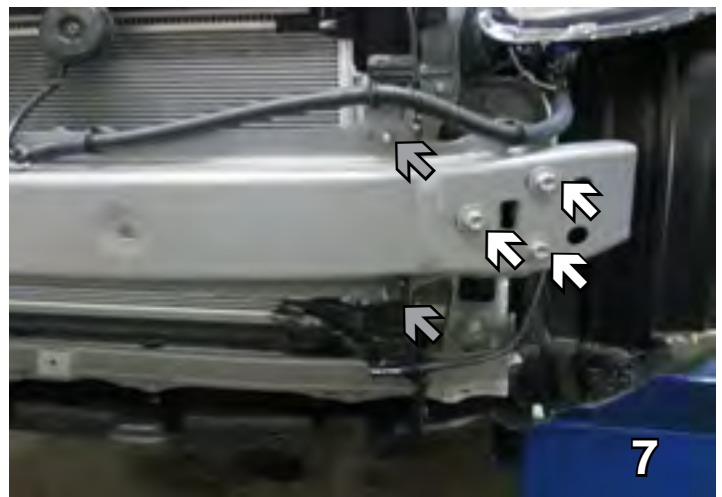

7. Using a 14MM socket, remove three (3) bolts (white arrows) from the bumper core. Using a 10MM socket, remove two (2) hex nuts (grey arrows). Do this on both sides. Set bumper, bolts and nuts aside for later reinstallation.

BX3783  
2007-12 Toyota Yaris Liftback  
Installation Instructions



8. On the passenger side, use a 10MM socket to remove the two (2) top screws and one (1) lower screw from headlight. Unhook wiring and set headlight and bolts aside for later reinstallation.

9. On the top of the washer reservoir, squeeze the tab to release the hose.

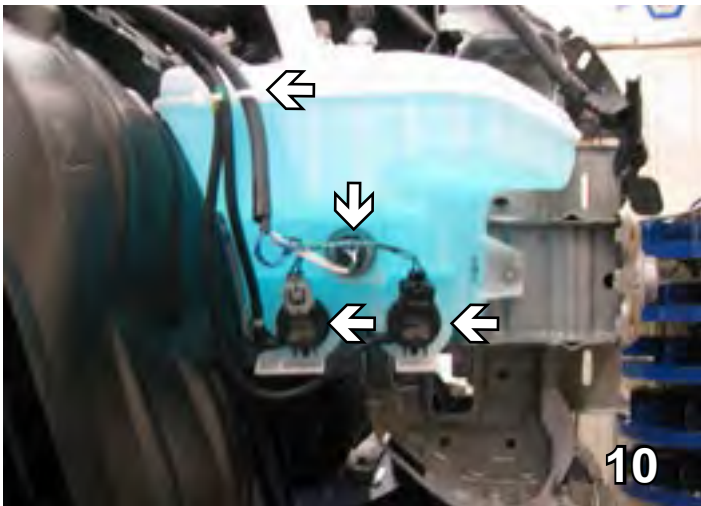

10. Unhook the two (2) wires, unplug the electrical connections and the hoses. Cap the fluid openings.

11. On the passenger side, use a 10MM socket to remove the two (2) bolts on either side of the washer reservoir. Set reservoir and bolts aside for later reinstallation.

BX3783  
2007-12 Toyota Yaris Liftback  
Installation Instructions



12. Using a 14MM socket, remove four (4) bolts from the frame extension, two on top and two on the bottom. Do this on both sides. Set extension and bolts aside for later reinstallation.



13. Measure up 5/8" from the bottom and across on the lower frame support webbing. Use a reciprocating saw to cut out the notch. Do this on both sides.



14. Measure up 2" on the edge of the bumper core. Use a reciprocating saw to cut flush with the bumper. Do this on both sides.

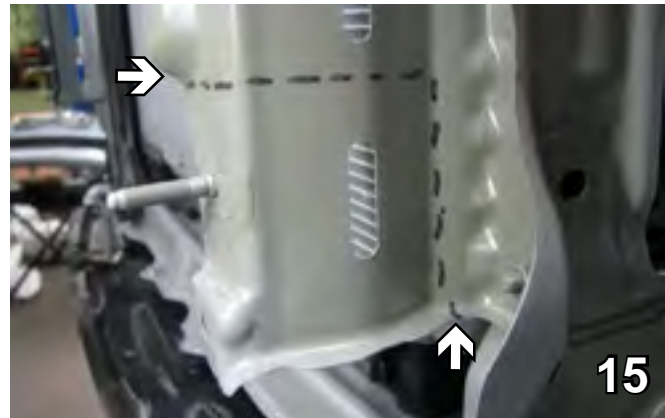

15. On the frame, use a reciprocating saw to trim straight across under the little hump and back to the groove then straight down. Do this on both sides.

**Using a good quality paint, spray cut edges of frame to prevent rusting.**

16. Pound in the protruding frame connector so that it is level with both edges. Do this on both sides of the vehicle.  
**2007-11 Models only**



BX3783  
2007-12 Toyota Yaris Liftback  
Installation Instructions

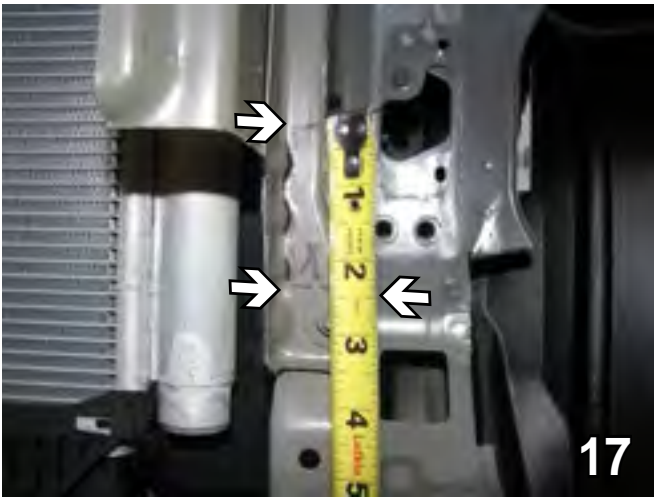

17. Using a reciprocating saw, cut above the bolt in the frame across to the rib then up 2 1/2" along the edge of the rib and across to remove the notch. Do this on both sides.

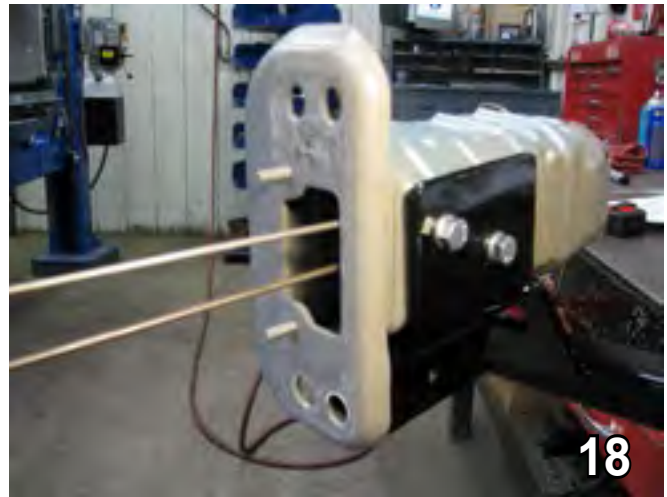

18. Line up the two big existing holes in the frame extension with the side baseplate holes. Start the 3/8"-16 x 1 1/4" bolts with 3/8" lock washers and on the inside of the frame use 3/8"-16 nut plates. Use Loctite Red on all bolts. Do this on both sides.



19. Using the baseplate as a template, drill the two bottom holes with a 13/32" drill bit into the frame extension. Install 3/8"-16 x 1 1/4" bolts and 3/8" lock washers into drilled holes. Then tighten into 3/8" nut plates inside the extension. Use Loctite Red on all bolts. Do this to both sides.

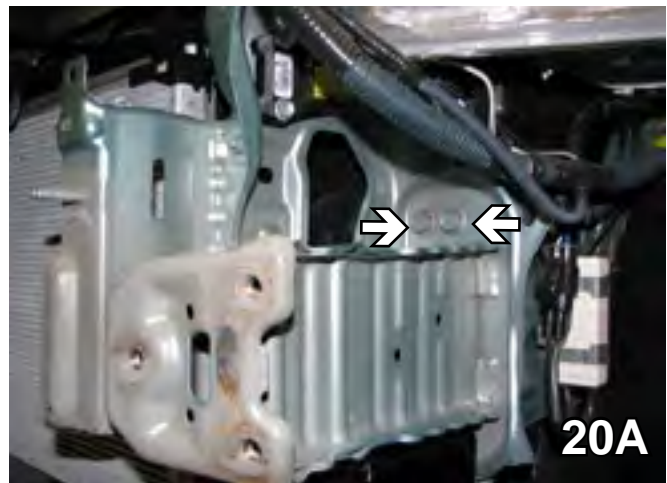

20. Reinstall the frame extension, put the bolts back in, two (2) on the top and two (2) on the bottom. Do this on both sides.

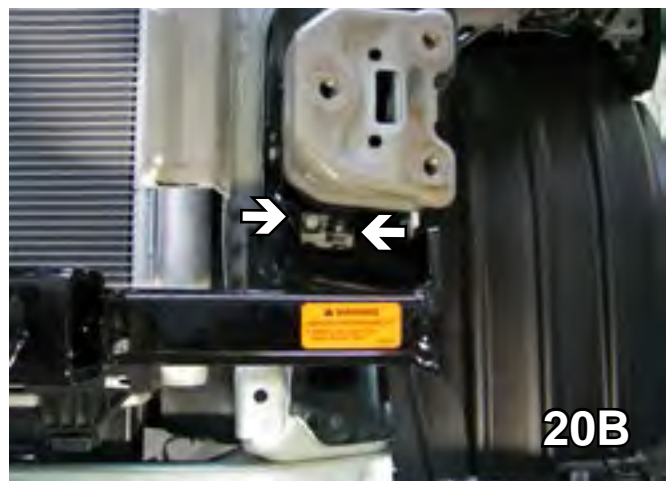



BX3783  
2007-12 Toyota Yaris Liftback  
Installation Instructions

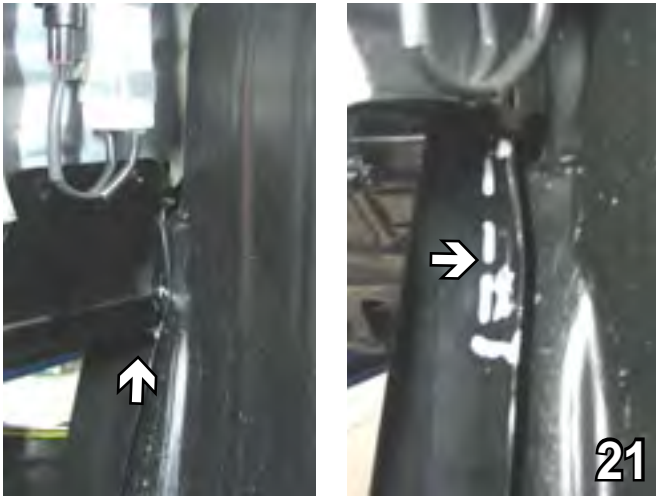

21. Hold up the plate support and mark the location. Trim the plastic. Do this on both sides.

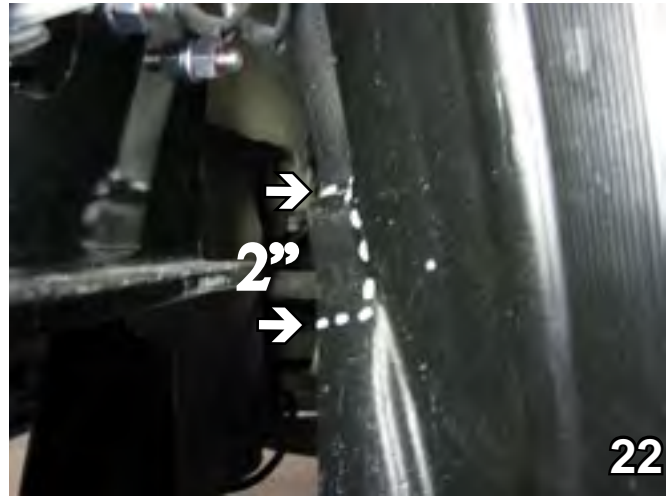

22. Trim the plastic from in front of the fender well, from the crease down 2" and over to the ridge. Do this on both sides.

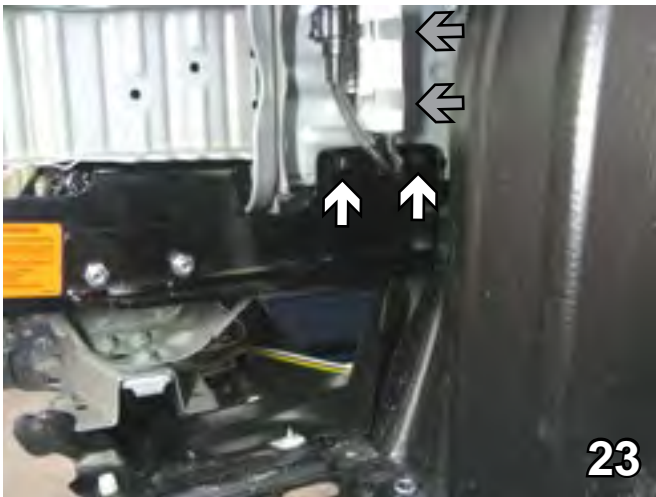

23. Temporally bolt tight the lower bracket to the baseplate with just 3/8"-16 x 1" bolts and 3/8"hex nuts only. Align the back of the bracket holes to the center of the lower frame webbing. Use as a template to drill the back two holes with a 13/32" drill bit (white arrows). Do this on both sides. On the driver's side only, use a 10MM socket to remove the bolts (gray arrows) holding the sensor so that it can be set out of the way while drilling then replace.



24. Loosen the front two bolts (gray arrows). Insert in the back 3/8"-16 x 1 1/2" bolts, the spacer plates, 3/8" lock washers and 3/8" hex nuts. Loctite Red all bolts and tighten. Then install 3/8" lock washers onto the front two (2) 3/8"-16 x 1" bolts (gray arrows) and 3/8" hex nuts, Loctite Red all bolts and tighten. Do this on both sides.

BX3783  
2007-12 Toyota Yaris Liftback  
Installation Instructions



25. Zip tie the temperature sensor around the baseplate. **2007-11 Models**  
Attach temperature sensor into existing body hole using existing clip. **2012 Models**  
Put the bumper back. Plug the cables back in on top of the bumper.

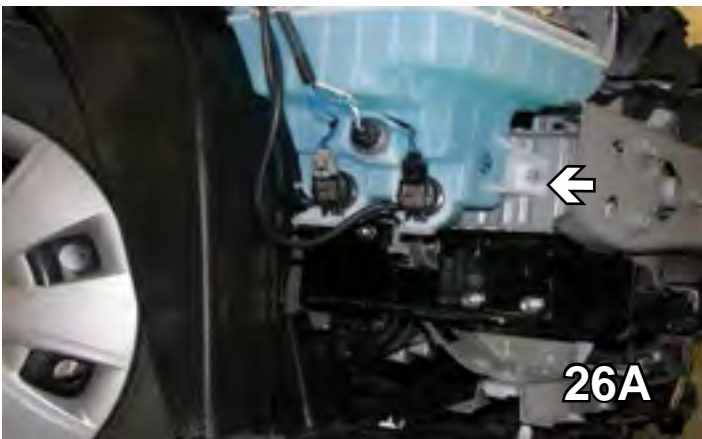

26. **2007-11 Models (28A)**  
On the passenger side, reinstall the washer reservoir. Reconnect the electrical connections and the hoses.

**2012 Models (26B)**

Trim washer reservoir as shown. (Left)  
Using two (2) 6MM-1.0 x 30MM bolts and 1/4" flat washers, re-attach the washer reservoir spaced as needed. Reconnect the electrical connections and the hoses. (Right)



27. Reinstall the headlight. Reconnect all electrical connections and clamps.

BX3783  
2007-12 Toyota Yaris Liftback  
Installation Instructions



28. Attach the permanent baseplate safety cables to the provided convenience link on the baseplate (see grey arrow). The photo above shows the recommended installation of the cables to frame of vehicle (see white arrow). Additional options may interfere with suggested mounting; in this case secure the cables to a solid piece of the frame as described in the instructions included with the permanent baseplate safety cables. Be sure the safety cables do not rub against any hoses or moving parts. Do this to both sides of the vehicle.

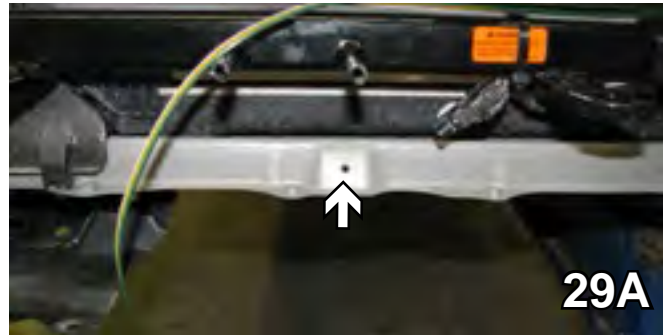

29. Using the hole in the middle of the lower frame. Attach the breakaway bracket with a 6MM-1 x 16MM hex bolt and a 1/4" lock washer inserted into the hole.



30. Attach the breakaway to the bracket with a 1/4"-20 x 3/4" hex bolt, 1/4" lock washer and 1/4"-20 hex nut.

31. Reinstall the fascia.

32. Dealer or installer be certain the user receives the instruction sheet.

**BX3783**  
**2007-12 Toyota Yaris Liftback**  
**Installation Instructions**

Install the tow bar and safety cables according to the instructions provided in their packages. When demonstrating to customer, be sure to include all original content and packages. Do **NOT** substitute other devices if the tow bar pins and clips are misplaced.



**CUSTOMER SERVICE COMMITMENT**

Blue Ox® is committed to providing you with exceptional customer care throughout your lifetime with our products. Our team is here to assist you with any questions you may have regarding the performance of your product. Simply call (402) 385-3051 and you can speak with our customer care team.

Additionally, please visit our website to see which rallies our Destination America team will be attending. For a nominal fee, our service technician will service your towing system to ensure it's in proper working condition. Also, as a commitment to our customers, should you visit our factory, you can stay at our full service Blue Ox® campground at no charge along with enjoying a factory tour.

Again, thank you for being our customer and for the confidence you have shown in the performance of our products. It is because of customers like you we enjoy the success we have today.

© 2012 Blue Ox  
One Mill Road, Industrial Park  
Pender, Nebraska 68047  
Phone: (402) 385-3051  
Fax: (402) 385-3360  
[www.blueox.com](http://www.blueox.com)