

Please read **BOTH** these Installation Instructions and the General Instructions before attempting to install or operate this equipment.

- Blue Ox® towing products and accessories are intended to be installed by Blue Ox® Dealers who are familiar with our products and have the equipment necessary and knowledge to do "fit work". When necessary Blue Ox® Dealers can be found at [www.blueox.com](http://www.blueox.com) or by contacting our Customer Care Department at (402) 385-3051.
- Many Blue Ox® Baseplates are designed to use existing holes and hardware to mount the baseplate to the towed vehicle. Even though bolts are there, do not assume they are adequate for baseplate mounting. Always use hardware supplied in the hardware kit and existing hardware specified in the Baseplate Installation Instructions.

Attachment Tab Height: 12.5"

Attachment Tab Width: 22"

### Bolt Torque Specifications

Torque in Foot-Pounds for Metric Bolts

Bolt Size	Grade 8.8	Grade 10.9
6MM	6	8
8MM	16	22
10MM	31	40
12MM	54	70
14MM	89	117

Confirm the

and pre-towing procedures for your vehicle with the owner's manual or contact the vehicle's manufacturer for specific towing procedures.

### Bolt Torque Specifications

Torque in Foot-Pounds for Inch Bolts

Bolt Size	Grade 5	Grade 8
1/4"	10	14
5/16"	19	29
3/8"	33	47
7/16"	54	78
1/2"	78	119
5/8"	154	230

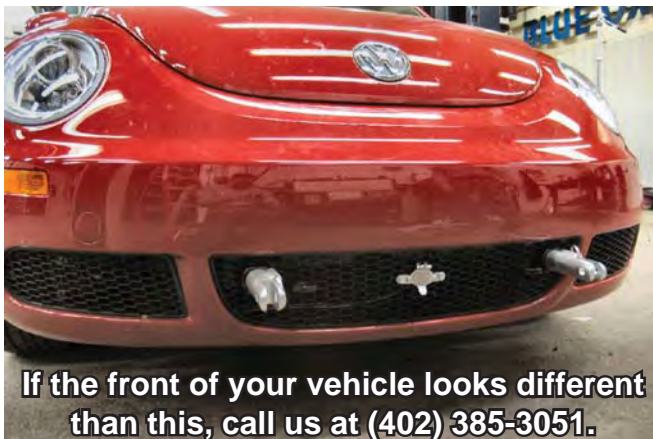

If the front of your vehicle looks different than this, call us at (402) 385-3051.

## ! WARNING

Failure to read and follow these instructions could result in separation of the towed vehicle from the tow bar, causing property damage, loss of towed vehicle, personal injury or death.

# BX3824

## 2006-09 VW Beetle

### Installation Instructions

## Parts List

Ref. No.	Qty.	Part #	Description
1	1	61-6209	Weldment, Baseplate, BX3824
2	4	61-5208	Weldment, 3/8-16 Nutplate, w/ 14" Wire
3	1	101-6885	Plate, Support, DS, BX3824
4	1	101-6886	Plate, Support, PS, BX3824
5	10	201-0368	3/8-16 X 1 1/4" Hex Bolt, Grd. 5, ZP
6	10	203-0010	3/8" Lock Washer, ZP
7	6	202-0003	3/8-16 Hex Nut, ZP
8	6	201-0446	8MM-1.25 x 30MM Hex Bolt, Grd. 8.8, ZP
9	6	203-0002	5/16" Lock Washer, ZP
10	6	203-0009	5/16" Flat Washer, ZP
11	2	201-0553	1/4-20 x 1/2" Hx. Wshd, Type F Screw
12	2	201-0192	#10-32 x 1/2" Slot Rd. Hd. Screw
13	2	203-0054	#10 Lock Washer
14	2	202-0047	#10-32 Hex Nut
15	2	101-5822	Adapter, 4 Way Connector
16	2	62-3468	Attachment. Assembly, SF/SB (R)
17	2	102-6730	Spacer Bracket, BX3824
18	2	201-0071	1/4-20 x 1 Hex Bolt, Grd. 5, ZP
19	4	203-0001	1/4" Flat Washer, ZP
20	2	203-0008	1/4" Lock Washer, ZP
21	2	202-0001	1/4-20 Hex Nut, ZP
22	2	201-0654	#10-16 x 1" Self Drilling Screw, ZP
	2	226-0046	Baseplate Safety Cable, 36" CL III (Not Shown)
	4	229-0359	Quicklink, 3/8, ZP (Not Shown)
	2	290-0437	Cap Plug, Black (Not Shown)

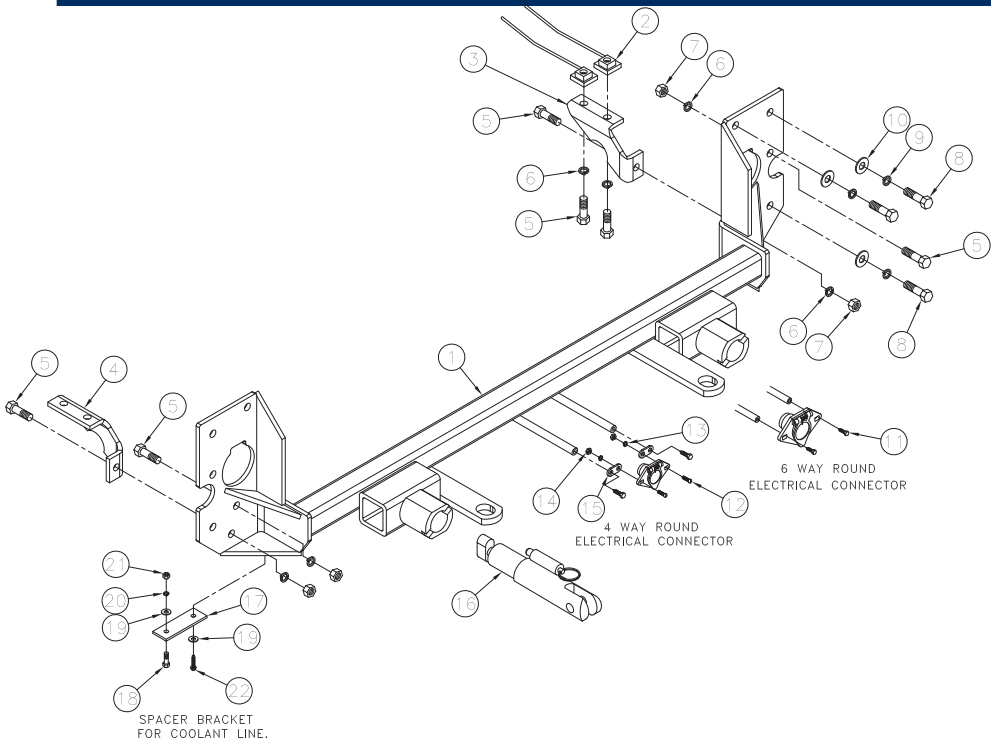

- ### Tools Required
- 10MM Socket
  - 13MM Socket
  - 18MM Socket & Wrench
  - T25 Torx Socket
  - T30 Torx Socket
  - 9/16" Socket
  - Long Flat Screwdriver
  - Small Flat Screwdriver
  - Reciprocating Saw
  - Diagonal Cutters
  - Utility Knife
  - Hammer
  - Flat Cold Chisel
  - LOCTITE Red
  - Self Tapping Drill

### Important:

Use only genuine factory replacement parts on your baseplate. Do **NOT** substitute homemade or non-typical parts. If a bolt is lost or in need of replacement, for your safety and the preservation of your baseplate, be sure to use a replacement bolt of the same grade (In most cases it will be Grade 5, please reference the parts list above). Replacement parts may be ordered through your nearest Blue Ox® Dealer or Distributor, or call our Customer Care Team at (402)385-3051. Failing to follow and/or altering these installation instructions in either installation or required equipment will void the manufacturer's warranty. Towing behind a non-motorized vehicle will void the warranty.

# BX3824

## 2006-09 VW Beetle

### Installation Instructions

#### Attachment Tabs:

Motorhome mount tow bars are recommended for use with this baseplate. Due to the design of the removable tabs, the RangeFinder II, Adventurer and Ambassador tow bars can not be used. The Acclaim tow bar may be used, but will not fold and store on the front of the vehicle. Adapters, except for the BX8833 and the BX88151, can not be used with this baseplate.

#### Instructions:

The front fascia, headlight assemblies, hood latch, horn bracket, turbo cooler, air dam, and metal bumper, are removed and reinstalled. Trimming of belly pan and front grille style is required.

The dimensional variations between otherwise identical vehicles can be considerable. While the baseplate was designed for easy installation, it may be necessary to tailor the baseplate slightly to compensate for auto manufacturer's tolerances. These minor adjustments may include filing a hole slightly, bending electrical rods or bending end plates.

The Bx8848 4 Diode Wiring Kit is recommended for this vehicle.

Handling of some cosmetic parts when installing this product may require the use of protective covers, rags, specialty tools, etc. to prevent damage.

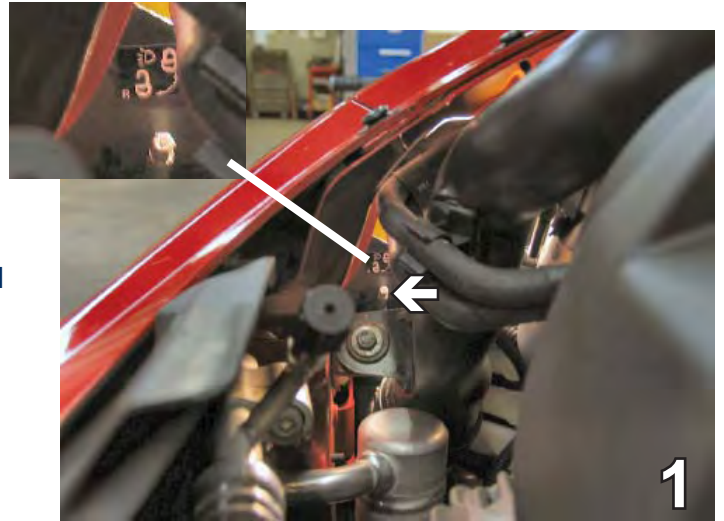

1. Locate a hex-head pin on the passenger's side, above the bottom of the headlight housing. Near it is a decal with a lock/unlock symbol. Loosen (unlock) the pin by rotating it clockwise. Pull the headlight assembly forward slightly. Do this to both sides of the vehicle.



2. On the driver's side, push down on a silver clip found behind the battery box and headlight housing. It can only be reached from above, so a long tool such as a screwdriver is needed to reach it. With the clip pressed down, pull headlight assembly forward to remove. A firm tug may be needed to release the headlight assembly from the electrical plug (see the white arrow in the photo above). Do this to both sides of the vehicle. Set headlight assemblies aside to reinstall later.  
**NOTE:** On the passenger's side, the silver clip is seen when looking down and between the windshield washer reservoirs fill tube and the vacuum baffle.



# BX3824

## 2006-09 VW Beetle

### Installation Instructions



3. Start the removal of the hood release by moving its clip upward. The hood release will move slightly up. A cloth placed under the screwdriver may reduce contact with painted surface and protect the finish.



4. Insert and twist a flat screwdriver to separate the hood release handle from the pins securing it.



5. Move hood release handle upwards and carefully guide the hood release out. Pay special attention to not allow the clip to fall out while guiding the hood release out. Set hood release handle aside to reinstall later.



6. Using a T30 Torx socket, remove four metric bolts from the top side of the fascia. Set bolts aside to reinstall later.

# BX3824

## 2006-09 VW Beetle

### Installation Instructions

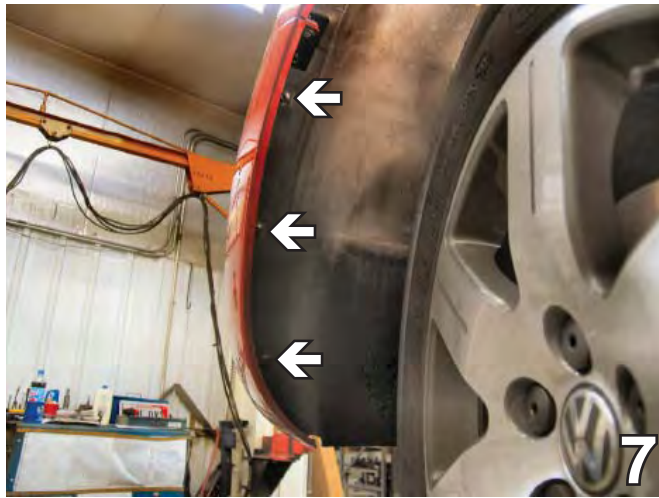

7. Inside the wheel well, just forward of the front tire, use a 25 Torx socket to remove three screws. Set screws aside to reinstall later. Do this to both sides of the vehicle.



8. Use a small flat screwdriver to remove three pushpins on the lower side of the fascia. See next step for removal technique.



9. Using the small flat screwdriver, push up on the center of pushpin. The pushpin is released. Do **NOT** push center push pin all the way through the base. Pry the pushpin out with the screwdriver. Set pushpins aside to reinstall later.

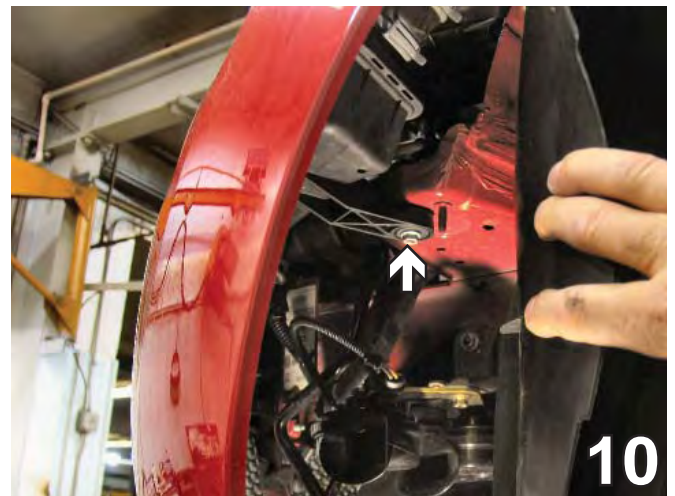

10. On the driver's side, pull the wheel well cover back. Use a 10MM socket to remove the hex nut from the air baffle. Pull down on the air baffle and swivel out of the way for easier access to the metric bolts to be removed later. This is only done to the driver's side. Set bolts aside to reinstall later.



BX3824  
2006-09 VW Beetle  
Installation Instructions

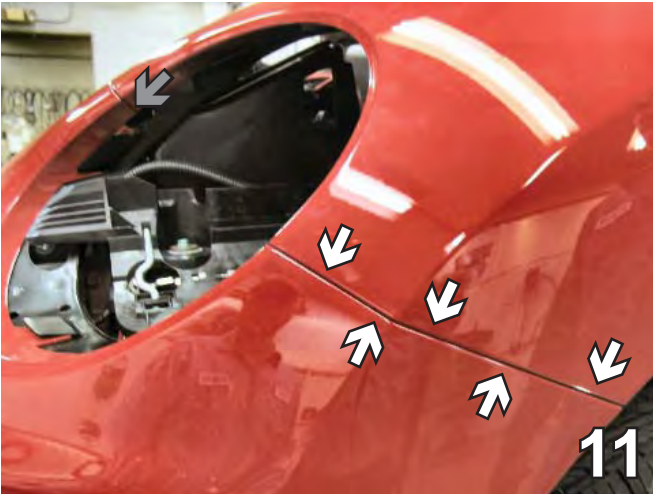

11. Using a T30 Torx socket, remove five metric bolts found in the area where the fascia and the front fender join, as indicated by the white arrows in the photo above. Two plates are also removed when the bolts are removed. Do this to both sides of the vehicle. Set bolts and plates aside to reinstall later.

**NOTE:** To prevent complications in fascia reinstallation, do not remove the plate and bolts found between the headlight and hood where the fascia and front fender join, as indicated by the grey arrow in the photo above.



12. Lift the fascia up, disconnect marker lights and temperature sensor (if the vehicle is equipped with such features). Use a 1" x 4" x 22" block of wood (not provided) as a brace to prop up the fascia. Remove the air dam shield immediately in front of the turbo cooler (if equipped on vehicle) simply by pulling it forward. Doing this releases it from two clips. Set air dam shield aside to reinstall later.



13. Remove the metric hex nut on the bottom of the metal bumper, using the 18mm socket and wrench, remove the metric bolt. Do this to both sides of the metal bumper. Remove metal bumper by pulling forward. Set bolts, hex nuts and bumper aside to be reinstalled later.

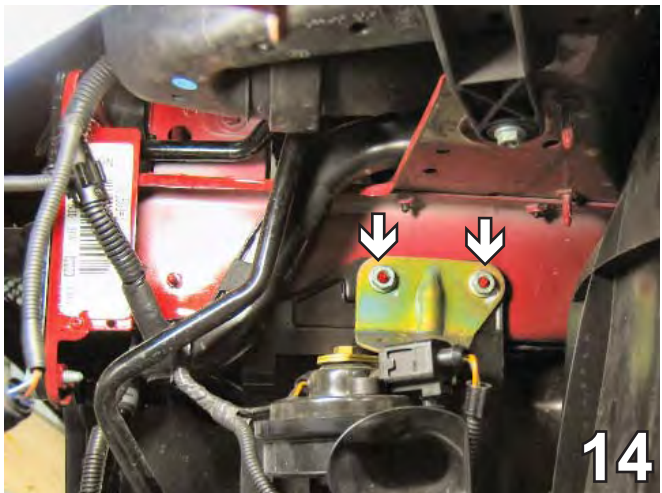

14. Using a 13mm socket, remove two hex nuts securing the horn bracket to the frame rail on the driver's side. Disconnect the horn. Set horn bracket and bolts aside to reinstall later.

# BX3824

## 2006-09 VW Beetle

### Installation Instructions

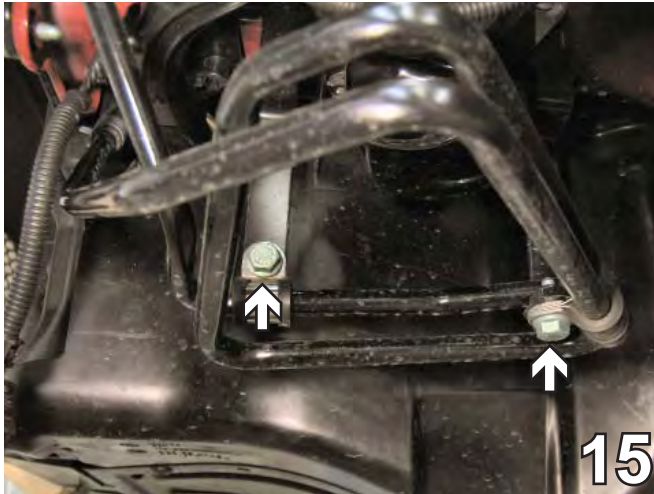

15. Just below the horn bracket, use a 13mm socket to remove two metric bolts securing a coil. Pull coolant coil down out of the way. Set bolts aside to reinstall later.



16. *Note: Only perform steps 16-18 for vehicles that have the type of coolant system shown in photos.* Using the 13mm socket, remove two metric bolts at each end of the coolant line. Set bolts aside to be reinstalled later. Move coolant line out of the way.



17. On the driver's side, disconnect the electrical connection to the coolant fan (see white arrow). Disconnect the two air lines (see grey arrows) by squeezing the sides of their lower ends to release clips.

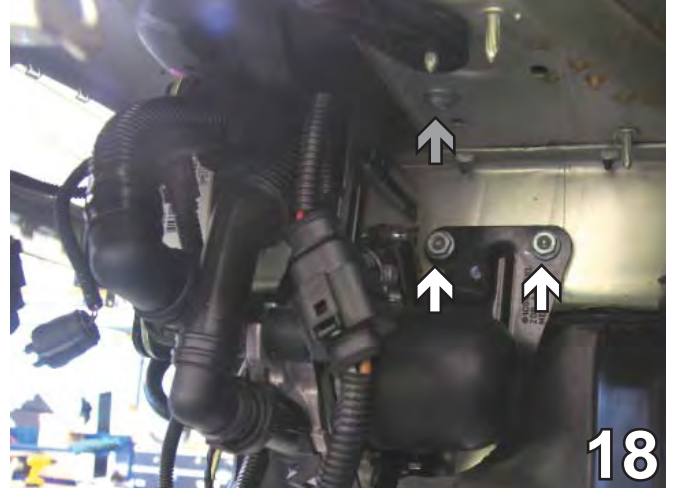

18. Using the 13mm socket, remove two metric bolts from the cooling system bracket (see white arrows). Using the 10mm socket, remove one metric bolt (that secures a support bar) from the frame extension (see grey arrow). Move coolant bracket and support bar out of the way. Do this to drivers side only.



# BX3824

## 2006-09 VW Beetle

### Installation Instructions



19. On the driver's side, pull down on the coax housing to separate it from the pin attached to the underside of the frame rail. Using a flat cold chisel, cut off the pin. This will prepare the area for installation of plate later.

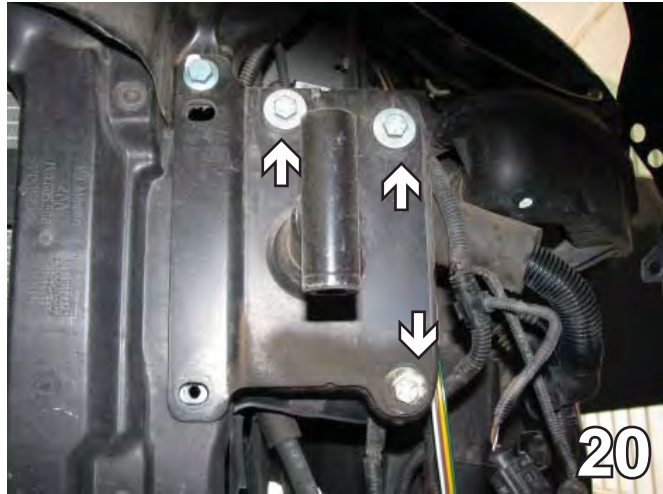

20. Using a 13MM socket, remove the three bolts from the bumper bracket on the driver's side. On the passenger side remove the top two bolts. There is no bolt in the bottom hole.

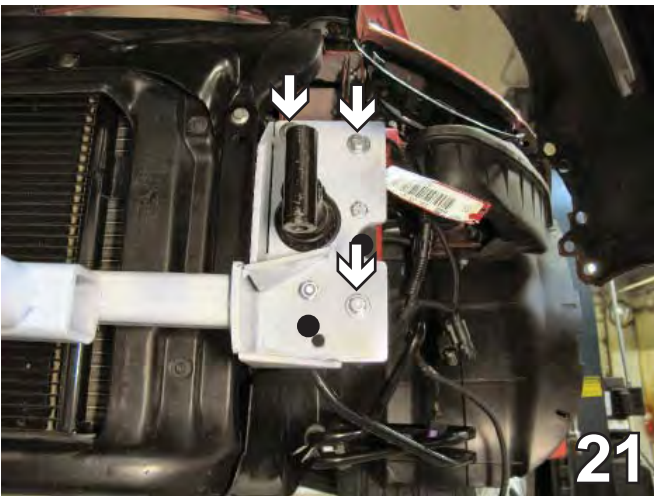

21. Slide the baseplate over and encircling the bumper bracket. Align the baseplate with the three existing holes of the bumper bracket (white arrows). Insert the 8MM-1.25 x 30MM hex bolts and fasten to the 5/16" lock washers and 5/16" flat washers to these bolt locations. Do this to both sides of the vehicle. Baseplate painted white to enhance visibility.



22. Using the baseplate as a template, drill two holes into the frame end using a 13/32" drill bit. From the backside of the baseplate, insert a 3/8-16 x 1 1/4" hex bolt and fasten to the 3/8" lock washer and 3/8-16 hex nut (grey arrow). From the front side of baseplate, insert a 3/8-16 x 1 1/4" hex bolt and fasten to the 3/8" lock washer and 3/8-16 hex nut (white arrow). Do this to both sides of the vehicle.

**Baseplate is painted white for illustrative purposes ONLY.**  
**The actual baseplate has a black powder coat finish.**

**When using power drills be aware of the dangers of torque and drill bit length.**

**\*\*BE SURE TO USE LOCTITE® RED ON ALL BOLTS BEFORE TIGHTENING. TIGHTEN ALL BOLTS ACCORDING TO THE TORQUE CHART ON PAGE 1 OF THESE INSTRUCTIONS OR ON PAGE 3 OF THE BASEPLATE TOWING GENERAL INSTRUCTIONS.**



# BX3824

## 2006-09 VW Beetle

### Installation Instructions



23. Place one end of the spacer bracket underneath the baseplate endplate with the other end facing the radiator. Use the bracket as a template to drill into endplate with a self tapping drill. Insert self drilling screw (see grey arrow) and 1/4" flat washer to drilled hole. Align coolant line bracket hole with spacer bracket hole (see white arrow). Insert 1/4-20 x 1 hex bolt through both holes and fasten to the 1/4" flat washer, 1/4" lock washer, and 1/4-20 hex nut. Do this to both sides of the vehicle.

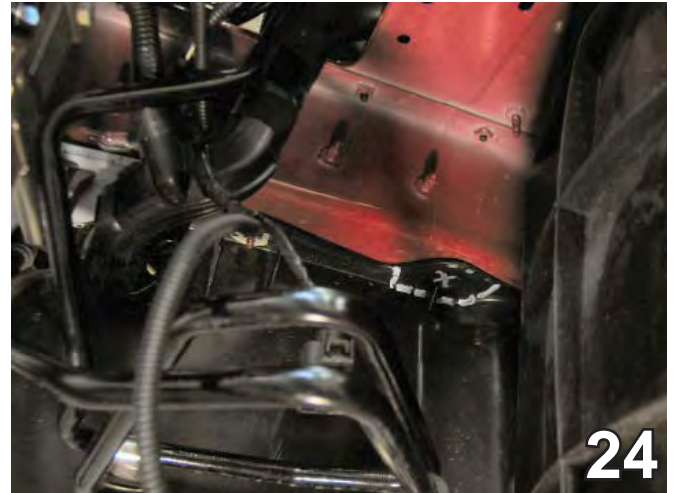

24. On the driver's side, underneath the frame, mark and trim a large enough area to gain access to a hole in the bottom frame that will be used for inserting nut plates later. Do this to both sides of the vehicle. Driver's side is shown. If the vehicle is equipped with a turbo cooler (on the passenger's side), find a dimpled section of plastic to mark and trim around - found between the turbo cooler and the frame, in the same location on the driver's side.



25. On the driver's side, mark and trim an area just below the wiring harness. Doing this allows the wiring harness to be moved while drilling. Avoid cutting the wire harness when using the utility knife.

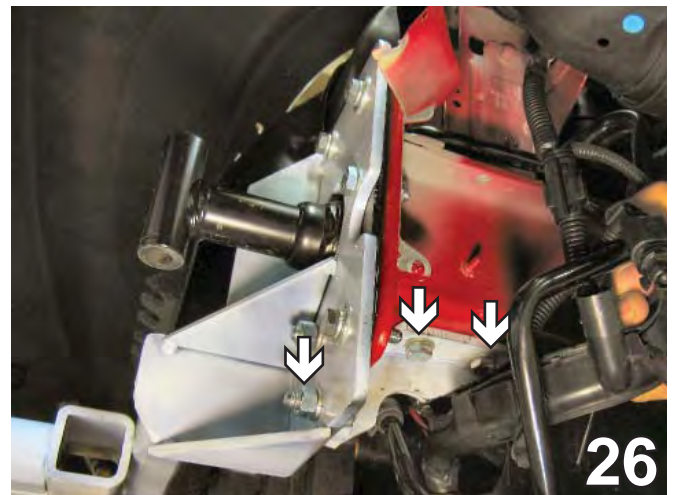

26. Take the appropriate driver's side or passenger's side support plate (see Parts List) and align with the lowest hole of baseplate, lower left arrow. The top side of support plate will rest against the frame's underside. Insert a 3/8-16 x 1 1/4 hex bolt through the support plate and into the lowest hole of baseplate and fasten to the 3/8" lock washer and 3/8-16 hex nut. Using the support plate as a template, drill two holes into the frame (see arrows)

with a 13/32" drill bit. Insert 3/8-16 nut plates into frame rail opening exposed with trimming earlier and align with the two drilled holes in frame. Insert 3/8-16 x 1 1/4 hex bolts and 3/8" lock washer into drilled holes and tighten. Do above steps to both sides of the vehicle. Support plate painted white to enhance visibility.

# BX3824

## 2006-09 VW Beetle

### Installation Instructions



27. Reinstall horn bracket and metal bumper.

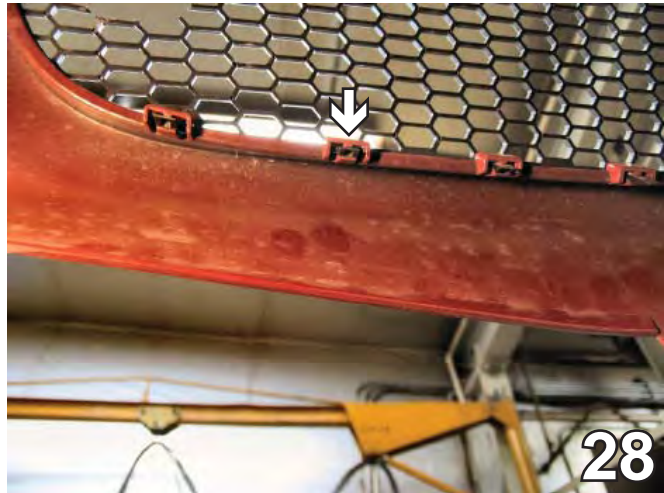

28. Remove the center grille by releasing the 15 clips the clips on the backside of the fascia. Eight on the top edge of the opening and seven on the bottom edge of the opening. The photo above shows several of the clips for illustration. Pull the center grille forward to remove and set aside to reinstall later.



29. Reinstall the fascia and center grille, inserting all screws, pushpins, and bolts. Align the fascia to its original position and, using a diagonal cutter, trim necessary openings in the grille for attachment tabs, convenience links, and electrical rods. The installation of the baseplate is complete.

Install the tow bar and safety cables according to the instructions when demonstrating this to the customer. Be sure to include all the contents and packages.

Do **NOT** substitute other devices if the tow bar pins and clips are misplaced.

**Be sure that ALL electrical connections are plugged in properly and functioning BEFORE installing the fascia.**

**DEALER or INSTALLER:**  
**Be certain the user receives the instruction sheets for their products.**



# BX3824

## 2006-09 VW Beetle

### Installation Instructions



**Without removable tabs installed.**

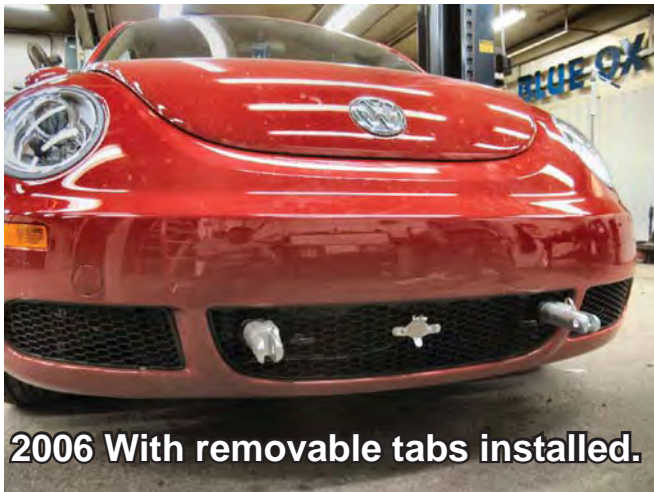

**2006 With removable tabs installed.**



**2008 With removable tabs installed.**

#### CUSTOMER SERVICE COMMITMENT

Blue Ox is committed to providing you with exceptional customer care throughout your lifetime with our products. Our team is here to assist you with any questions you may have regarding the performance of your product. Simply call 1-800-228-9289 and you can speak with our customer care team.

Additionally, please visit our website to see which rallies our Destination America team will be attending. For a nominal fee, our service technician will service your towing system to ensure it's in proper working condition. Also as a commitment to our customers, should you visit our factory you can stay at our full service Blue Ox campground at no charge along with enjoying a factory tour.

Again thank you for being our customer and for the confidence you have shown in the performance of our products. It is because of customers like you we enjoy the success we have today.

If the baseplate is in an accident, it must be replaced. **DO NOT** use it again! An accident can cause unseen damage and using it again could result in more damage or serious injury. **DO NOT** use the baseplate if it is damaged or missing parts.



© 2005, 06, 07, 08, 09, 10 Blue Ox  
One Mill Road, Industrial Park  
Pender, Nebraska 68047  
Phone: (402) 385-3051  
Toll Free: (888) 425-5382  
Fax: (402) 385-3360  
[www.blueox.com](http://www.blueox.com)