



BX3834

2012 VW Beetle Turbo Installation Instructions

Serial Number

Attachment Tab Height: 13-1/2"

Attachment Tab Width: 24"

Please read BOTH these Installation Instructions and the General Instructions prior to installing or operating this equipment.

- Blue Ox® towing products and accessories are intended to be installed by Blue Ox® Dealers who are familiar with our products and have the equipment and knowledge necessary to do "fit work". If needed, Blue Ox® Dealers can be found at www.blueox.com or by contacting our Customer Care Department at (402) 385-3051.
- Many Blue Ox® baseplates are designed to use existing holes and hardware to mount the baseplate to the towed vehicle. Even though bolts are there, do not assume they are adequate for baseplate mounting. Always use the hardware supplied in the hardware kit and existing hardware as specified in the installation instructions.

Bolt Torque Specifications
Torque in Foot-Pounds for Metric Bolts

| Bolt Size | Grade 8.8 | Grade 10.9 |
|-----------|-----------|------------|
| 6MM | 6 | 8 |
| 8MM | 16 | 22 |
| 10MM | 31 | 40 |
| 12MM | 54 | 70 |
| 14MM | 89 | 117 |

Bolt Torque Specifications
Torque in Foot-Pounds for Inch Bolts

| Bolt Size | Grade 5 | Grade 8 |
|-----------|---------|---------|
| 1/4" | 10 | 14 |
| 5/16" | 19 | 29 |
| 3/8" | 33 | 47 |
| 7/16" | 54 | 78 |
| 1/2" | 78 | 119 |
| 5/8" | 154 | 230 |



If the front of your vehicle looks different than this, please contact us at (402)385-3051.

Reference your vehicle owner's manual for manufacturer's towing specifications.

! WARNING

Failure to read and follow these instructions could result in separation of the towed vehicle from the tow bar, causing property damage, loss of towed vehicle, personal injury or death.

BX3834
2012 VW Beetle Turbo
Installation Instructions

Instruction Notes: The fascia is removed and reinstalled for the baseplate installation. Some drilling and trimming is required.

Place all components that are removed on a flat, sturdy surface. All items will be reinstalled unless otherwise noted after the baseplate is installed.

The dimensional variations between otherwise identical vehicles can be considerable. While the baseplate was designed for easy installation, it may be necessary to tailor the baseplate slightly to compensate for vehicle manufacturer's tolerances.

The BX8848 Tail Light Wiring Kit is recommended for this vehicle.

NOTICE

- Handling of some cosmetic parts when installing this product may require the use of protective covers, rags, specialty tools, etc. to prevent damage.
- When using power drills be aware of the dangers of torque and drill bit length.
- Be sure that **ALL** electrical connections are plugged in properly and functioning before reinstalling the fascia.
- Do not use the towed vehicle for storing luggage, equipment, etc. This may cause you to exceed the towing capacity of the tow bar, baseplate and its accessories.
- Be sure to use Loctite® Red on all bolts before tightening. Tighten all bolts according to the torque chart provided.

BX3834 2012 VW Beetle Turbo Installation Instructions

- Tools Required**
- Large Vise Grip
 - Flat Screwdriver
 - Utility Knife
 - Reciprocating Saw
 - Torque Wrench
 - Drill
 - Tape Measure
 - Loctite® RED
 - 13/32" Drill Bit
 - 1-1/4" Hole Saw
 - 13MM Socket
 - 9/16" Socket
 - T25 Torx
 - T50 Torx

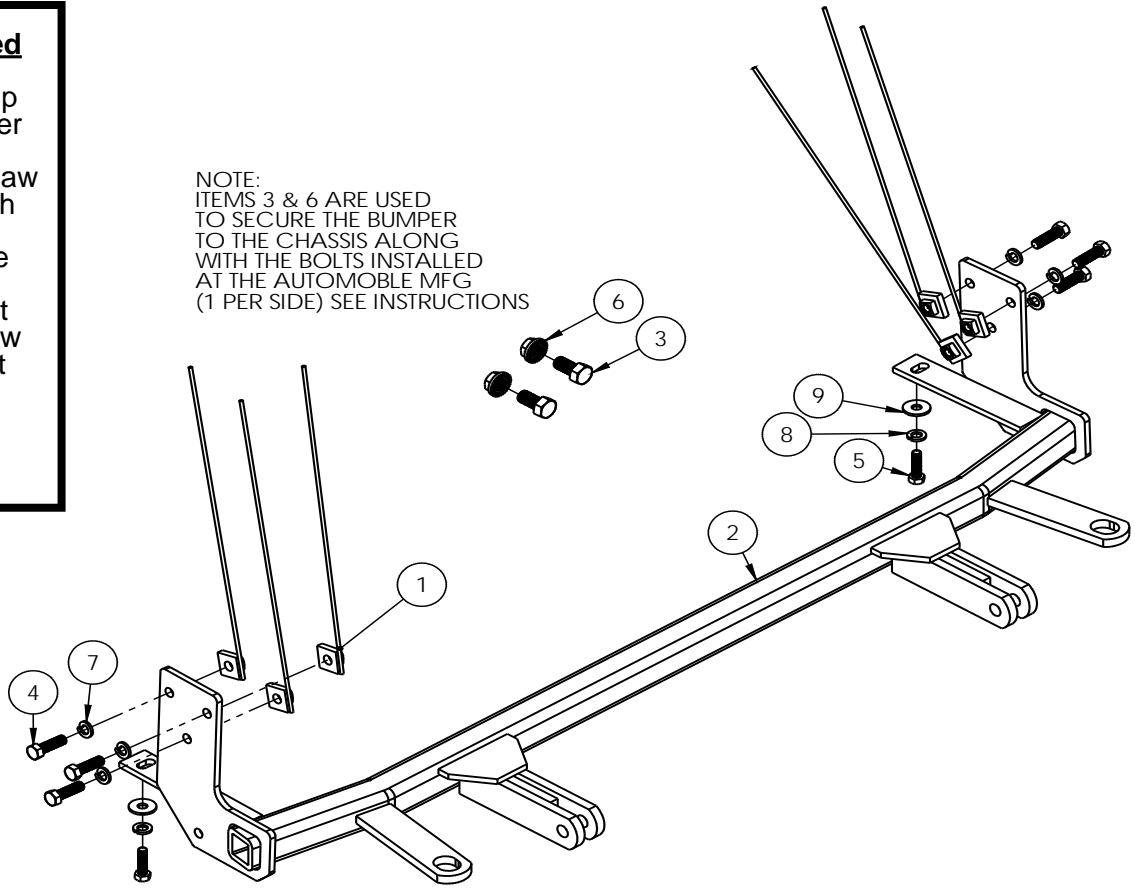

| Item No. | Part No. | Description | Qty. |
|----------|---------------------|---|------|
| 1 | 61-5208 | 3/8"-16 Nut Plate w/14" Wire | 6 |
| 2 | 61-7079 | BX3834 Baseplate | 1 |
| 3 | 201-0060 | 1/2"-13 x 1" Hex Bolt, Grade 5, ZP | 2 |
| 4 | 201-0368 | 3/8"-16 x 1-1/4" Hex Head Bolt, Grade 5, ZP | 6 |
| 5 | 201-0446 | 8MM-1.25 x 30MM Hex Bolt, Grade 8.8, ZP | 2 |
| 6 | 202-0072 | 1/2"-13 Hex Flange Whiz Lock Nut, ZP | 2 |
| 7 | 203-0010 | 3/8" Lock Washer, ZP | 6 |
| 8 | 203-0102 | 8MM Lock Washer, ZP | 2 |
| 9 | 203-0107 | 8MM Flat Washer, ZP | 2 |
| 10 | 226-0046(not shown) | Class III Safety Cables | 2 |
| 11 | 229-0359(not shown) | 3/8" Quicklink, ZP | 2 |

BX3834
2012 VW Beetle Turbo
Installation Instructions



1. Remove the four (4) push pins from the top edge of the radiator cover. There are two (2) on each side. Then remove cover from vehicle.

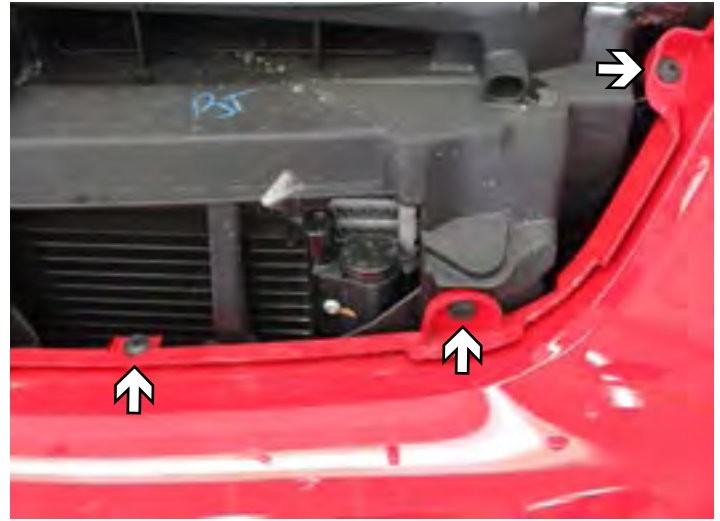

2. Using a 25 Torx, remove the six (6) screws at the top of the fascia. There are three (3) on each side.



3. In the wheel well, use a T25 Torx to remove the three (3) screws. Do this to both sides of the vehicle.



4. Behind the wheel well cover remove the one (1) upper fascia screw with a 25 Torx. Do this to both sides of the vehicle.

BX3834
2012 VW Beetle Turbo
Installation Instructions

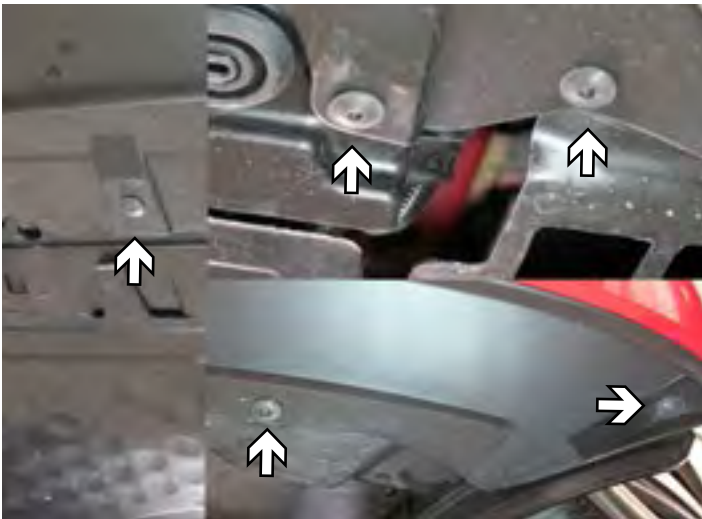

5. Using a 25 Torx remove the ten (10) screws from the underside of the fascia. There are five (5) on each side.



6. When removing front fascia, pull straight out and unhook both the side marker and running light wiring on both sides of vehicle.



7. After front fascia is removed, locate and remove the two (2) plastic shrouds at the front of vehicle on both sides. These will not be used during re-installation of front fascia.

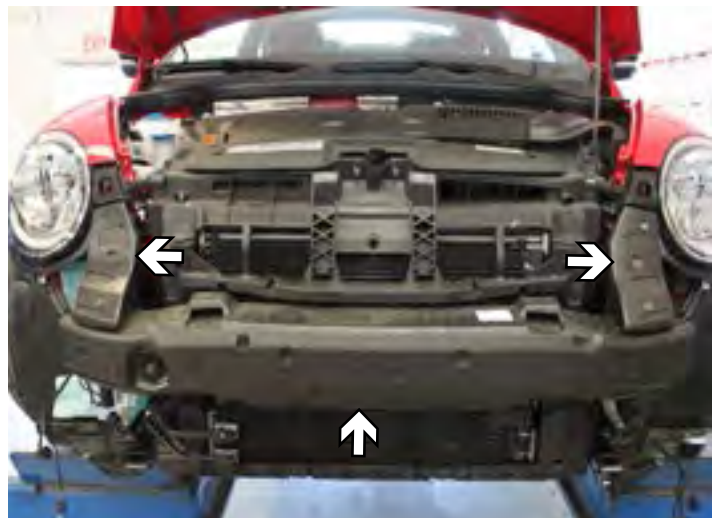

8. Remove the three (3) foam fascia support pieces. DO NOT discard these will be reinstalled.

BX3834
2012 VW Beetle Turbo
Installation Instructions

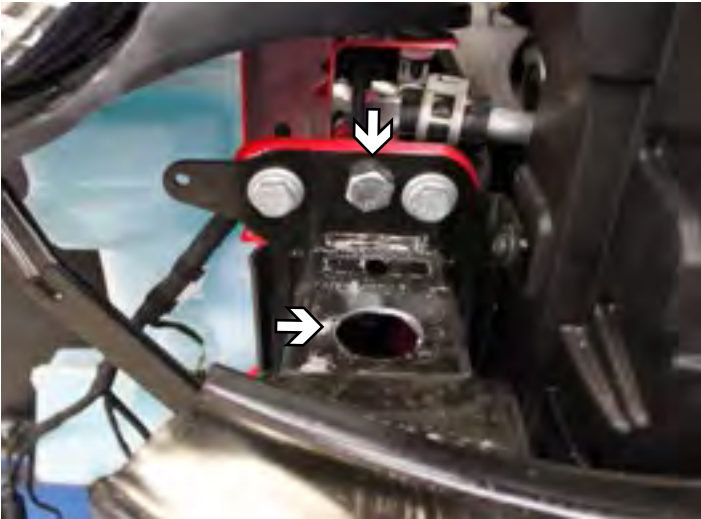

9. Install a 1/2"-13 x 1-1/2" bolt and 1/2"-13 whiz lock nut in the existing frame hole. Using a 1-1/4" hole saw bit drill a hole in this approximate location to be used later for baseplate installation. Repeat on other side of vehicle.



10. Using a 50 Torx, remove the one (1) screw at the top of the horn bracket, unhook the wiring and set aside. Repeat on other side.



11. Remove the tab the horn was attached to flush with the body, either by bending back and forth with vise-grips as shown or using a reciprocating saw. Repeat on other side of vehicle. **WARNING:** If using a reciprocating saw be aware of the fluid reservoir on the passenger side when cutting.



12. Rotate the baseplate from 90 degrees into place, attach at the bottom with a 8MM-1.25 x 30MM bolt, 8MM flat and lock washer. Level and clamp the baseplate. Drill the three (3) holes thru the frame using a 13/32" drill bit. Repeat on other side of vehicle.

BX3834
2012 VW Beetle Turbo
Installation Instructions

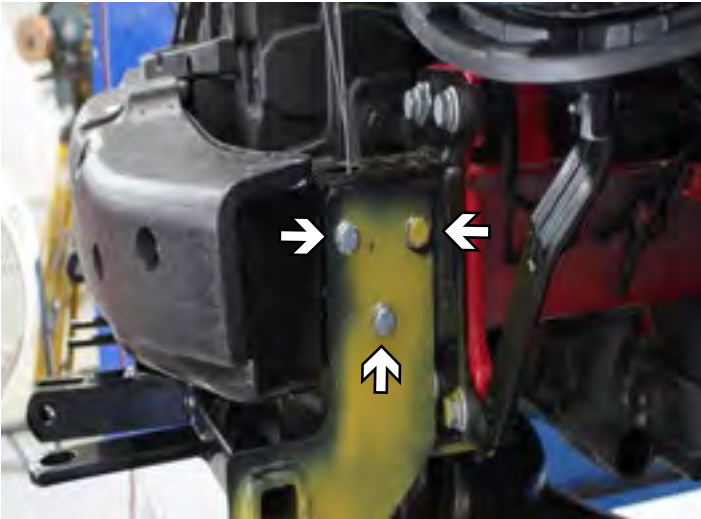

13. Install the three (3) 3/8"-16 x 1-1/4" bolts, 3/8" lock washers and 3/8"-16 nut plates w/wires using the 1-1/4" holes on top of frame to insert nuts. Repeat on other side of vehicle.

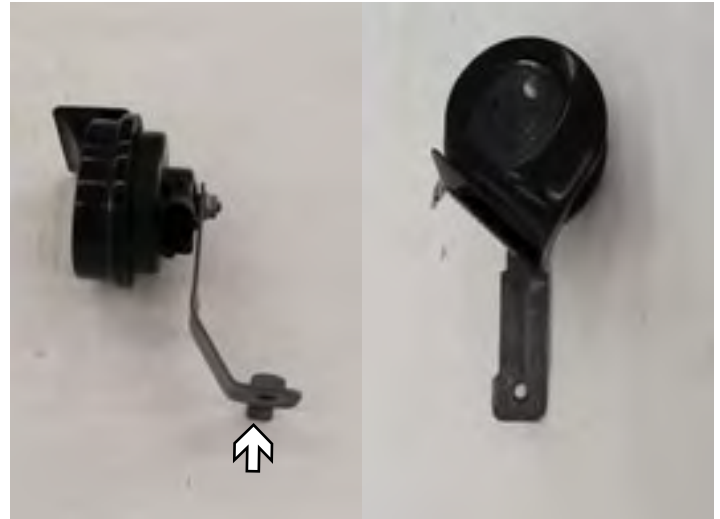

14. Flatten out the horn bracket with a hammer on a solid surface. Then remove the side tab with pliers or vise-grips by twisting back & forth (shown above to left). Bracket should look like right hand picture when done. Repeat on other horn.



15. Install the horn into the existing hole in baseplate using the original hardware. Adjust the bracket and horn if needed to fit. Repeat on other side of vehicle.

16. Attach the permanent baseplate safety cables to the provided convenience link on the baseplate. Additional options may interfere with suggested mounting; in this case, secure the cables to a solid piece of the frame as described in the instructions included with the permanent baseplate safety cables. Be sure the safety cables do not rub against any hoses or moving parts. Do this on **BOTH** sides of the vehicle.

17. Dealer or installer be certain the user receives the instruction sheet.

BX3834
2012 VW Beetle Turbo
Installation Instructions

CUSTOMER SERVICE COMMITMENT

Blue Ox® is committed to providing you with exceptional customer care throughout your lifetime with our products. Our team is here to assist you with any questions you may have regarding the performance of your product. Simply call (402) 385-3051 and you can speak with our customer care team.

Additionally, please visit our website to see which rallies our Destination America team will be attending. For a nominal fee, our service technician will service your towing system to ensure it's in proper working condition. Also, as a commitment to our customers, should you visit our factory, you can stay at our full service Blue Ox® campground at no charge along with enjoying a factory tour.

Again, thank you for being our customer and for the confidence you have shown in the performance of our products. It is because of customers like you we enjoy the success we have today.