

# 07-CURRENT GMC/CHEVY EXTENDED CAB IN320 03/15/07

TOOLS REQUIRED: 5/16" DRILL \* 1/2" HEX SOCKET \* 1/2" WRENCH \* 5/16" NUT DRIVER \* 3/8" NUT DRIVER

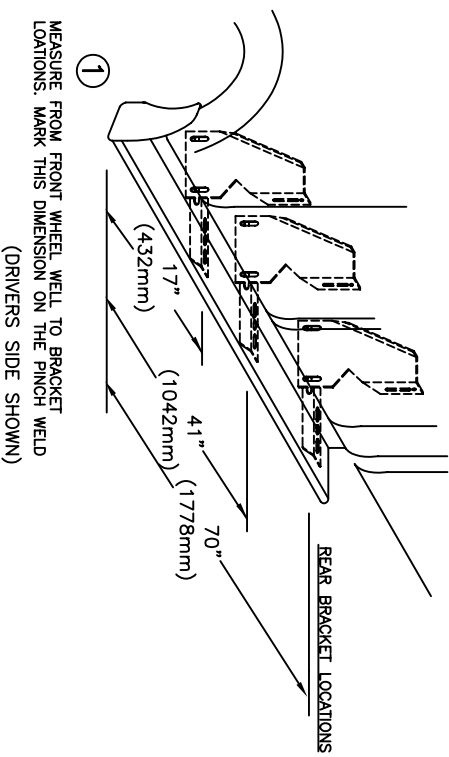

2 BRACKET ASSEMBLY ASSEMBLE WITH 5/16" BOLTS

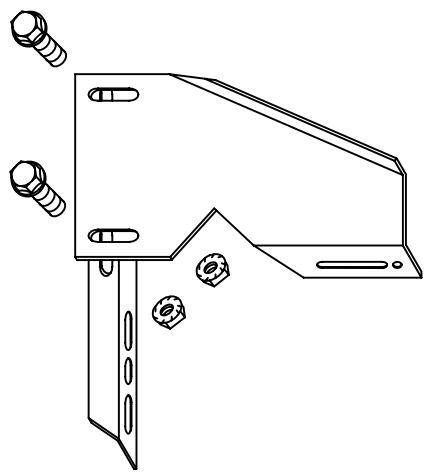

3 REMOVE RUBBER PLUGS FROM UNDERBODY AT MEASURED LOCATIONS AND INSTALL CLIP NUTS

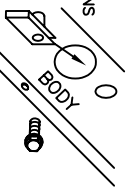

4 SLIDE CLIP NUT INTO BODY HOLES AT BRACKET LOCATIONS

BRACKET ASSEMBLY MOUNT TO BODY: ASSEMBLE WITH 5/16" BOLTS AND NUTS THROUGH FACTORY PINCH WELD HOLES AND INSTALLED CLIP NUTS

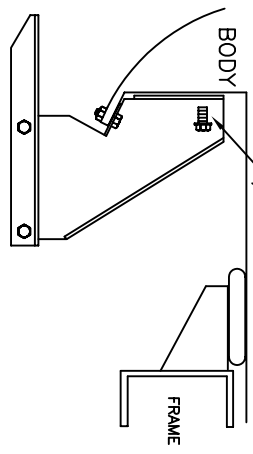

MOUNT AT LOCATIONS SHOWN AT 1

5 BEND STONE GUARD BY HAND AND KNEE TO FIT THE WHEEL WELL BEFORE INSTALLING TO RUNNING BOARD

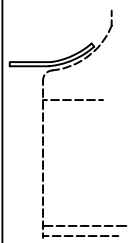

6 FASTEN FRONT STONE GUARD TO BOARDS WITH 3/8" SELF TAPPING BOLT. BEND STONE GUARD BY HAND AND KNEE TO FIT THE WHEEL WELL

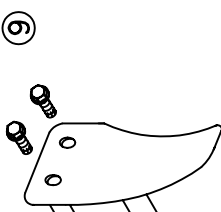

8 INSTALL END CAP TO BOARD WITH 3/8" SELF TAPPING BOLT

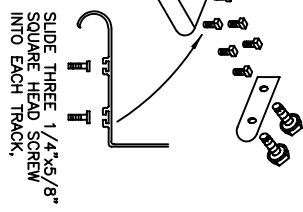

9 HOLD BOARD IN PLACE WITH THE REAR RESTING ON THE BACK BRACKET NOTE: BE SURE THAT 1/4" BOLTS ARE PLACED INTO THE BRACKET STEP SUPPORT

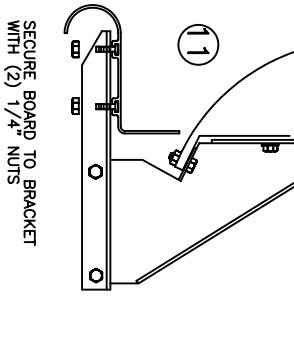
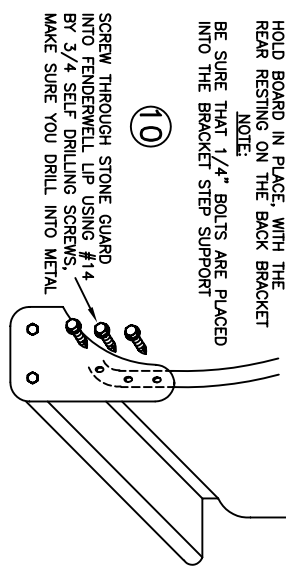

3 PLACES AT EACH STONE GUARD

12 WITH BOARD LEVEL TIGHTEN ALL LOOSE BOLTS

13 REPEAT FOR OTHER SIDE

INSTALLATION PARTS LIST:

QTY.	DESCRIPTION	QTY.	DESCRIPTION
2	RUNNING BOARD 1 DRIVER & 1 PASSENGER	2	END CAP 1 LEFT & 1 RIGHT
2	STONE GUARD 1 LEFT & 1 RIGHT	24	5/16" x 3/4" WASHER HEAD BOLT
8	3/8" x 1 SELF TAPPING SCREW	18	5/16-18 HEX WASHER HEAD NUT
6	#14x3/4" TEK SCREW	6	FLAT BRACKET, FLO7
12	1/4x5/8" SQUARE HEAD SCREW	6	HORIZONTAL BRACKET, SUPPORT, 3124F
12	1/4-20 HEX NUT	6	CLIP NUT

IN320 03/15/07  
 OWENS PRODUCTS, INC. \*1107 PROGRESS STREET\*STURGIS, MI 49091\*269-651-2300\*TOLL-FREE: 800-726-9367\*TX:269-651-9326\*WEB:WWW.OWENS-PRO.COM