

Installation Instructions

I - Sheet Number WV05 Rev.A



Ventvisor® Deflector

**For proper installation and best possible fit, please read all instructions BEFORE you begin.
For technical assistance or to obtain missing parts, please call Customer Relations at 1-800-241-7219.**

Important Safety Information



- CAUTION - Before driving, ensure that the vent visors are properly secured to vehicle.
- Do not use automatic "brush-style" car washes.
- Do not use cleaning solvents of any kind.
- Periodically check all components for tightness.
- When using Surface Prep, avoid contact with skin. Use in well ventilated area. If contact is made with material, flush area with large amounts of water. If irritation persists, get immediate medical attention. USE PREP ON RUBBER ONLY

Contents - 2 Piece Set

NOTE: Actual product may vary from illustration.

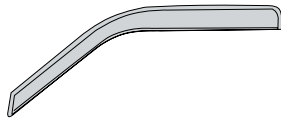

Front Driver Side Visor

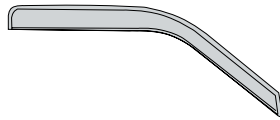

Front Passenger Side Visor



Alcohol Pad x2



Scotch Brite Pad



Surface Prep

Contents - 4 Piece Set

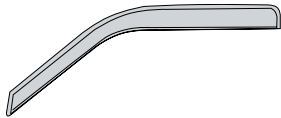

Front Driver Side Visor

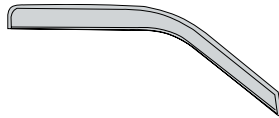

Front Passenger Side Visor



Rear Driver Side Visor



Rear Passenger Side Visor



Alcohol Pad x2



Scotch Brite Pad



Surface Prep

Tools Required



Car Wash Supplies



Clean Towel

Preparation Before Painting / Installation

- A trial fit is recommended to ensure proper positioning and fit.
- Check fit of parts before painting as we will not accept the return of modified or painted parts.
- Wash your vehicle to remove any debris and/or dirt.
- Dry with a clean towel.

Installation Steps

NOTE: Actual application may vary slightly from illustrations.



Scuff rubber trim where drivers side visor mounts with scotch brite pad. Then clean with alcohol pad. Repeat for all (4) doors.

Alcohol Pad

mirror cap

1

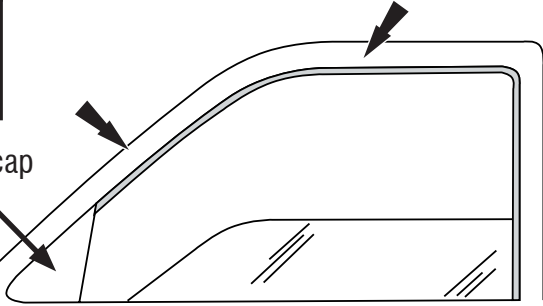

Apply one coat of surface prep to previously cleaned rubber trim on all (4) doors promptly to prevent evaporation.

2

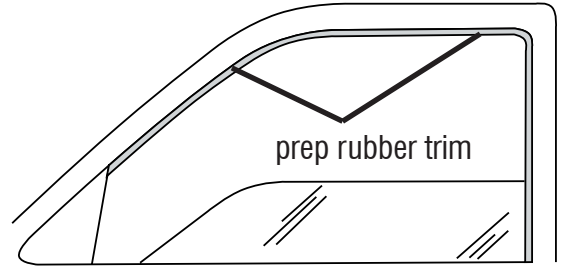

Peel back 2" (5cm) of tape liner from the front and rear flanges.

tape liner

rear end flange

tape liner

front end flange

3

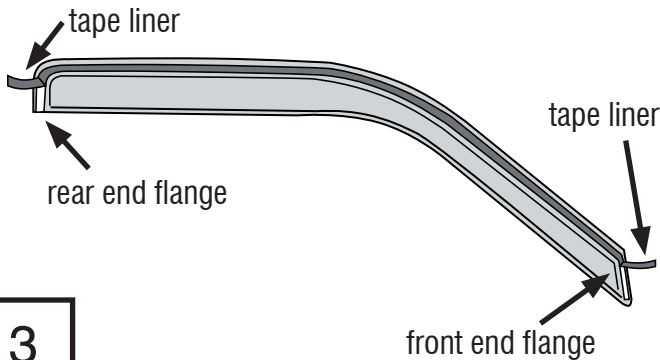

Align the drivers side visor with previously cleaned rubber trim. Slide the front end flange under the mirror cap. Press exposed area of tape.

free end

slide under mirror cap

free end

4

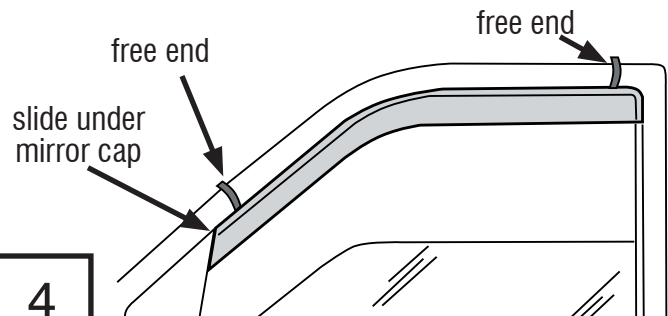

With the visor in its final position, remove the remainder of the tape liner by pulling on free ends.

5

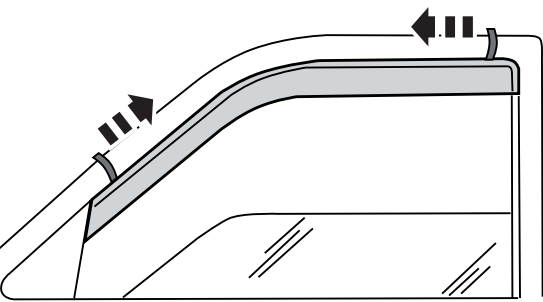

Apply pressure along flange edges to ensure proper adhesion.



6

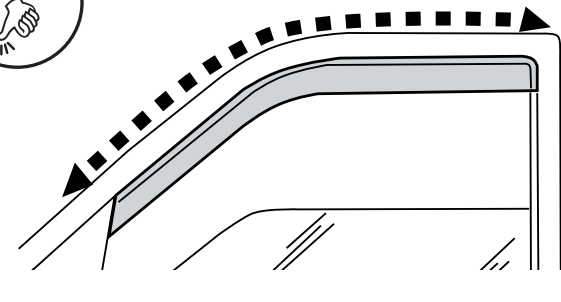

The drivers side rear visor attaches to the rubber trim utilizing the same procedure.

rear visor in final position

7

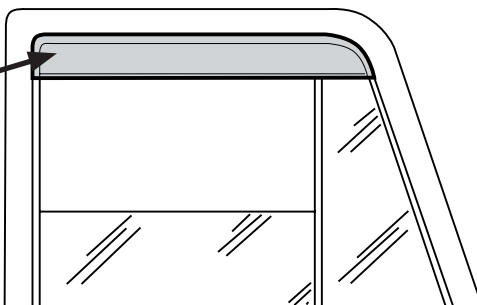

Repeat **Steps 1-7** for passenger side.

Care and Cleaning

- Wash only with mild soap & dry with a clean cloth.

Congratulations!

You have purchased one of the many quality Auto Ventshade™ branded products offered by Lund International, Inc. We take the utmost pride in our products and want you to enjoy years of satisfaction from your investment. We have made every effort to ensure that your product is top quality in terms of fit, durability, finish and ease of installation.



AUTO VENTSHADE™

Lund International, Ventshade Accessories Division

655 Raco Drive, Lawrenceville, GA 30045

800-241-7219 • Fax 770-339-5839 • Visit us at lundinternational.com



© 2004 Lund International, Inc. All rights reserved.

Auto Ventshade™, the Auto Ventshade™ logo and the AVS™ logo are trademarks of Lund International, Inc.





Défecteur Ventvisor®

Pour obtenir une installation correcte et le meilleur ajustement possible, lire toutes les instructions AVANT de commencer.

Pour toute assistance technique ou obtention de pièces manquantes, appeler le service des relations avec la clientèle au 1-800-241-7219.

Informations importantes concernant la sécurité



- ATTENTION – Avant de conduire, s'assurer que la visière est solidement assujettie sur le véhicule.
- Ne pas utiliser les stations de lavage de voitures à brosses.
- Ne pas utiliser de solvants.
- Vérifier régulièrement le serrage des composants.
- En utilisant la préparation extérieure, évitez le contact avec la peau. Employez dans le secteur bien aéré. Si le contact est fait avec le matériel, secteur affleurant avec de grandes quantités de l'eau. Si l'irritation persiste, obtenez une attention médicale immédiate. EMPLOYEZ LA PRÉPARATION SUR LE CAOUTCHOUC SEULEMENT.

Contenu - Ensemble 2 pièces

NOTE: Le produit réel peut changer de l'illustration.

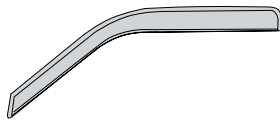

Visière avant
côté conducteur

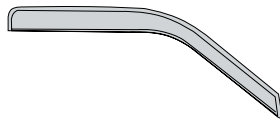

Visière avant
côté passager



Tampons à
l'alcool (2)

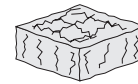

tampon à récurer
Scotch Briter

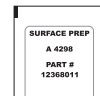

Préparation
Extérieure

Contenu - Ensemble 4 pièces

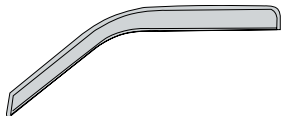

Visière avant
côté conducteur

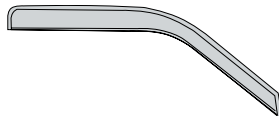

Visière avant
côté passager



Visière arrière
côté conducteur



Visière arrière
côté passager



Tampons à l'alcool (2)



tampon à récurer Scotch Briter



Préparation Extérieure

Outils nécessaires



Fournitures pour lavage de voiture



Serviette propre

Préparation pour la peinture/l'installation

- Il est recommandé de procéder à un essai pour s'assurer que le positionnement et l'ajustement sont corrects.
- Vérifier l'ajustement des pièces avant peinture, car nous n'acceptons pas le retour de pièces modifiées ou peintes.
- Lavez votre véhicule pour enlever n'importe quels débris et/ou saleté..
- Séchez avec une serviette propre.

Étapes d'installation

REMARQUE : La méthode d'application peut être légèrement différente de celle représentée par les illustrations.



Alcohol Pad

Frotter la garniture en caoutchouc, à l'emplacement de montage de la visière côté conducteur, avec le tampon à récurer Scotch Brite. Nettoyer ensuite avec le tampon à l'alcool. Répéter l'opération pour les (4) portières.

Couvercle du rétroviseur

1

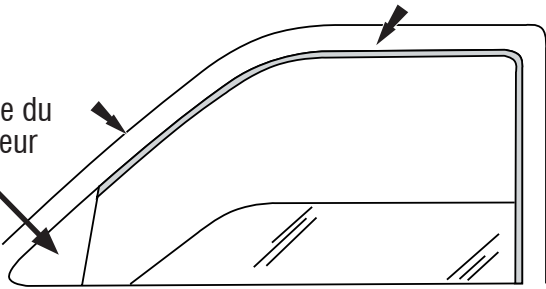

Enduire la garniture en caoutchouc précédemment nettoyée des (4) portières d'une couche de produit de préparation de la surface, sans délai afin de prévenir toute évaporation.

Enduire la garniture en caoutchouc de produit de préparation de la surface.

2

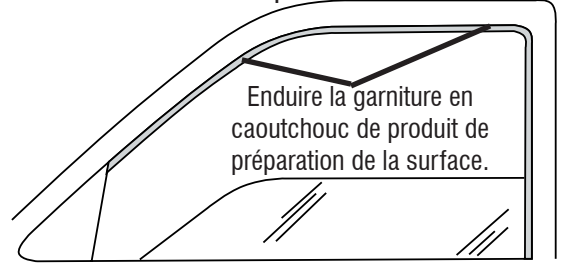

Découper 5cm (2 po) de protection d'adhésif des rebords avant et arrière.

Protection d'adhésif

Protection d'adhésif

Rebord d'extrémité arrière

Rebord d'extrémité avant

3

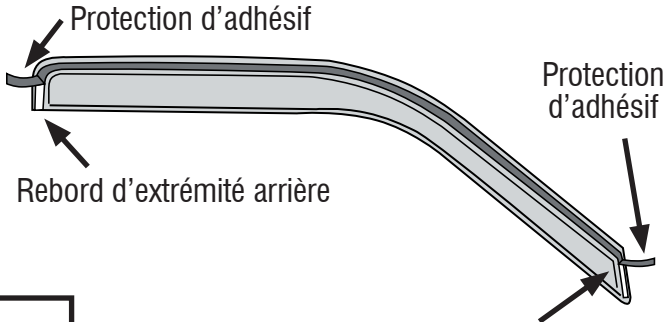

Aligner la visière côté conducteur et la garniture en caoutchouc précédemment nettoyée. Faire glisser le rebord de l'extrémité avant sous le couvercle du rétroviseur. Appuyer sur la partie exposée du ruban.

Extrémité libre

Extrémité libre

Faire glisser sous le couvercle du rétroviseur

4

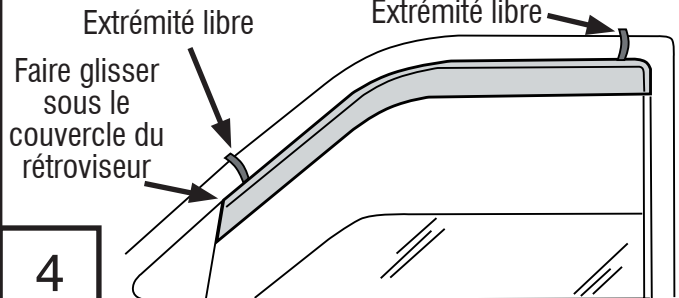

Une fois la visière en position finale, retirer le reste de la protection d'adhésif en tirant sur ses extrémités libres.

5

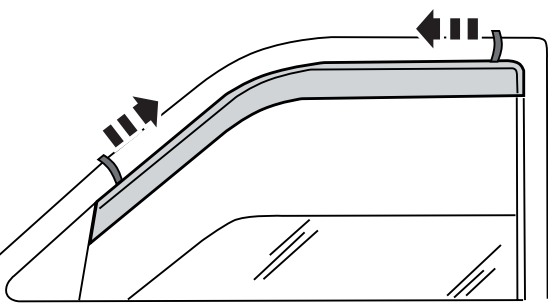

Appuyer tout le long des rebords pour assurer une bonne adhésion.



6

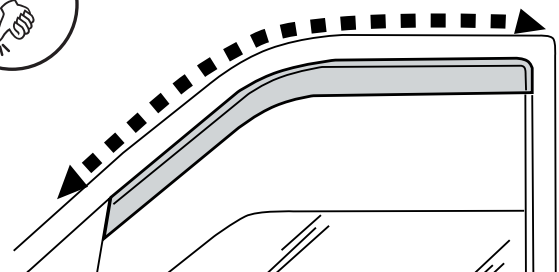

La visière arrière du côté conducteur se fixe à la garniture en caoutchouc suivant la même procédure.

Visière arrière en position finale

7

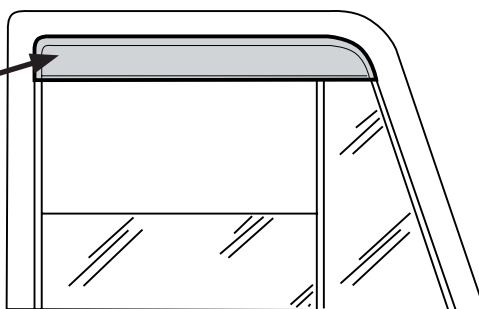

Répéter les étapes 1 à 7 du côté passager.

Entretien et nettoyage

- Laver exclusivement avec de l'eau savonneuse et sécher avec un chiffon propre.

Félicitations !

Vous avez acheté l'un des nombreux produits de qualité Auto Ventshade™ fabriqués par Lund International, Inc. Nous sommes extrêmement fiers de nos produits et souhaitons que vous tiriez des années de satisfaction de votre investissement. Nous avons pris toutes les mesures nécessaires pour assurer que ce produit est d'une qualité supérieure en ce qui concerne l'ajustement, la durabilité, la finition et la facilité d'installation.



AUTO VENTSHADE™

Lund International, Ventshade Accessories Division

655 Raco Drive, Lawrenceville, GA 30045, USA

800-241-7219 • Fax 770-339-5839 • Visitez notre site lundinternational.com



© 2005 Lund International, Inc. Tous droits réservés.

Auto Ventshade™, le logo Auto Ventshade™ et le logo AVS™ sont des marques déposées de Lund International, Inc.





Deflector Ventvisor®

Para una instalación adecuada y el mejor ajuste posible, lea todas las instrucciones ANTES de comenzar. Si desea recibir asistencia técnica u obtener piezas faltantes, llame al Servicio al cliente al 1-800-241-7219.

Información importante de seguridad



- **PRECAUCIÓN** - Antes de conducir, asegúrese de que la visera deflectora esté correctamente anclada al vehículo.
- No utilice servicios automáticos de limpieza de vehículos que utilizan cepillos.
- No utilice limpiadores al solvente de ningún tipo.
- Compruebe periódicamente que todos los componentes estén ajustados.
- Al usar la preparación superficial, evite el contacto con la piel. Utilice en área bien ventilada. Si el contacto se hace con el material, área rasante con cantidades grandes de agua. Si persiste la irritación, consiga la atención médica inmediata. **UTILICE LA PREPARACIÓN EN EL CAUCHO SOLAMENTE**

Contenido - Juego de dos piezas **NOTA:** El producto real puede variar de la ilustración.

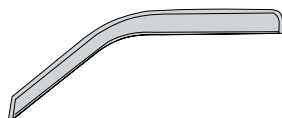

Visera del conductor

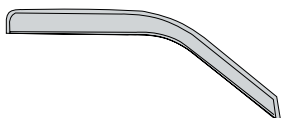

Visera del acompañante



Paño esterilizado (2)



el paño Scotch Brite



Preparación Superficial

Contenido - Juego de cuatro piezas

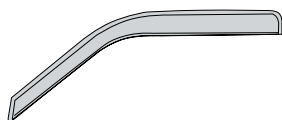

Visera del conductor

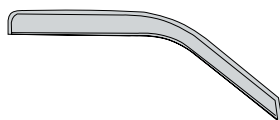

Visera del acompañante

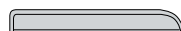

Visera trasera lateral izquierdo

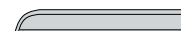

Visera trasera lateral derecho



Paño esterilizado (2)

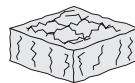

el paño Scotch Brite



Preparación Superficial

Herramientas necesarias



Equipo de limpieza de vehículos



Toalla limpia

Preparación antes de pintar o instalar

- Se recomienda realizar un ajuste de prueba para asegurar el posicionamiento y ajuste correctos.
- Compruebe que las piezas se ajusten correctamente antes de pintarlas, ya que no aceptaremos la devolución de piezas modificadas o pintadas.
- Lave su vehículo para quitar cualquier ruina y/o suciedad.
- Séchez avec une serviette propre.

Pasos de instalación

AVISO: La colocación real puede variar con respecto a las ilustraciones.



Pula la banda de goma donde se montan las viseras del conductor con el paño Scotch Brite. Luego limpie con un paño esterilizado. Repita para las (4) puertas.

Alcohol Pad

cubierta del espejo

1

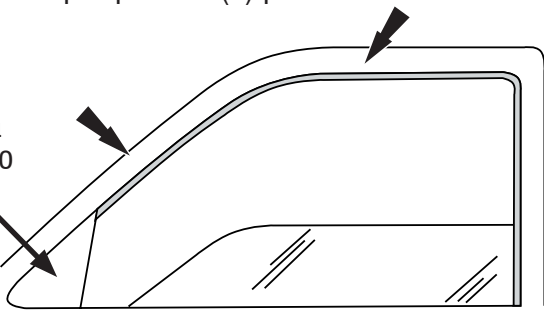

Aplique una capa de preparador de superficies a la banda de goma limpiada recientemente en las (4) puertas rápidamente para evitar la evaporación.

2



prepare la banda de goma

Retire 2" (5 cm) de cinta protectora de los rebordes traseros y delanteros.

cinta protectora

cinta protectora

reborde del extremo trasero

reborde del extremo delantero

3

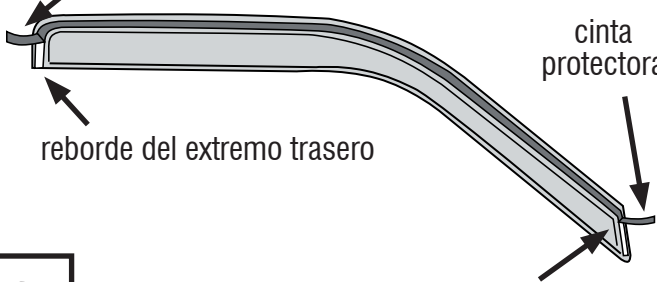

Alinee la visera del conductor con la banda de goma que limpió anteriormente. Deslice el reborde del extremo delantero bajo la cubierta del espejo. Presione la cinta expuesta.

extremo libre

extremo libre

deslice bajo la cubierta del espejo

4

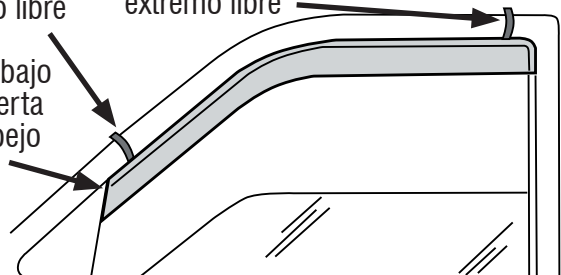

Con la visera en su posición definitiva, quite la cinta protectora restante tirando de los extremos que quedaron libres.

5

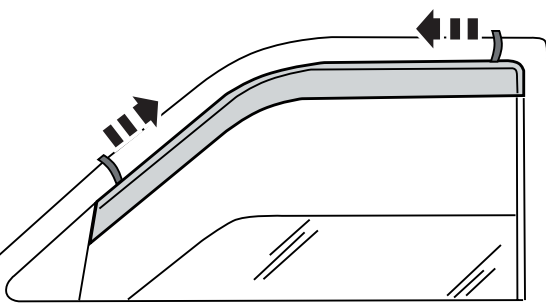

Presione sobre los bordes del reborde para asegurarse de que se adhiera adecuadamente.



6

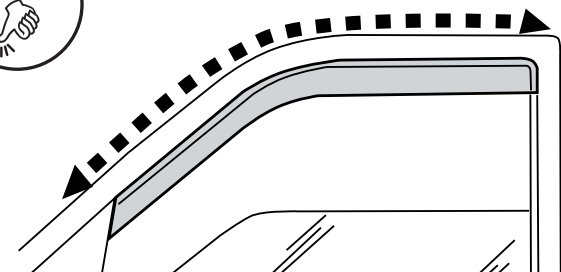

La visera trasera del conductor se adjunta a la banda de goma utilizando el mismo procedimiento.

visera trasera en posición definitiva

7

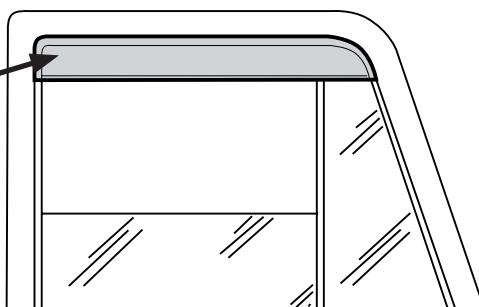

Repita los Pasos 1 a 7 para el lado del acompañante.

Cuidado y limpieza

- Limpie solamente con agua jabonosa tibia y seque con un paño limpio.

Felicidades

Usted ha comprado uno de los tantos artículos de calidad de Auto Ventshade™ ofrecidos por Lund International, Inc. Nuestros productos son nuestro mayor orgullo. Deseamos que disfrute de años de satisfacción con su inversión. Hemos realizado todos los esfuerzos para asegurarnos de que su producto sea de la mejor calidad en cuanto a ajuste, durabilidad, acabado y facilidad de instalación.



AUTO VENTSHADE™

Lund International, Ventshade Accessories Division

655 Raco Drive, Lawrenceville, GA 30045

800-241-7219 • Fax 770-339-5839 • Visite nuestro sitio Web: lundinternational.com



© 2005 Lund International, Inc. Todos los derechos reservados.

Auto Ventshade™, el logo de Auto Ventshade™ y el logo de AVS™ son marcas comerciales de Lund International, Inc.

