

#TL100044

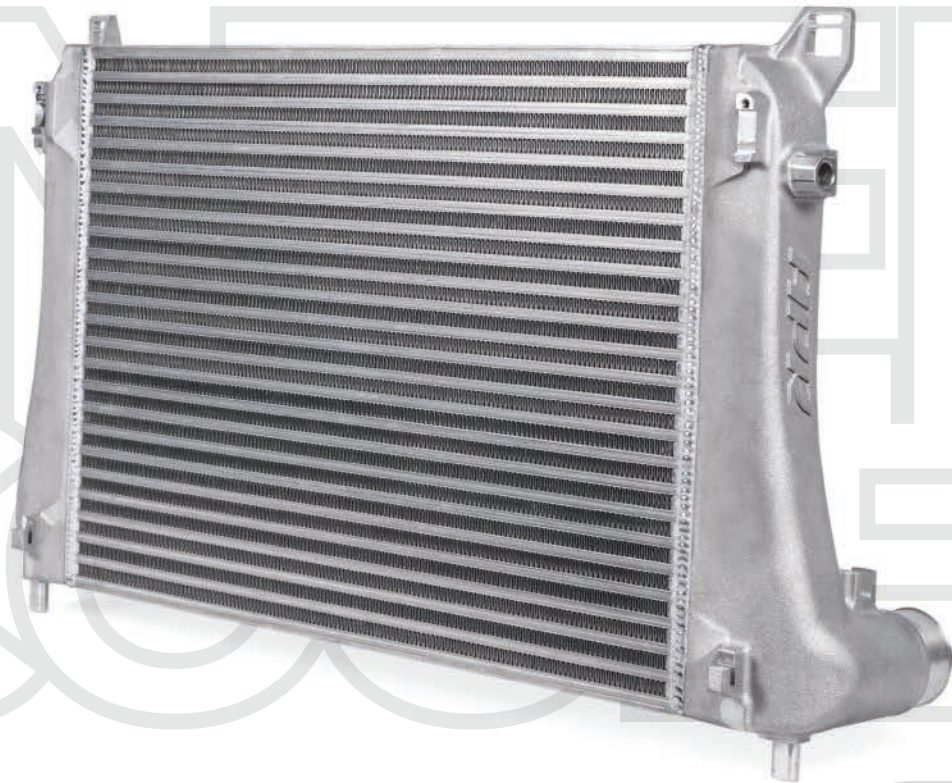

MQB 1.8T/2.0T INTERCOOLER/
INSTALLATION INSTRUCTIONS

APR

Notes:

These instructions were written for a North American specification MkVII Golf R. Other models, like the GTI, are similar.

When disassembling the car, be sure to keep all fasteners so they can be reused. It is recommend that you get some kind of compartmented tray to organize the fastners, such as a fishing tackle box or several large ice cube trays. Fasteners that are not reused for reinstallation are noted in the instructions. All directions used in this manual (right, left, front, etc.) are based on if you were sitting in the drivers seat of the car.

These instructions assume that you have basic mechanical skills and several varieties of the tools of basic hand tools in order to install the kit. If you have any questions about the install, feel free to contact your APR representative.



1) Securely lift vehicle. If a vehicle lift is not used, secure the vehicle with jack stands. It is not necessary to remove the wheels, but will make installation easier.

2) Remove the T25 screw that holds the intake to the back side of the core support.

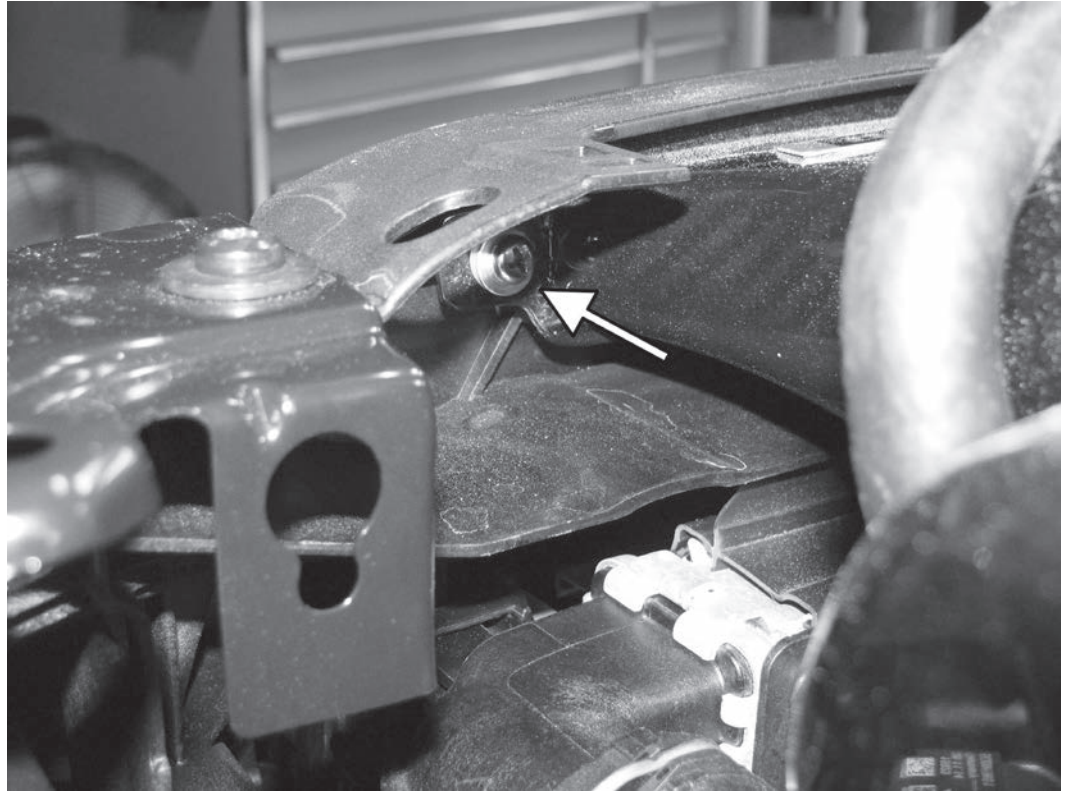

APR, LLC

4800 US HWY 280 West Opelika Alabama 36801

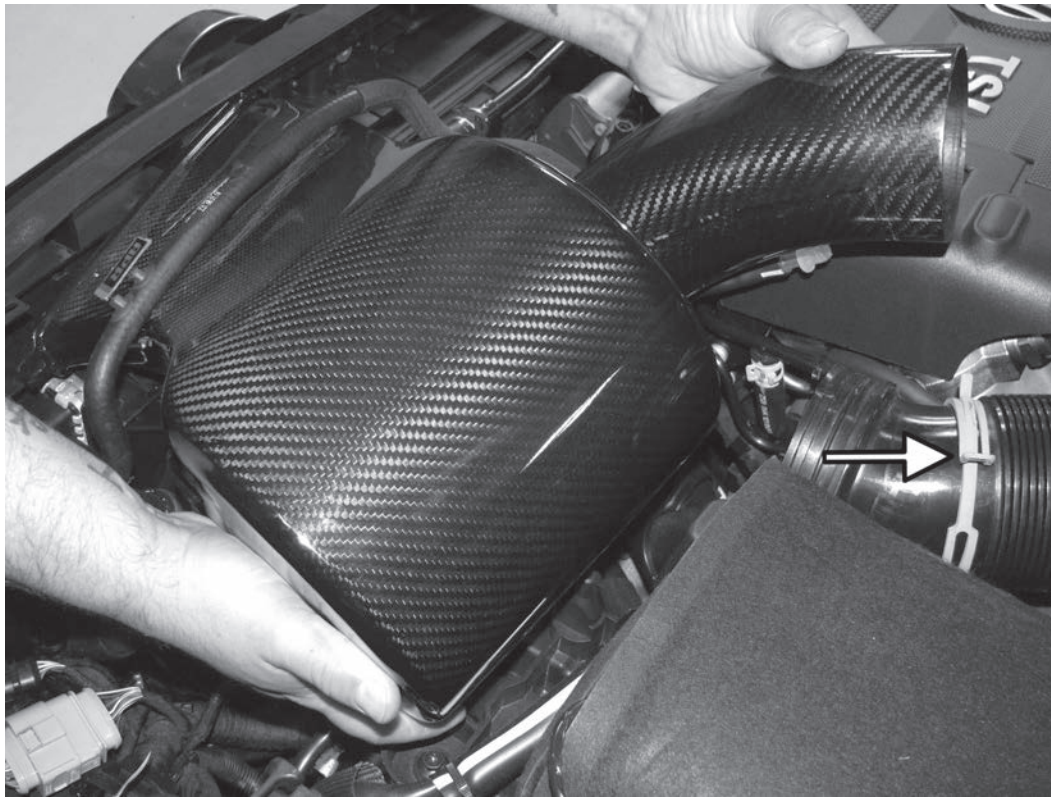

3) Remove the clamp from the backside of the intake. Rotate the intake to remove it from the mounting tab on the core support, and lift the intake up from the car. Be sure to disconnect the vacuum line from the bottom of the intake.

4) Remove the two T25 screws from the top of the front grill.

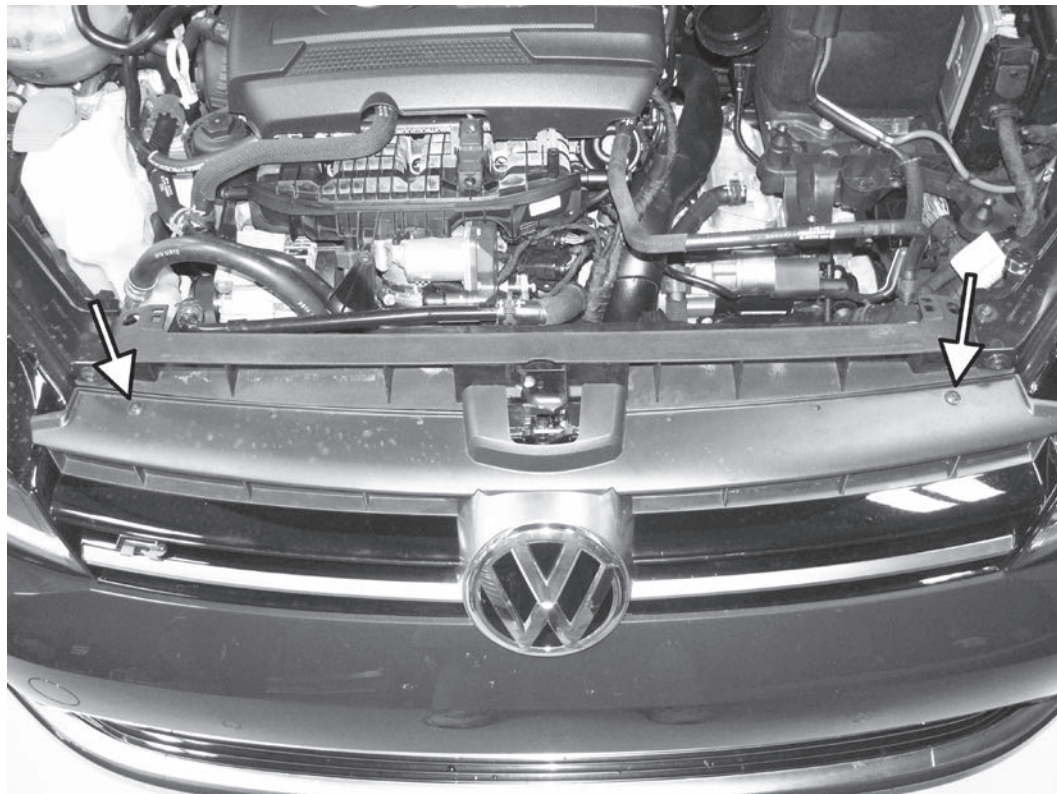

APR, LLC

4800 US HWY 280 West Opelika Alabama 36801

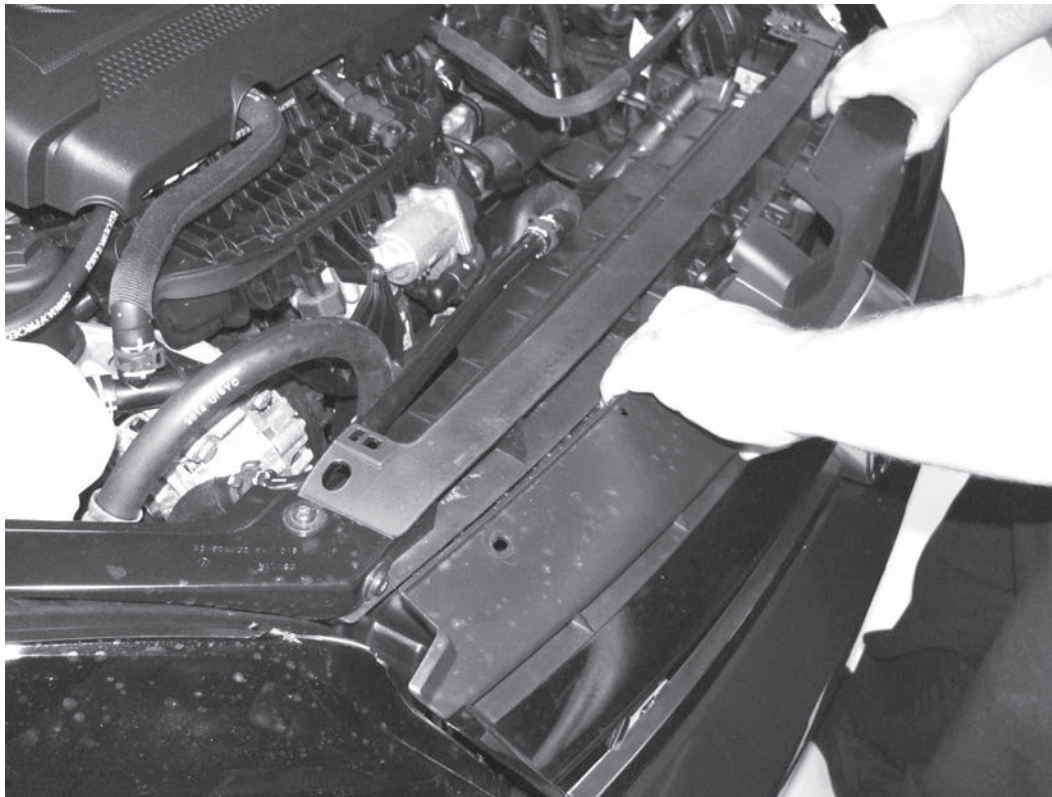

5) Lift the back of the grill, and then pull it forward to remove it from the car.

6) Remove the two T25 screws from the top of the bumper cover.

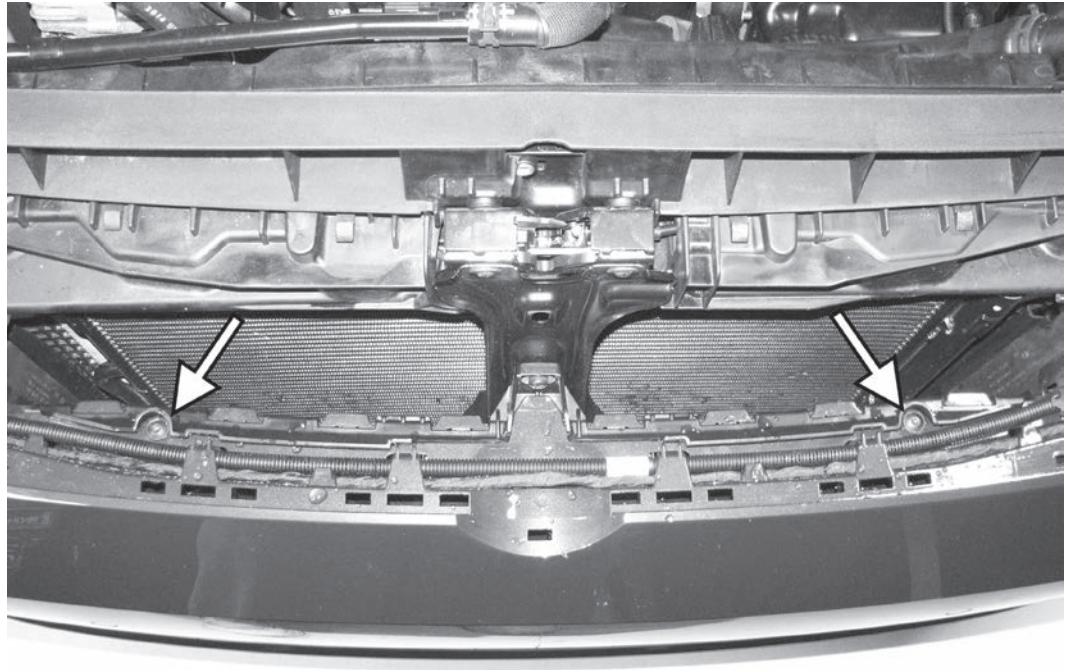

APR, LLC

4800 US HWY 280 West Opelika Alabama 36801

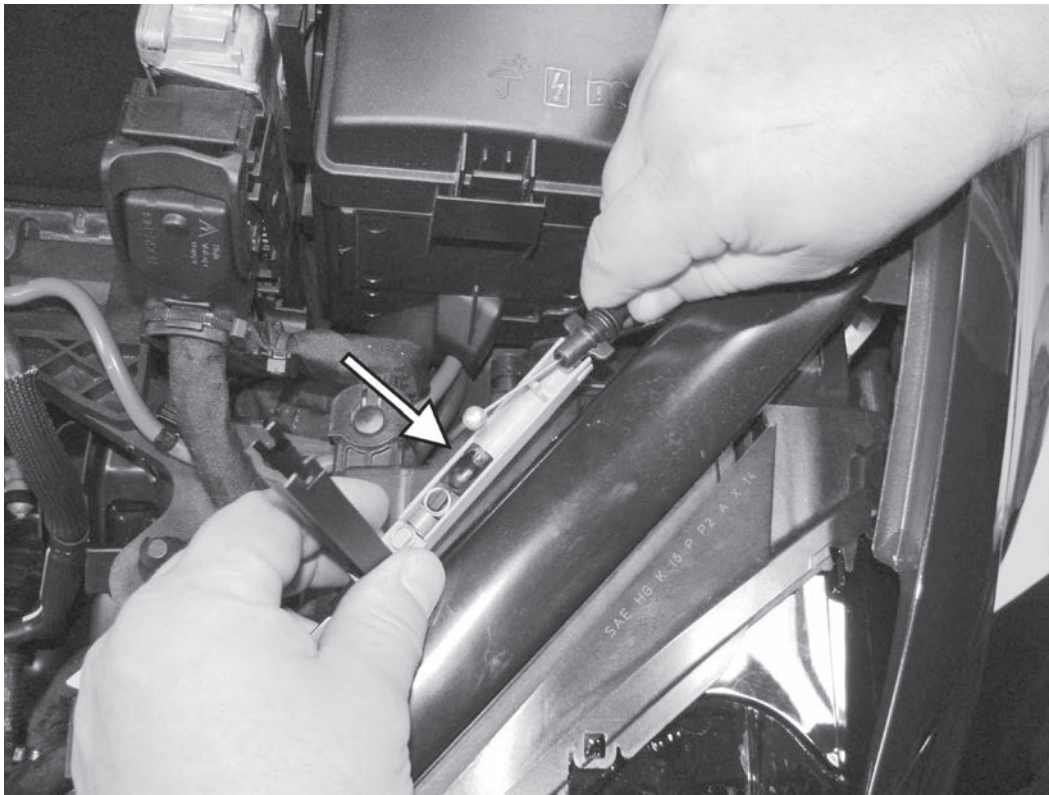

7) Pull the hood latch connection joint off of the upper core support bracket. Disconnect the hood cable by pulling the cable out of the latch side of the connection joint. The connection joint cover will flip open, and the ball end of the cable should separate from the joint.

NOTE: Do NOT close the hood with this joint disconnected!

8) Remove the six T30 screws from the upper core support brackets. Note that the rear bolts are longer, and mount the rear of the headlights. Once the bolts are removed, remove the upper core support brackets from the car.

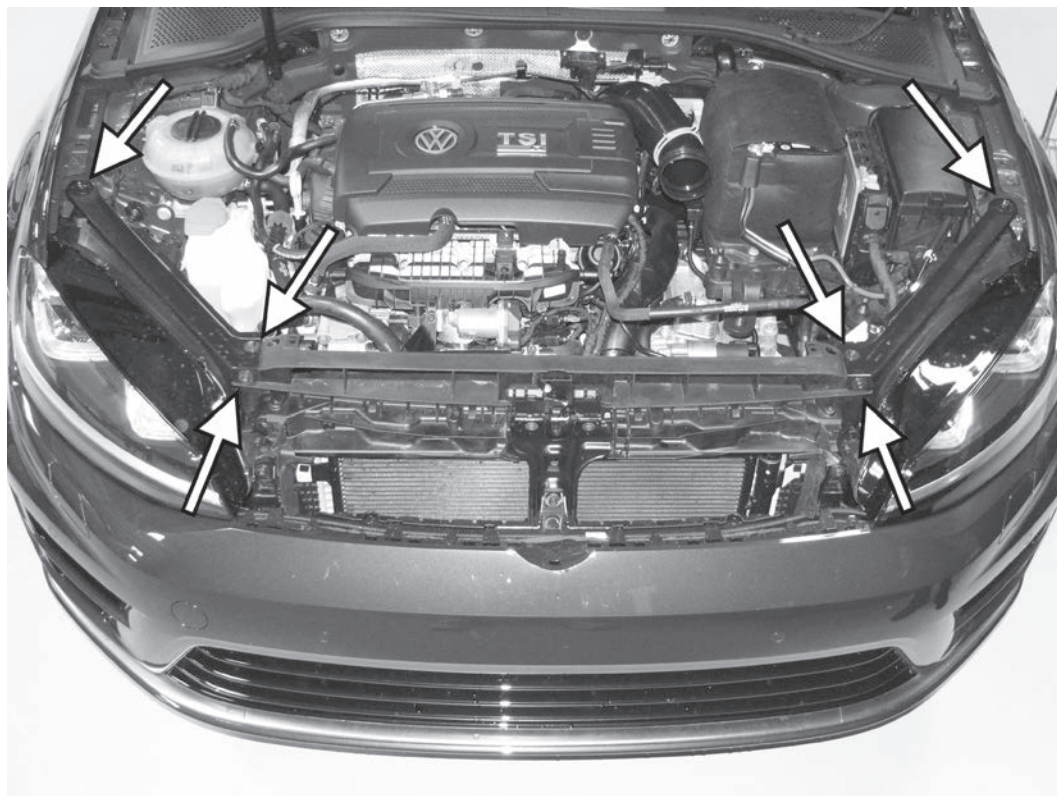

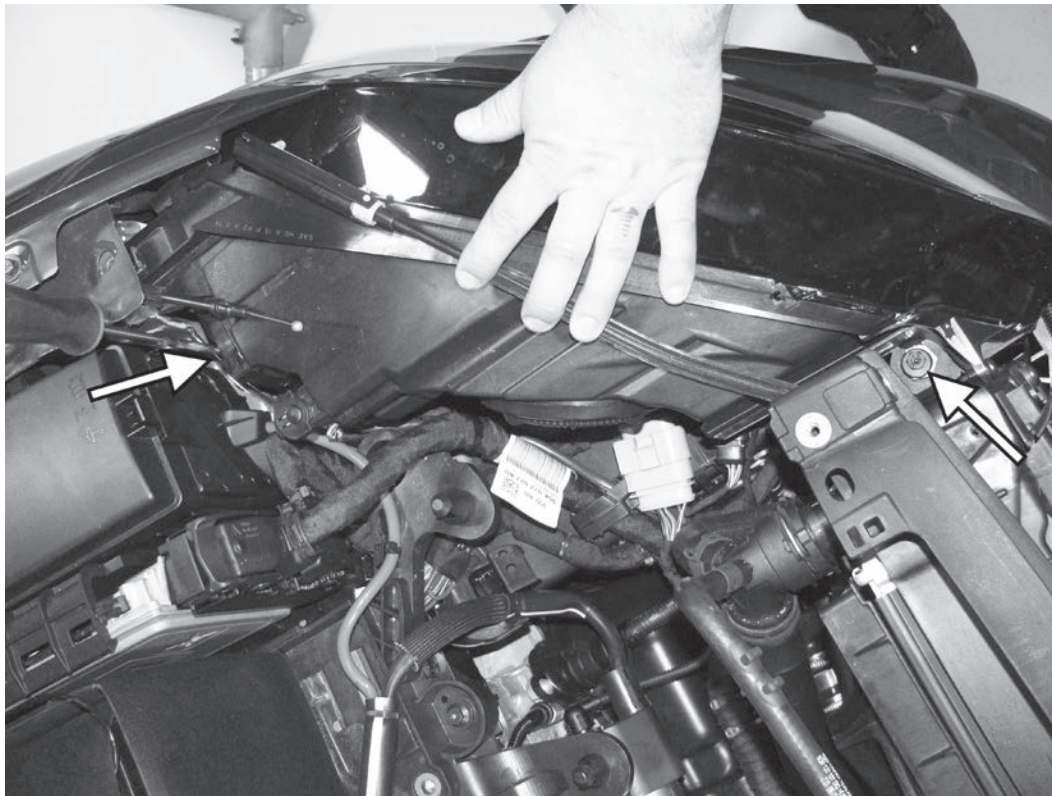

9) Remove the T30 screw from the front of both headlight assemblies. Loosen, but do not remove the T30 screws from the rear, lower part of both headlight assemblies.

10) Remove the eight T25 screws from the engine belly pan, and remove the belly pan from the car. Note how the belly pan snaps into the lower portion of the front bumper cover.

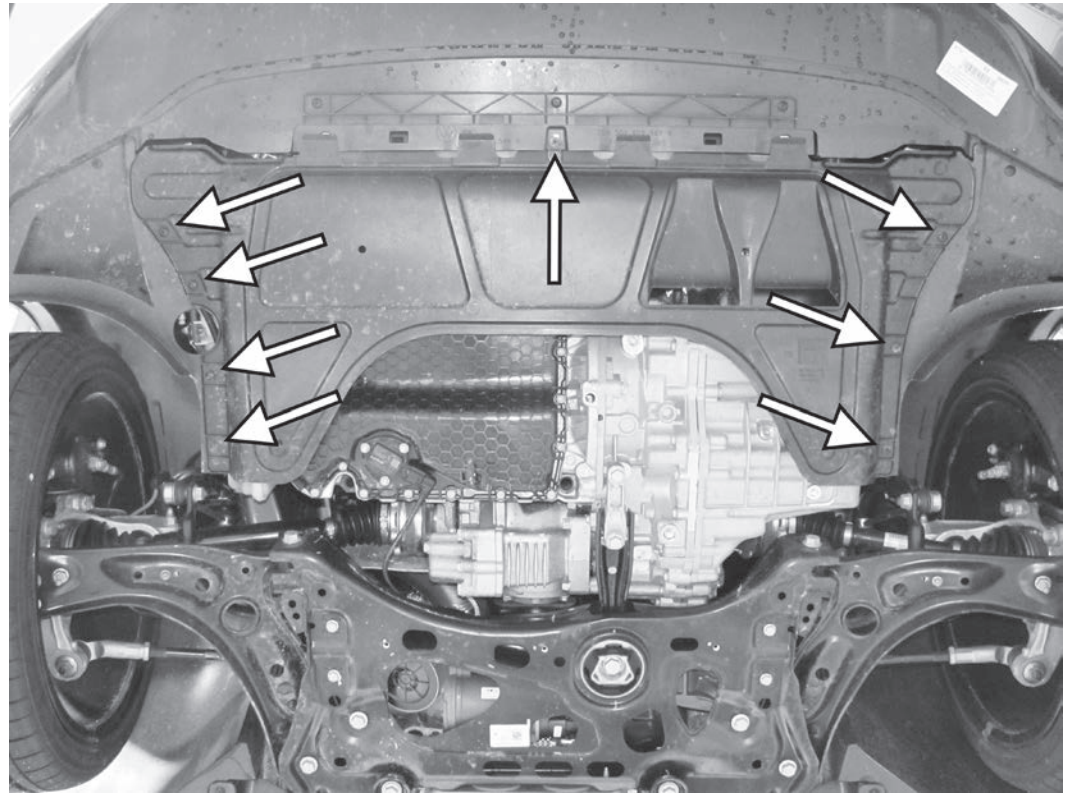

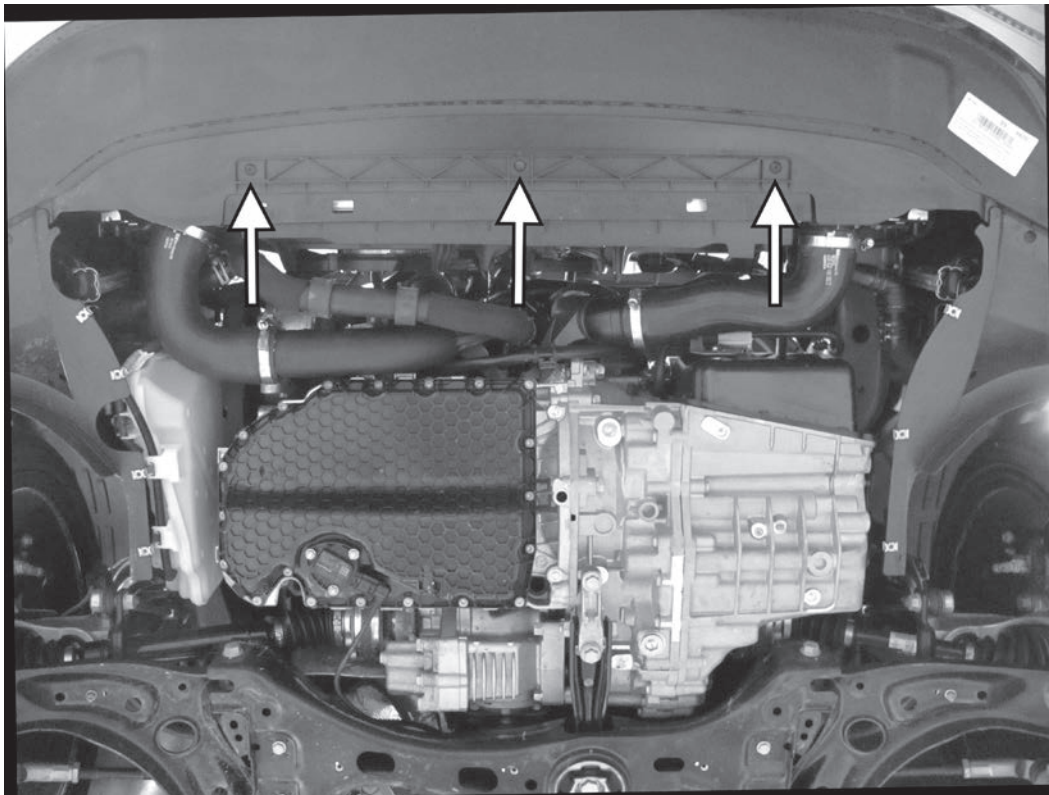

11) Remove the three T25 screws securing the bottom section of the bumper to the core support.

12) Remove both intercooler hoses from the car by removing the clamps on either end of the hoses and pulling the hoses off.

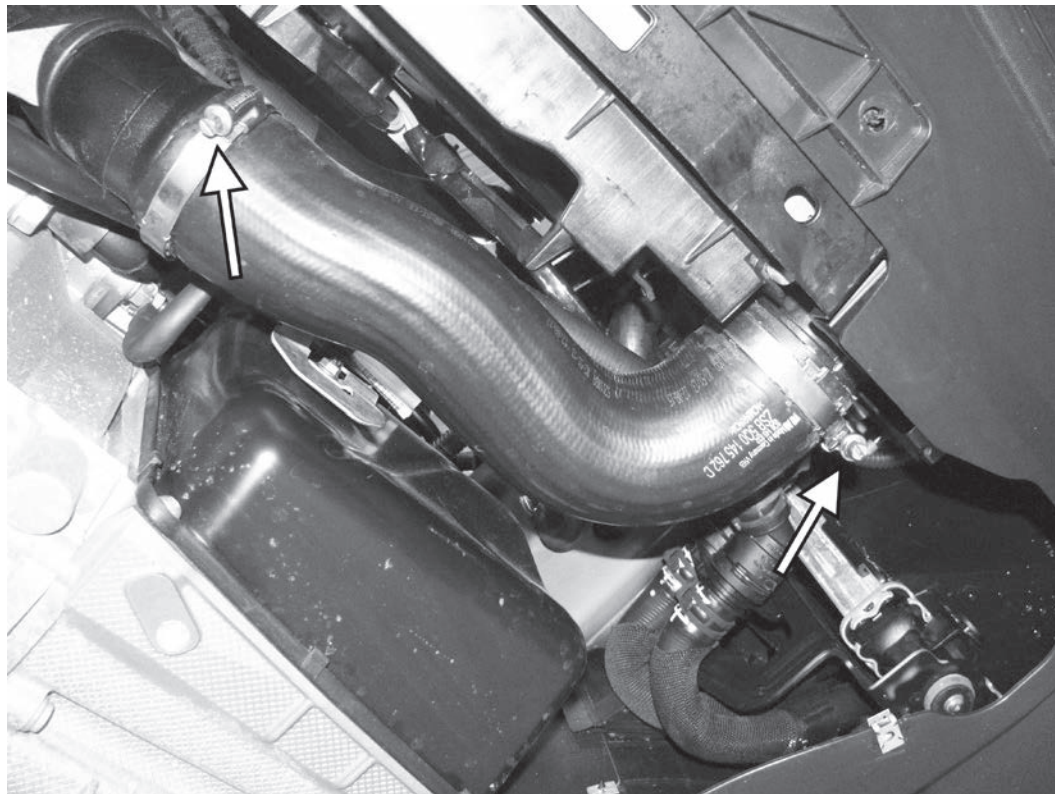

APR, LLC

4800 US HWY 280 West Opelika Alabama 36801

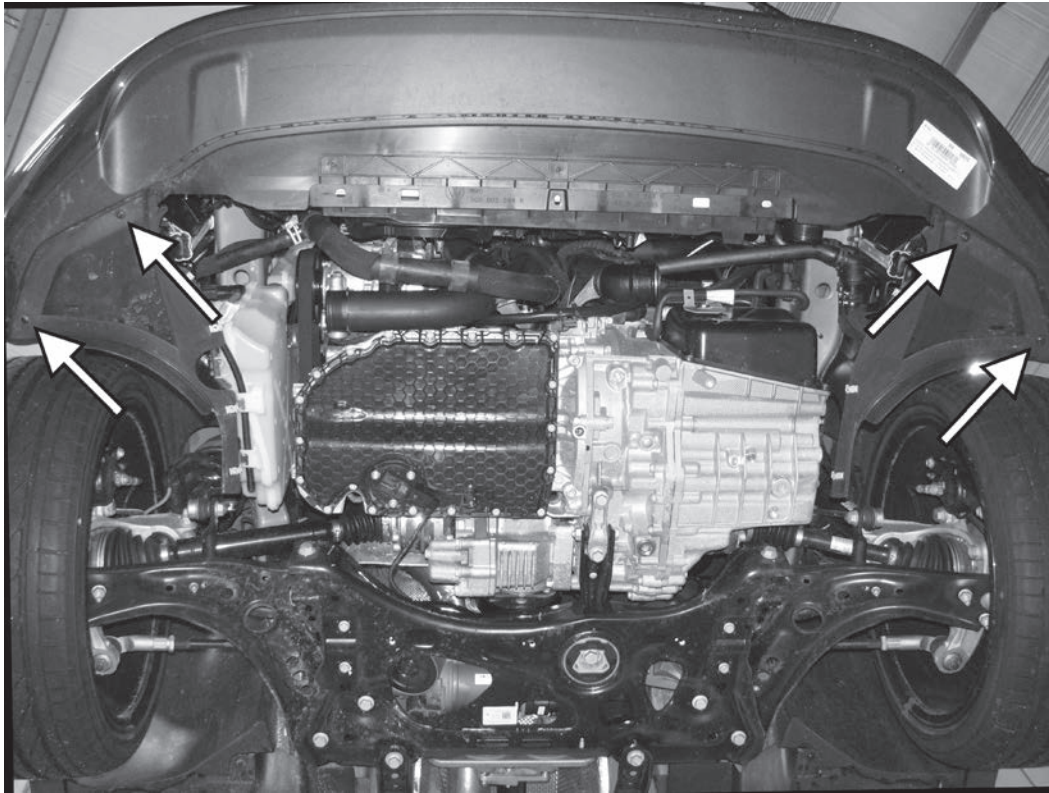

13) Remove the four T25 screws (two from either side) from the portion of the fender liners that connect underneath the car.

14) Turn the front wheel to the side to remove the five T25 screws inside the wheel well. (Wheel removed for pictures) Once the screws are removed, remove the lower portion of the fender liner from the car. Repeat on the opposite side.

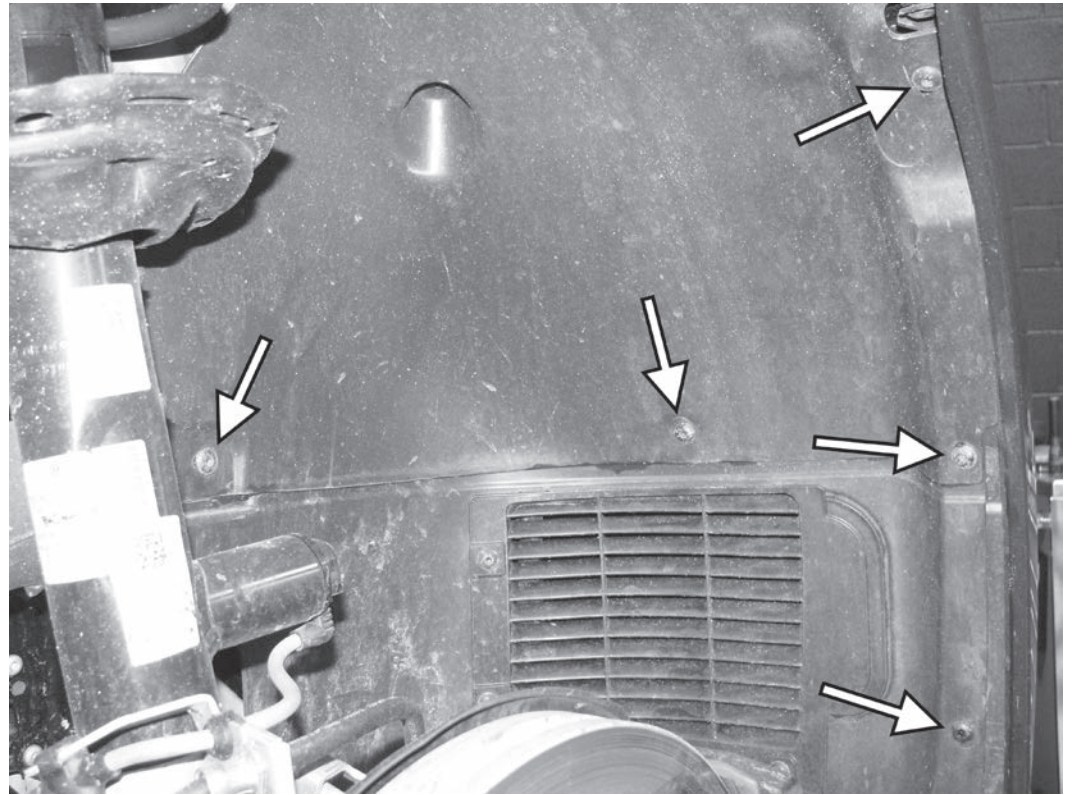



15) Pull back the fender liner, and remove the one T25 screw that holds the corner of the bumper cover to the front fender. Repeat on the opposite side.

16) If equipped, separate the black headlight washer line from the clips on the bottom of the washer fluid tank.

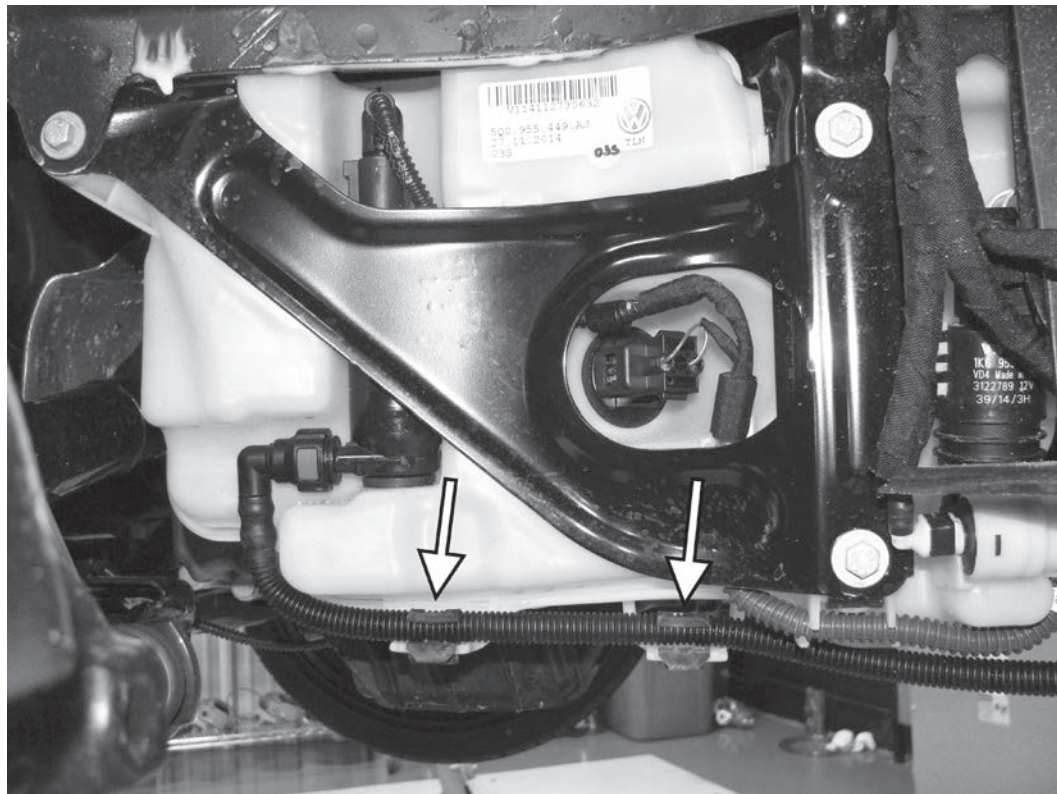

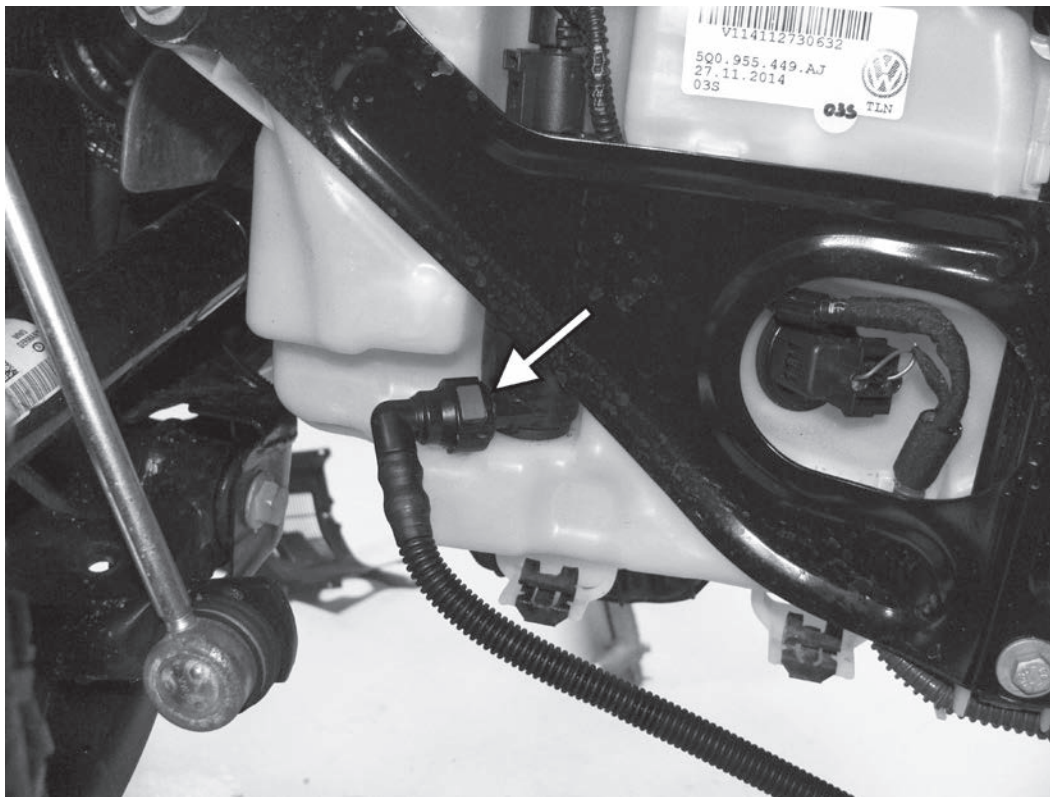

17) Rotate the washer pump nozzle slightly away from the bottom of the tank. Find the APR supplied rubber cap, then disconnect the washer tank line from the pump by squeezing on the two blue portions of the fitting. Install the APR rubber cap to prevent all of the washer fluid in the tank from draining out.

18) Carefully pull the upper corners of the bumper away from mounting brackets on both sides of the bumper.

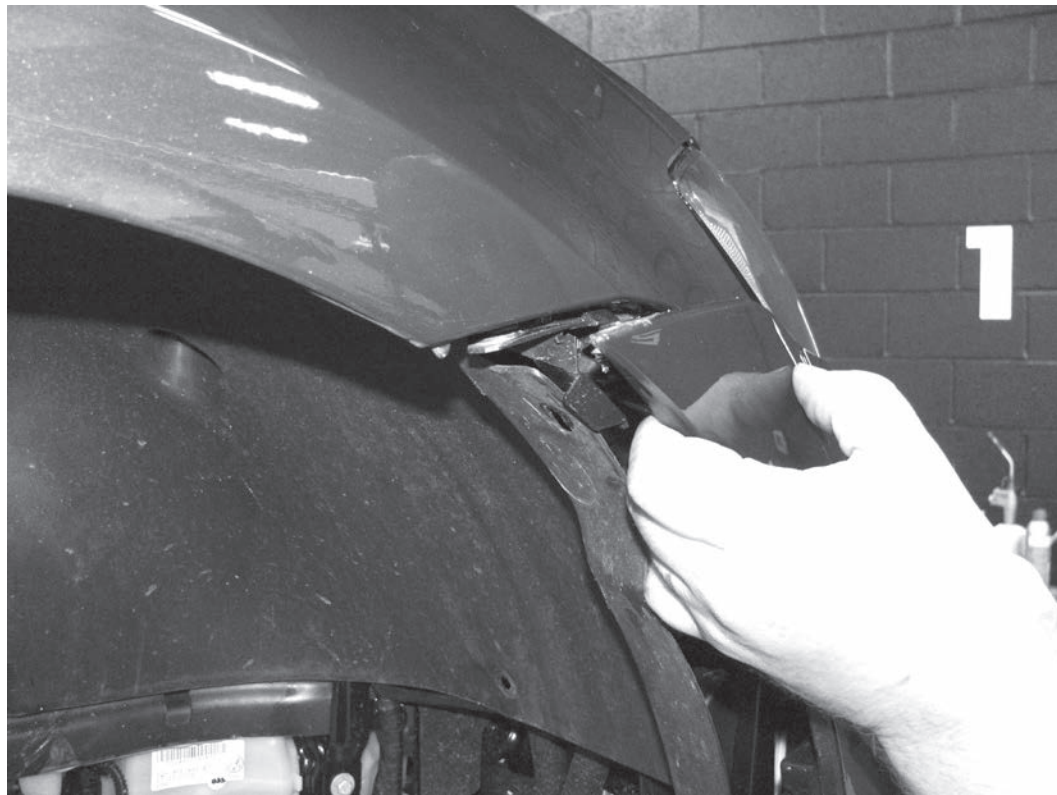

APR, LLC

4800 US HWY 280 West Opelika Alabama 36801



19) With an assistant, pull the entire bumper cover forward and away from the car.

20) If equipped, disconnect the electrical connector that goes to the front parking sensors.

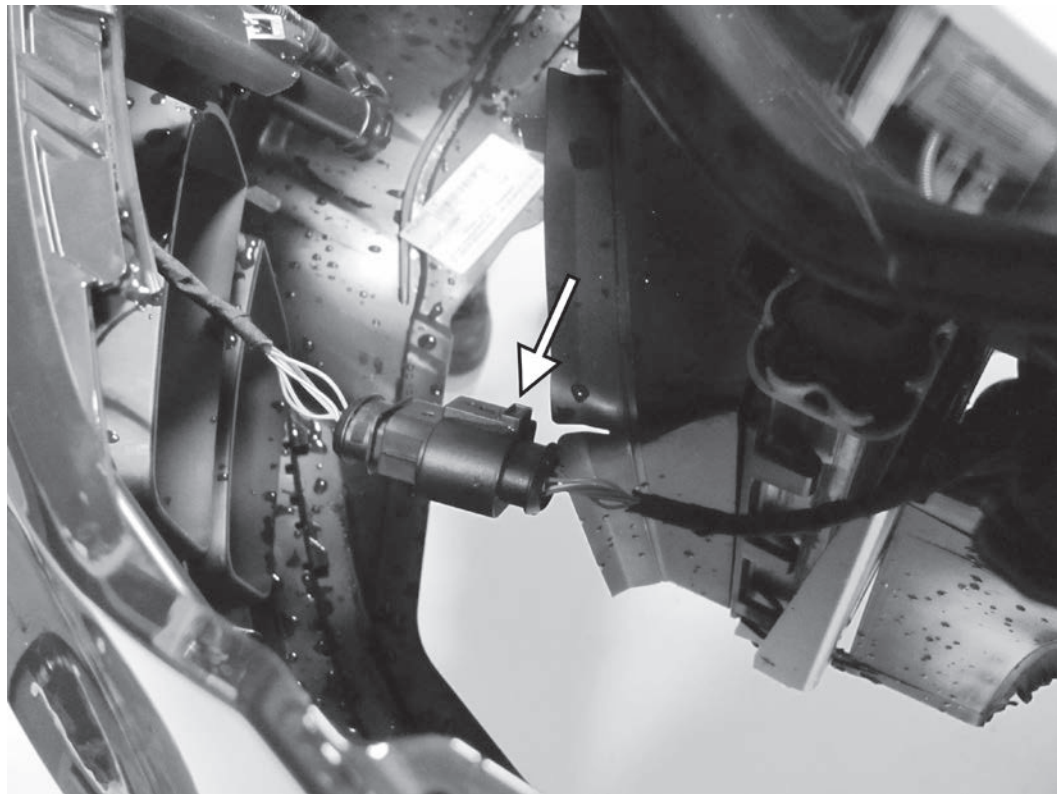



21) Place the bumper off to the side to avoid damage.

22) Remove the three T30 screws from the upper bumper support bracket, and remove the bracket from the car.

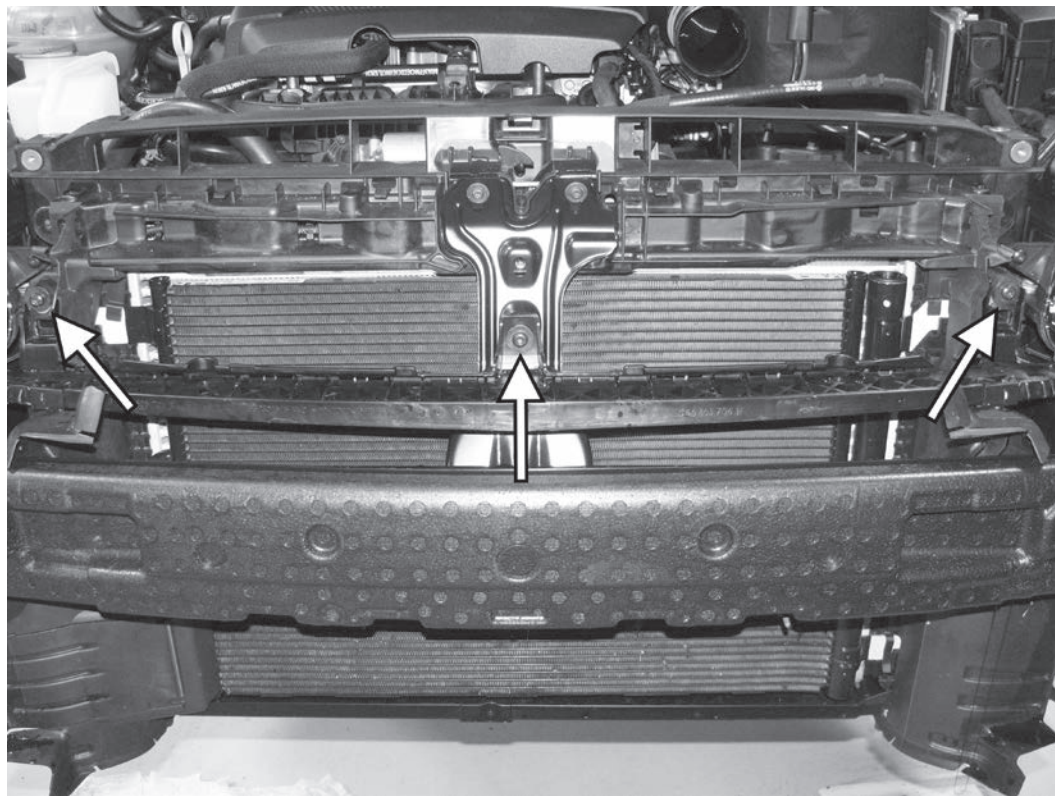

APR, LLC

4800 US HWY 280 West Opelika Alabama 36801

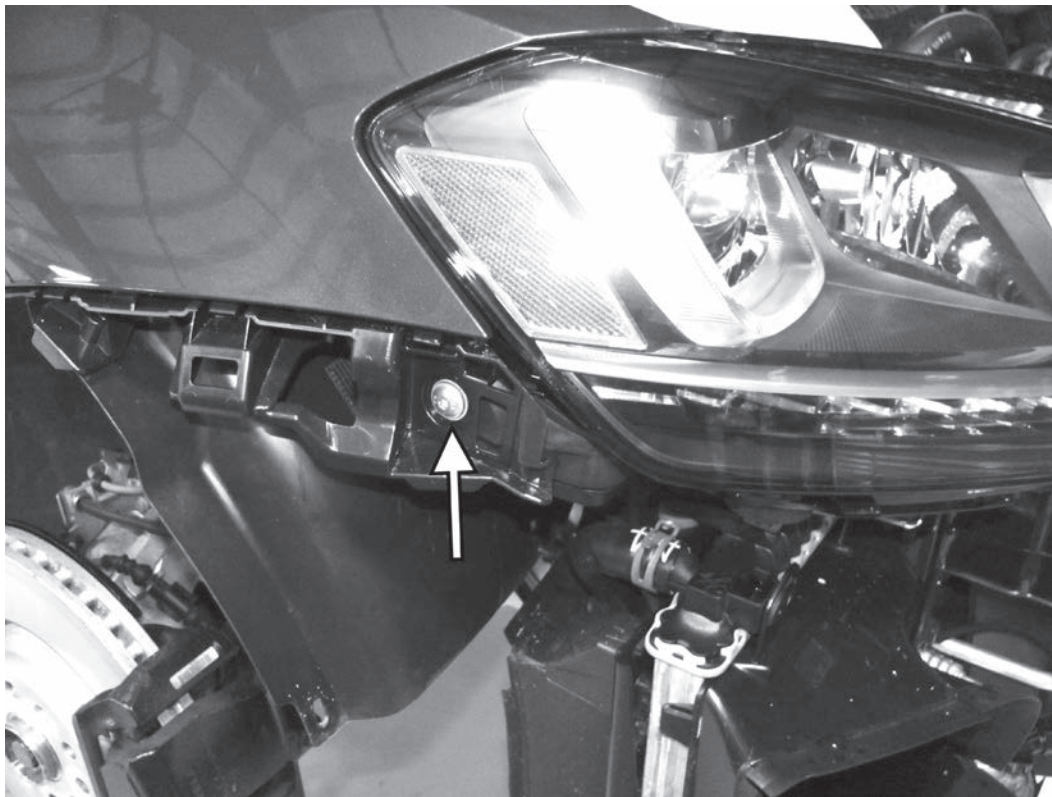

23) Remove the T30 screw from the side of both headlights.

24) Carefully slide the headlights forward. Disconnect the electrical connectors on the back of the headlights, and remove the headlights from the car.



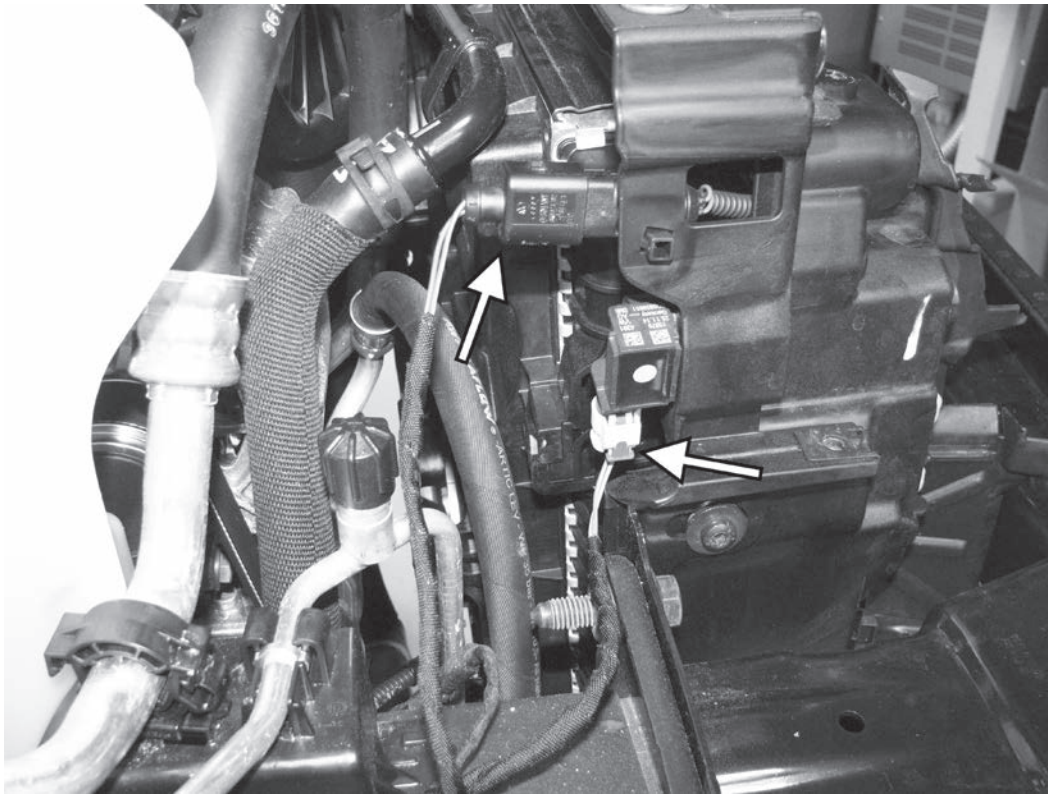

25) Disconnect the electrical connector to the hood latch on the right side of the radiator core support. On the yellow crash sensor, pull the locking tab away from the connector, and then disconnect the connector. Then, locate and disconnect the crash sensor on the left side of the core support.

26) Disconnect the electrical connector to the outside air temperature sensor. Separate the harness to the sensor from the front bumper beam. Disconnect the electrical connectors to both horns, on either side of the core support.

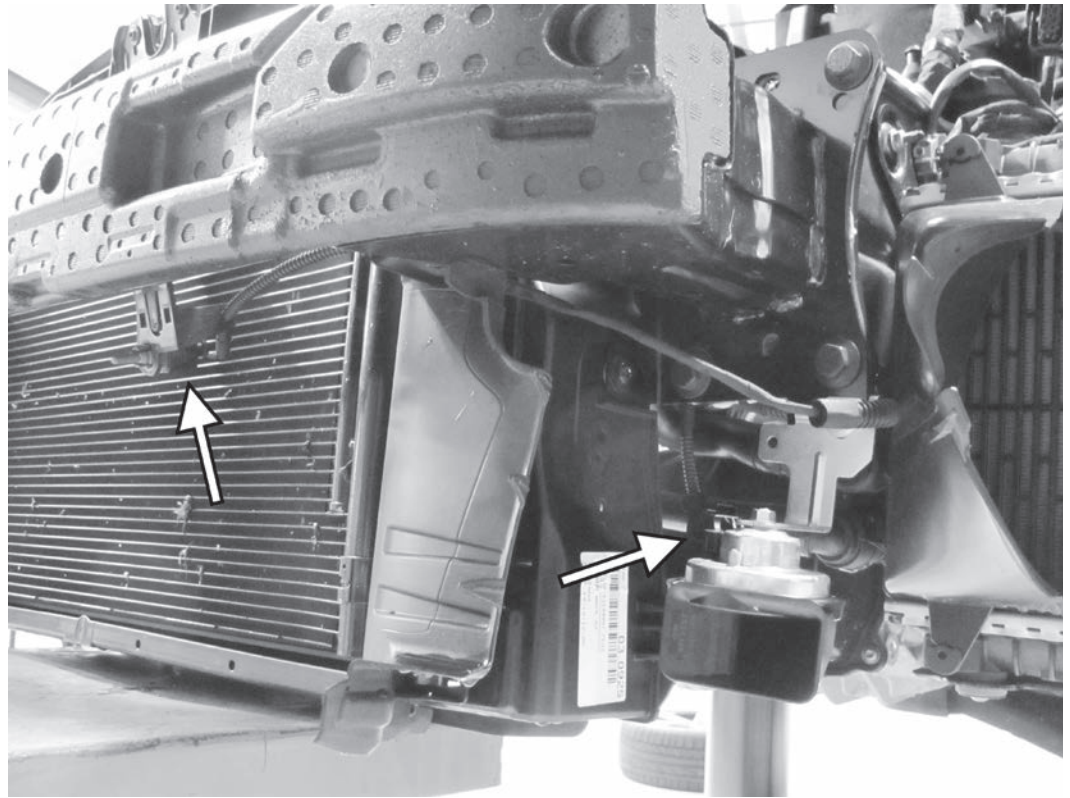

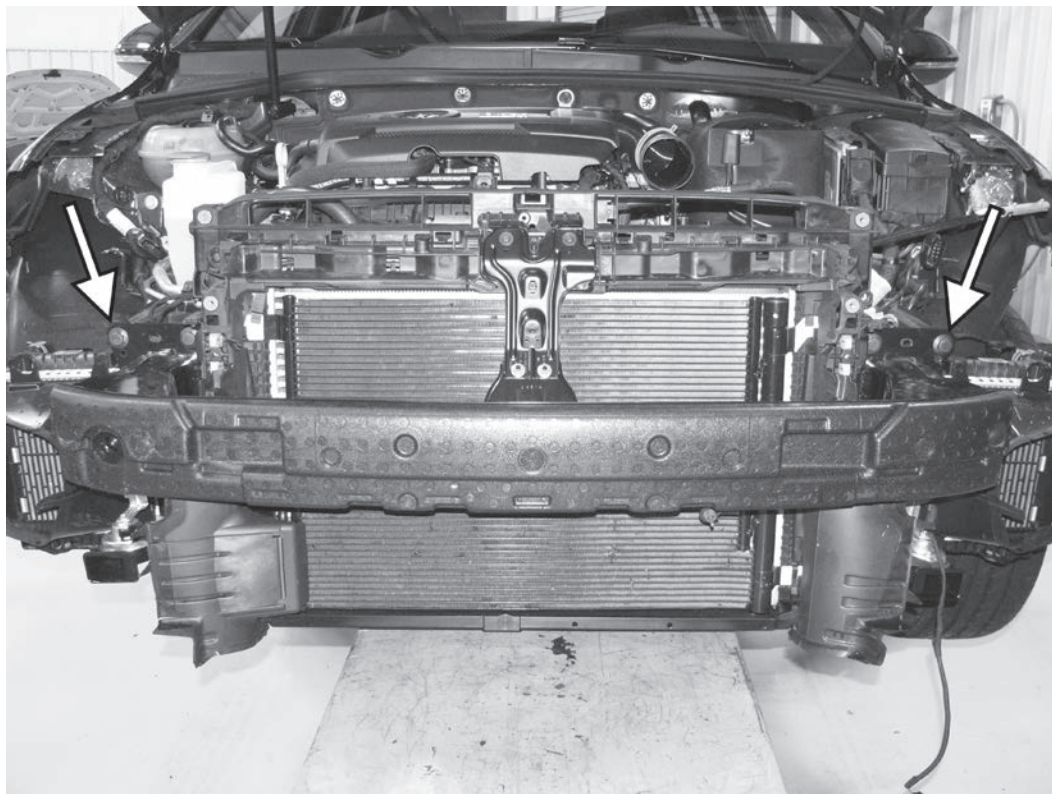

27) Remove the two upper, outer 16mm bolts from the front crash beam. Replace these bolts with the two supplied long APR bolts. Place a table or some other support under the bottom of the radiator/core support.

28) Remove the six remaining (three on each side) 16mm bolts from the front core support.

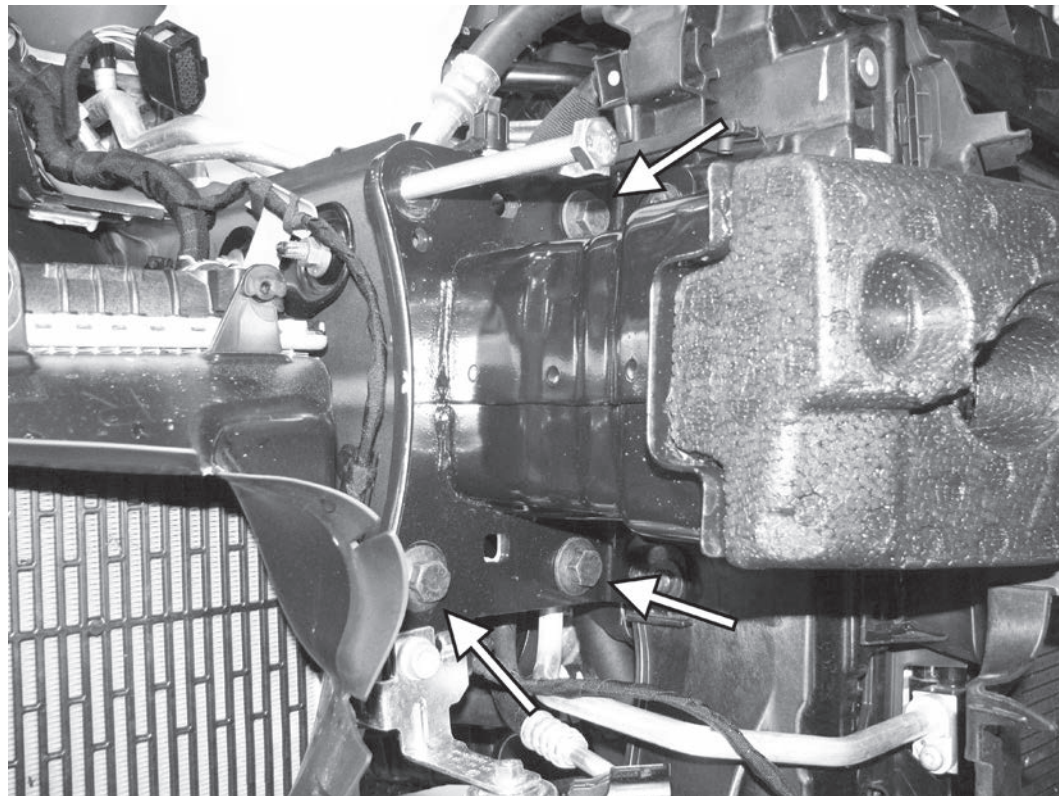

APR, LLC

4800 US HWY 280 West Opelika Alabama 36801

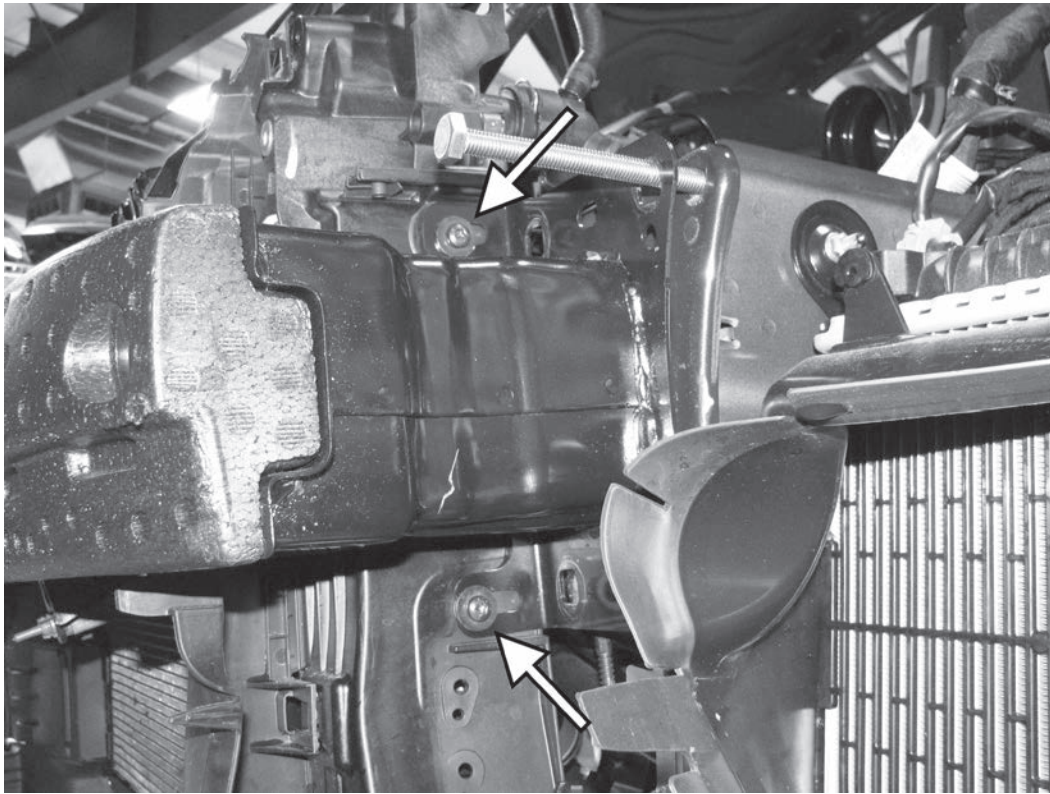

29) Remove the four (two on either side) T30 screws holding the sides of the core support to the crash beam. Note or mark where these bolts were located originally.

30) Remove the two T30 screws holding the top of the crash beam to the core support.

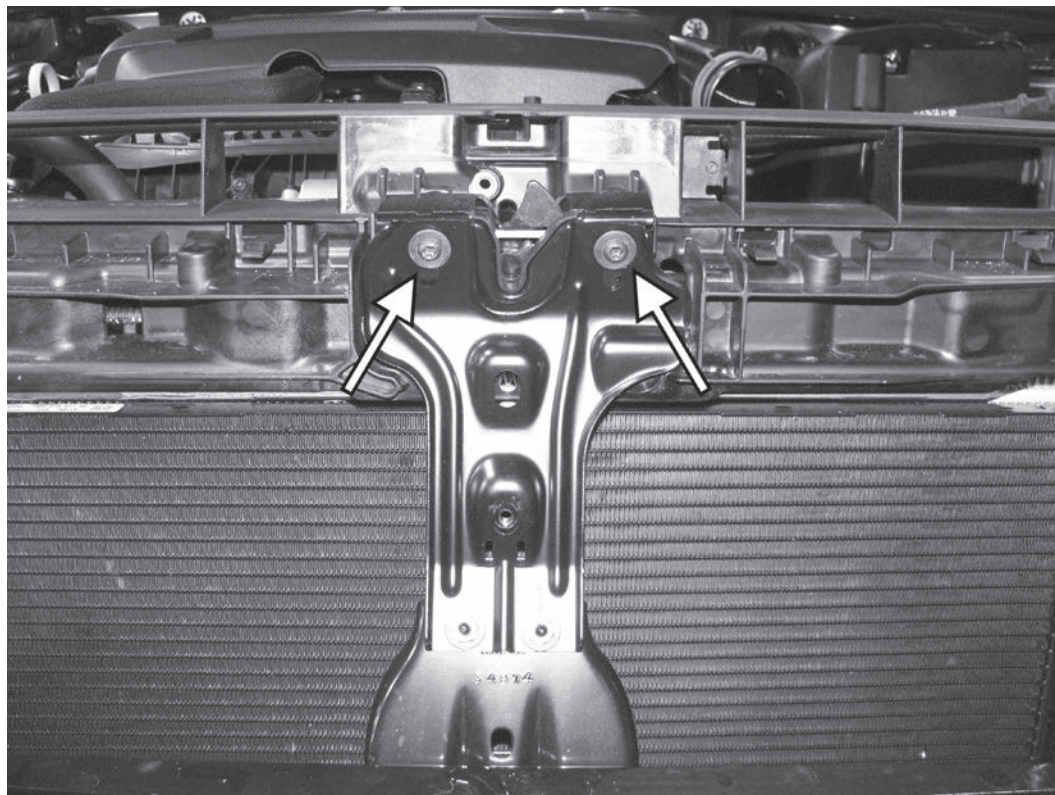

APR, LLC

4800 US HWY 280 West Opelika Alabama 36801

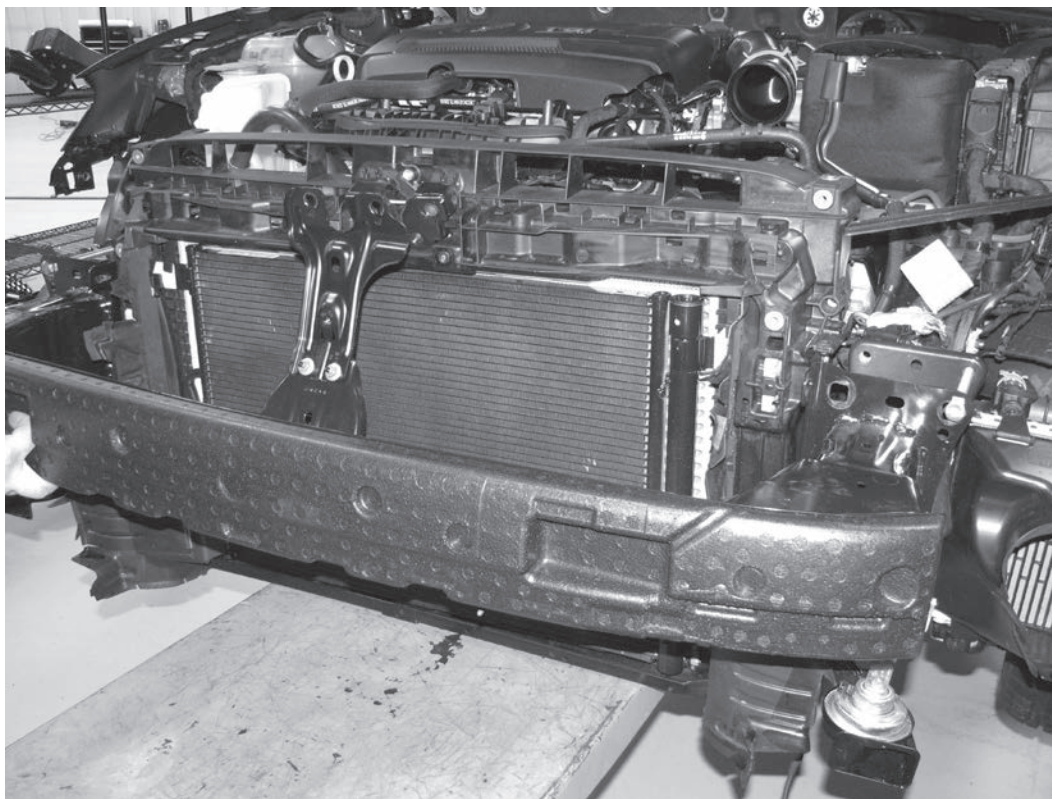

31) Slide the crash beam forward and then remove the two long APR bolts holding it to the car. Remove the crash beam to the car and set aside.

32) Remove both air guides from either side of the core support using a screwdriver to pry the clips open. There are three clips on each side air guide.

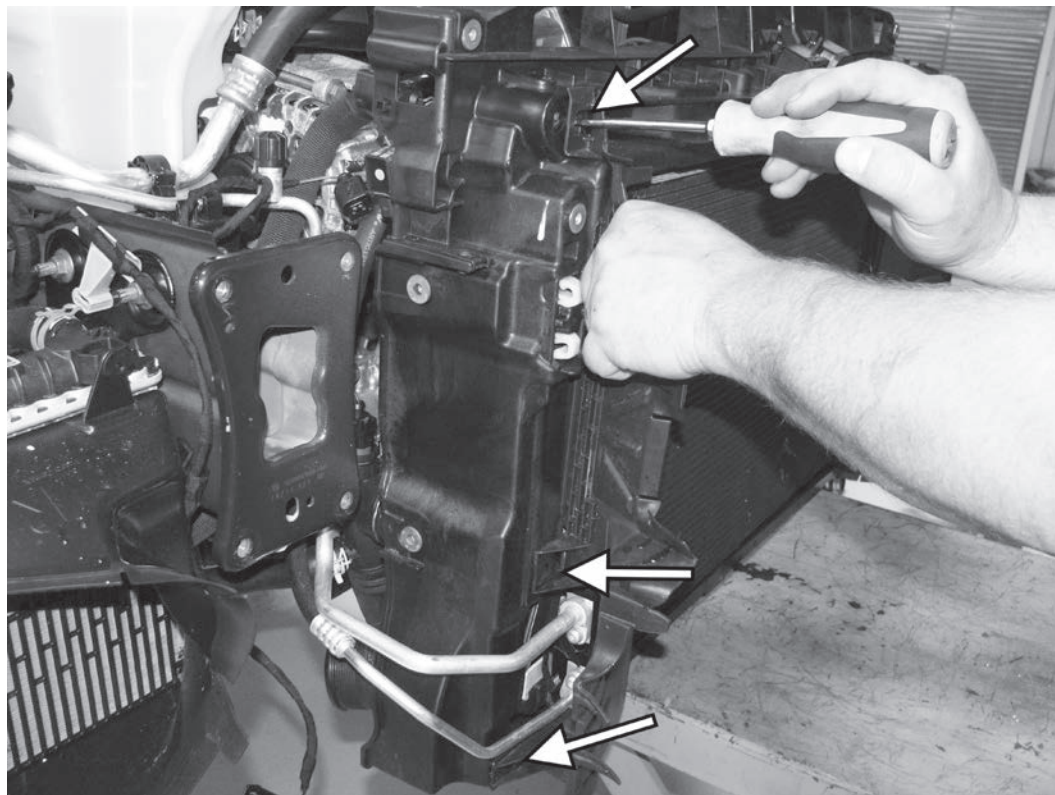

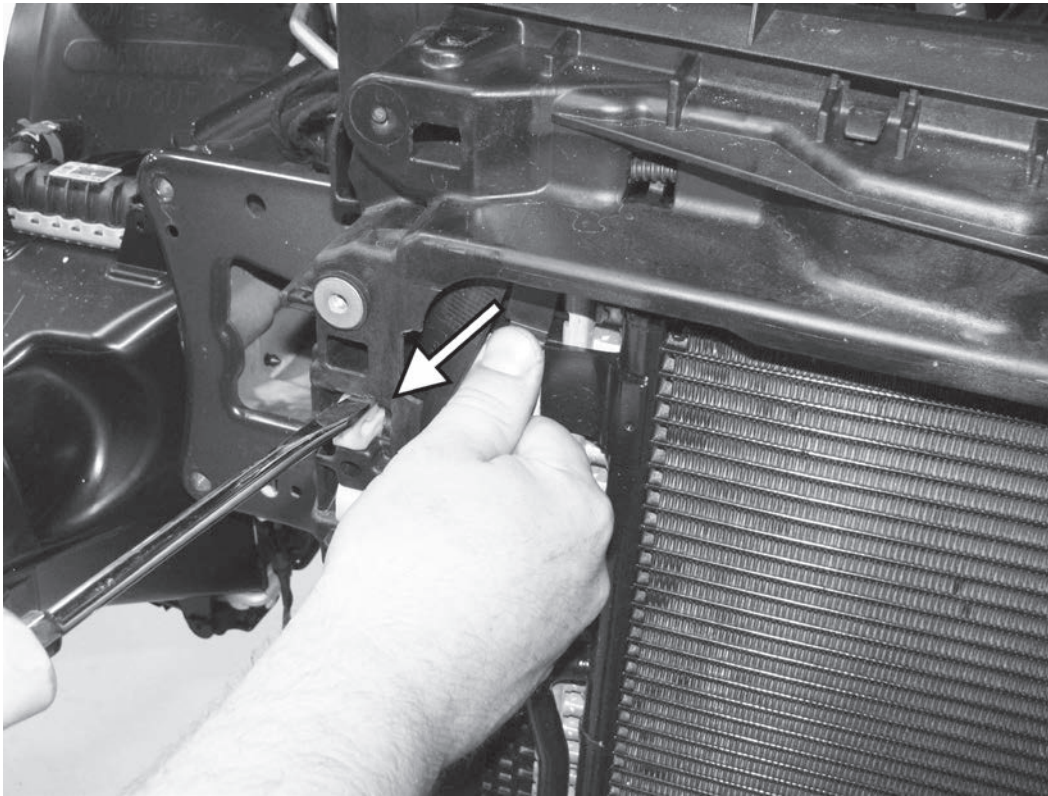

33) Using a large flat screwdriver, pry down on the top of the side intercooler clips while pushing the intercooler back and pulling the core support forward. Once the top tab of the clip is released, keep steady pressure pushing the intercooler back. Push up on the bottom tab of the clip to release from the core support.

34) Remove the side intercooler clip on the opposite side. Again, some force will be needed to press the upper and lower tabs in enough to separate the clips from the core support.

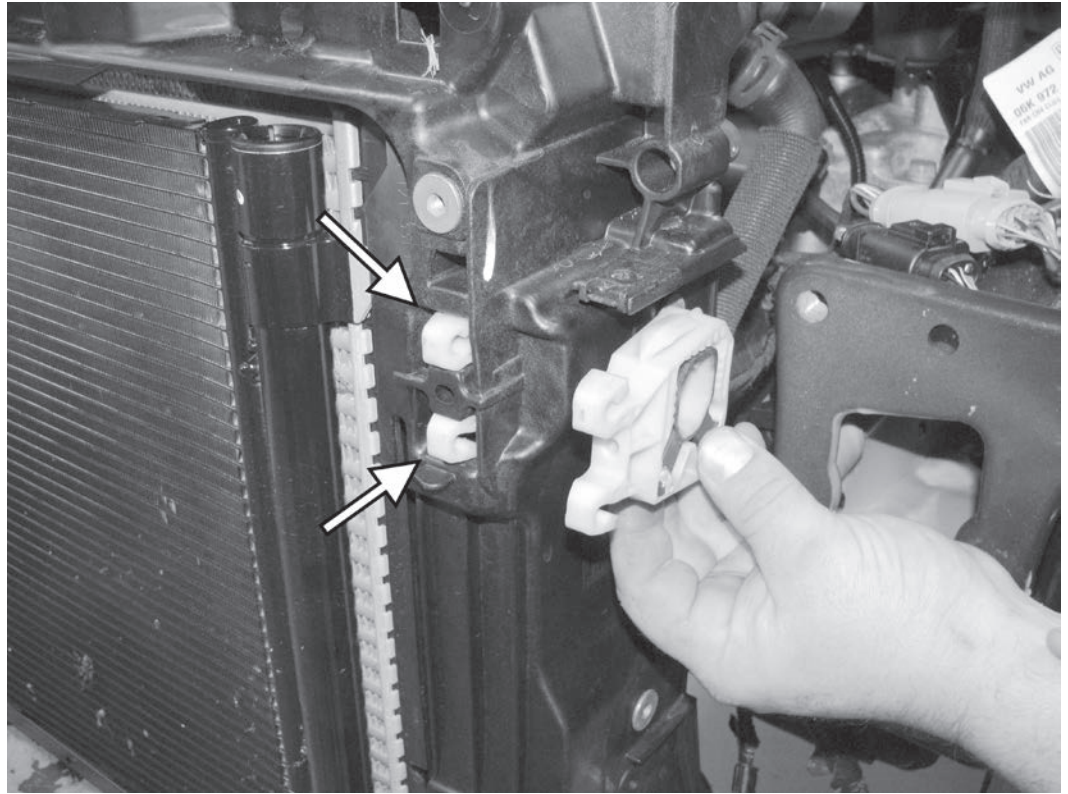

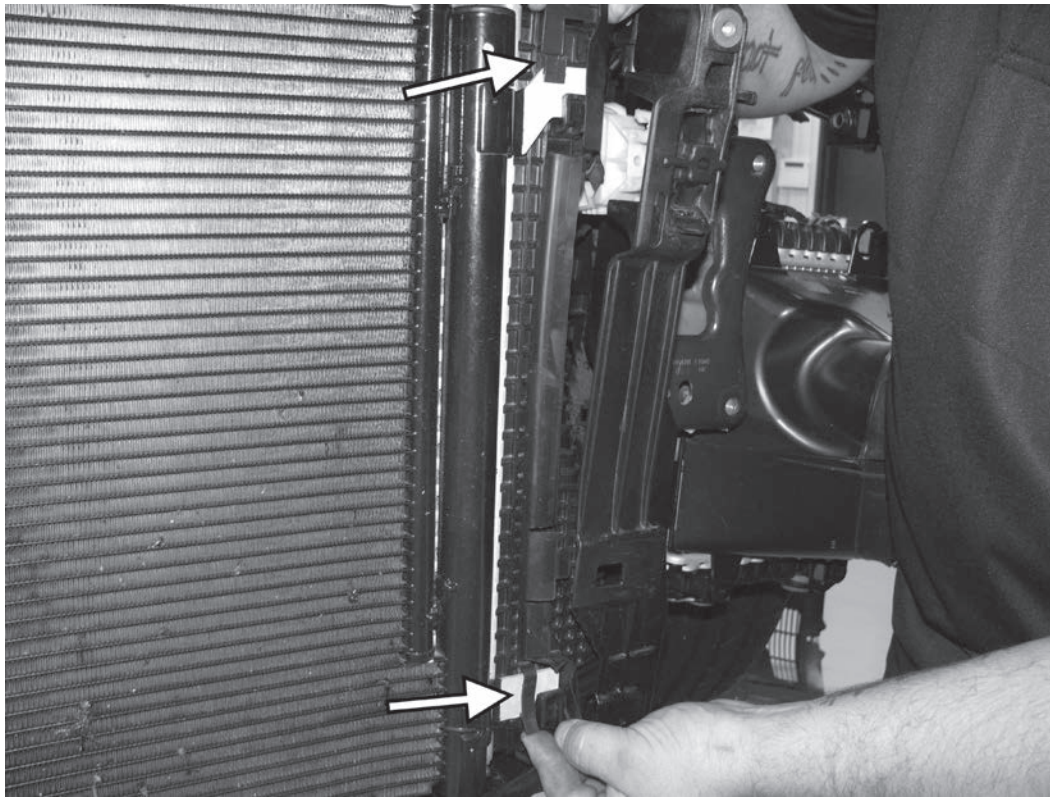

35) Remove the plastic guides that cover the A/C condenser mounting tabs. Simply lift up on the tabs of the guide and lift to remove the guides from the condenser.

36) Press in on the upper tabs on the stock intercooler to release the A/C condenser. With the tabs pressed in, lift the condenser to remove it out of both the upper and lower tabs. Repeat this on both sides of the condenser.

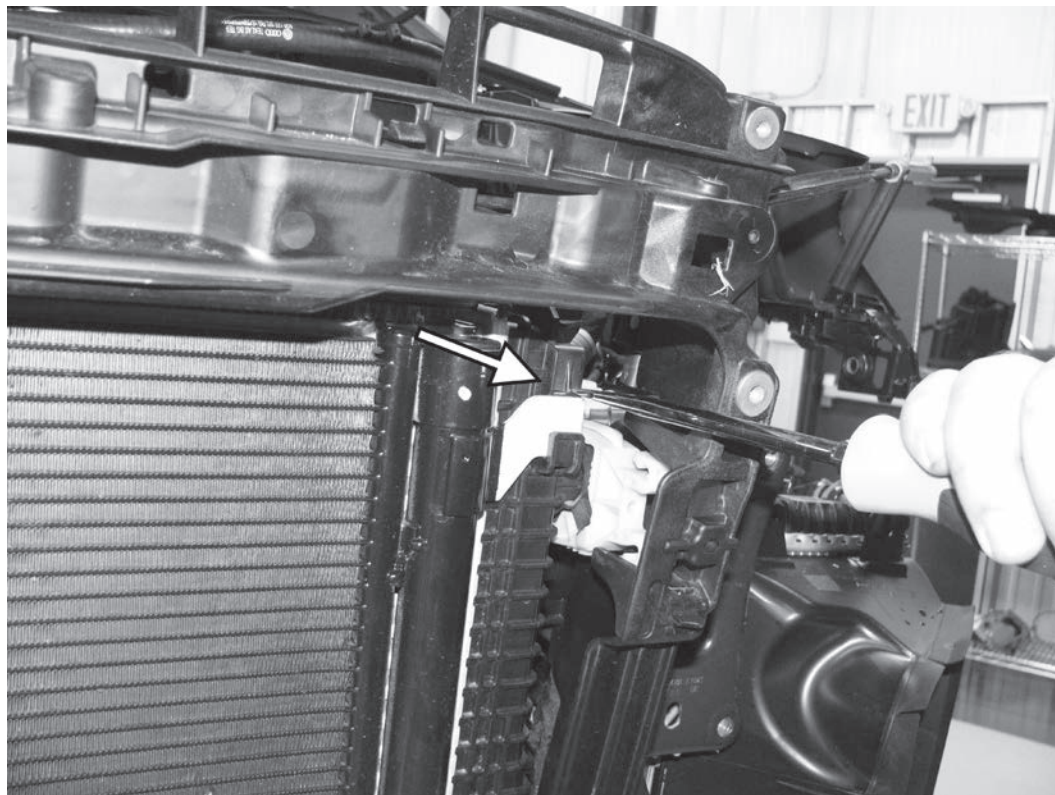

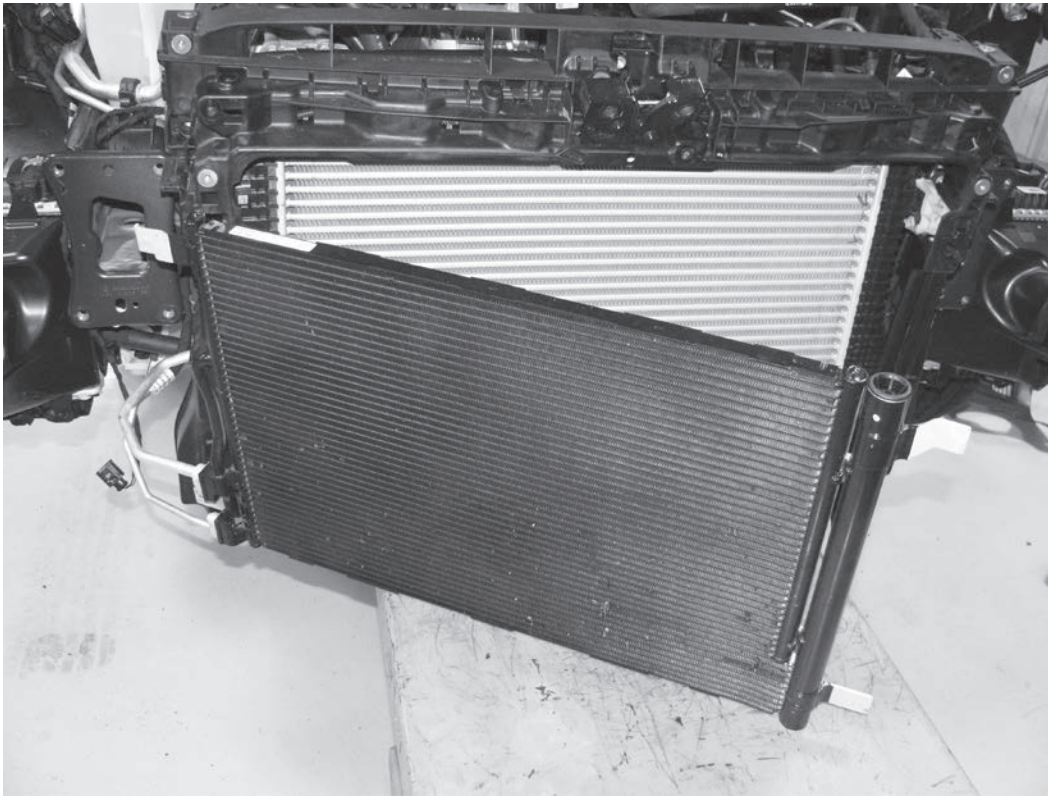

37) Manuever the A/C condensor out from behind the core support, and swing it out of the way.

38) Slide the core support forward away from the intercooler and radiator. Lower the core support so the posts from the intercooler come out of the grommets in the core support and remove the core support from the car.

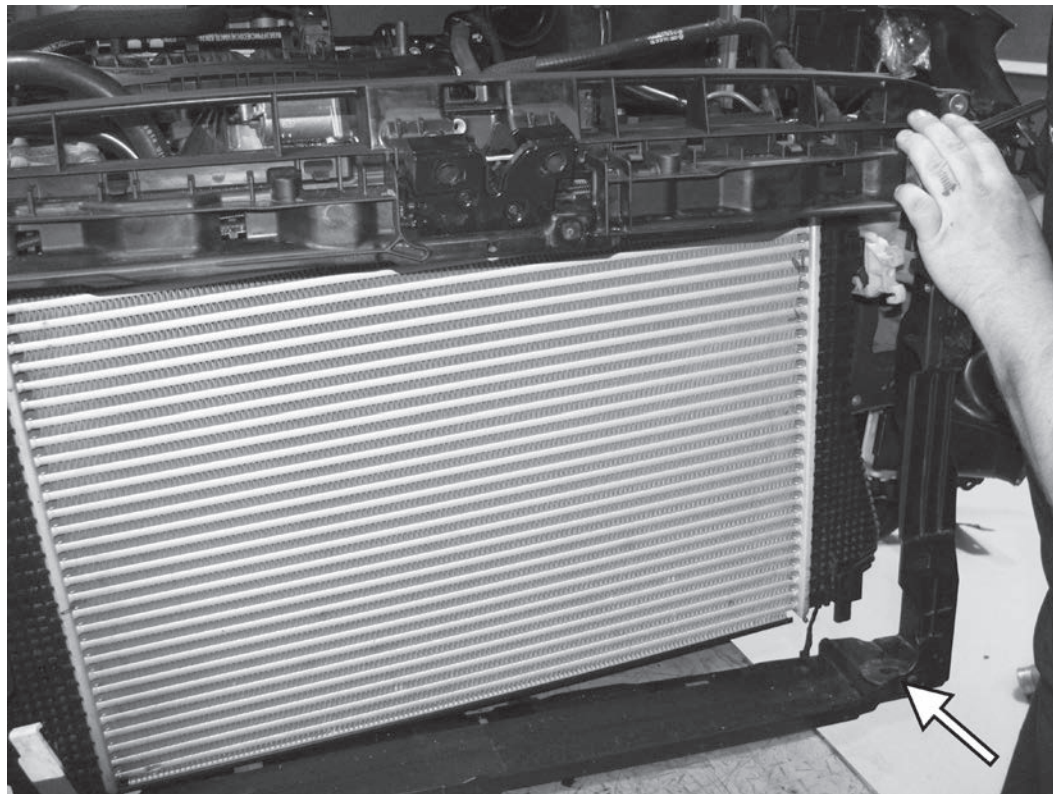

APR, LLC

4800 US HWY 280 West Opelika Alabama 36801

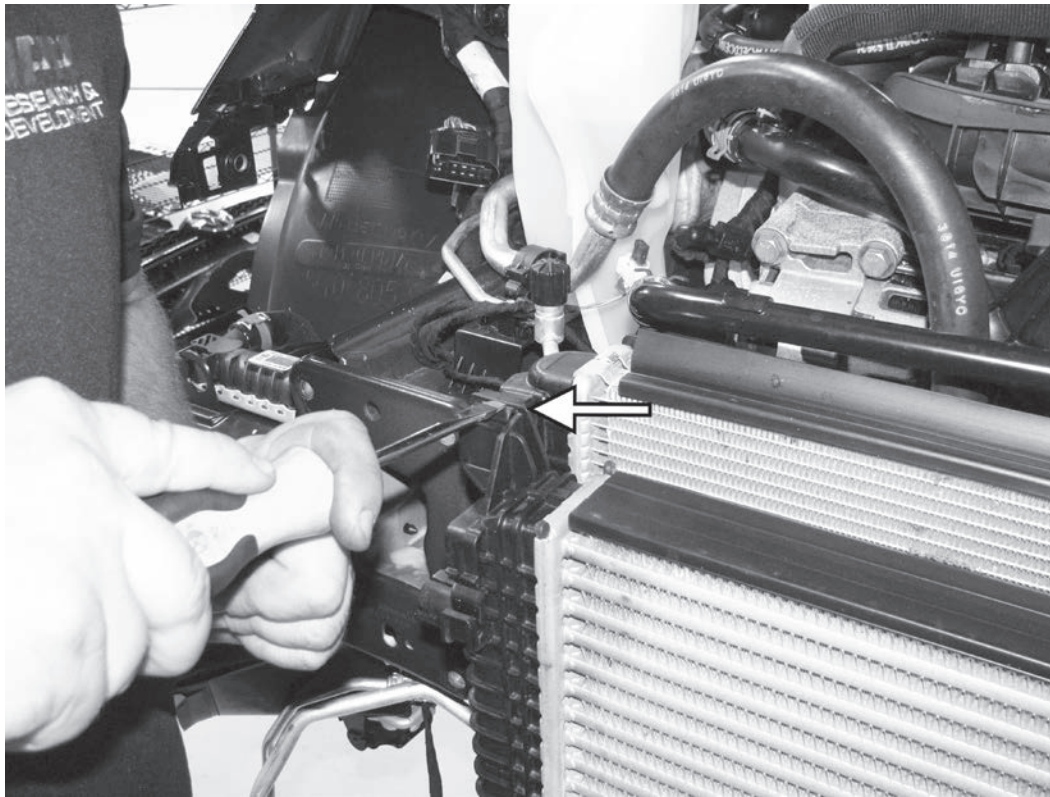

39) Using a screwdriver, press to release the two tabs holding the stock intercooler to the radiator. Lower the intercooler from the radiator and remove the intercooler from the car.

40) Install 2" of the supplied heat shrink tubing on each of the lower mounting tabs of the A/C condenser. Heat the tubing to secure it in place.

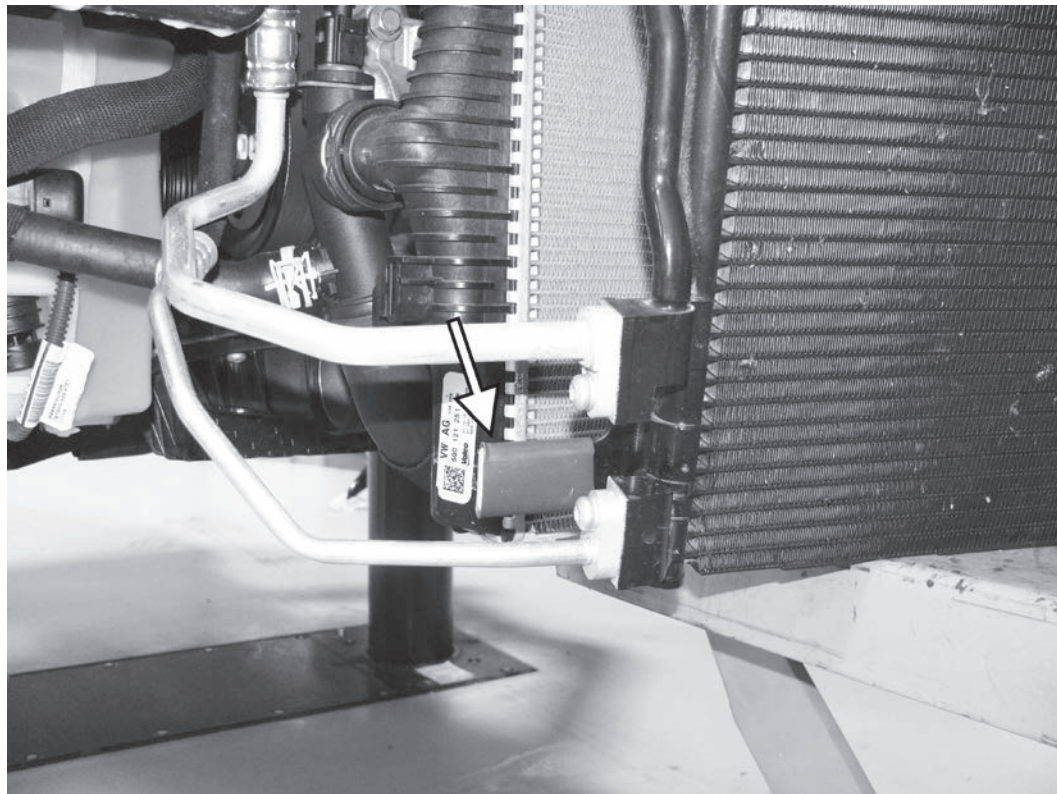

APR, LLC

4800 US HWY 280 West Opelika Alabama 36801

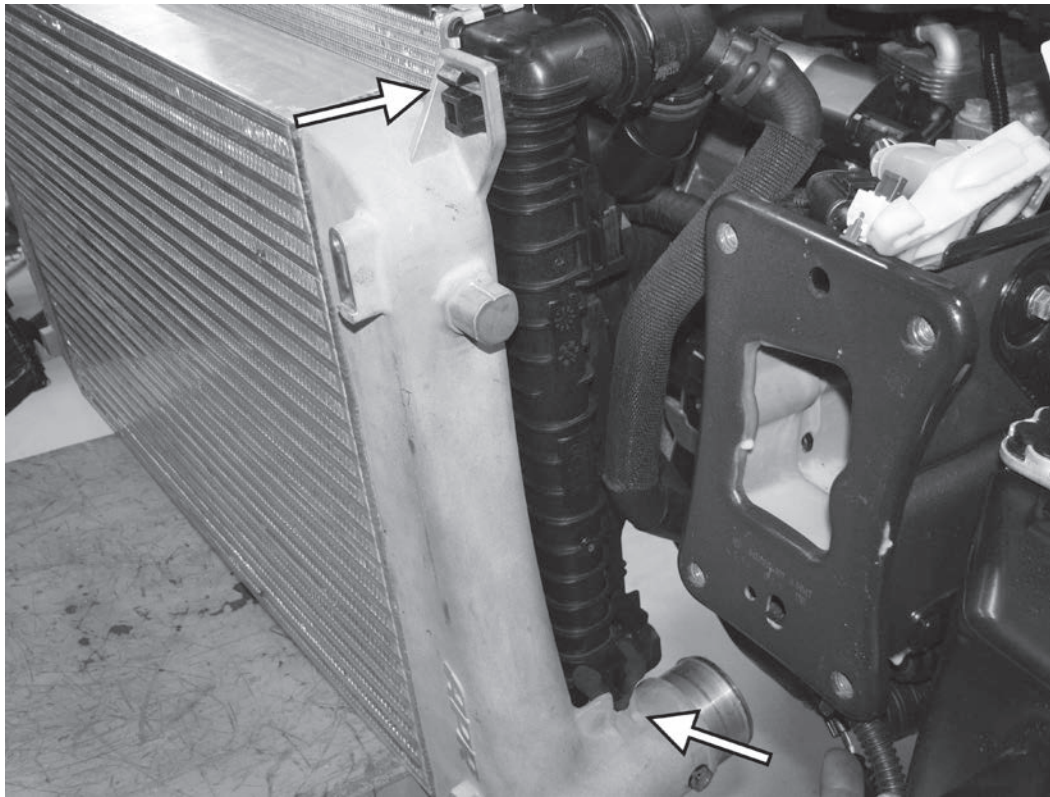

41) Install the APR intercooler to the factory radiator by first lowering the mounting tabs from the stock radiator into the slots on the APR intercooler. Then swing the top of the APR intercooler back into the upper clips of the radiator and then snap the intercooler into place.

42) After removing them from the stock intercooler, slide the stock intercooler clips onto the posts on the side of the APR intercooler.

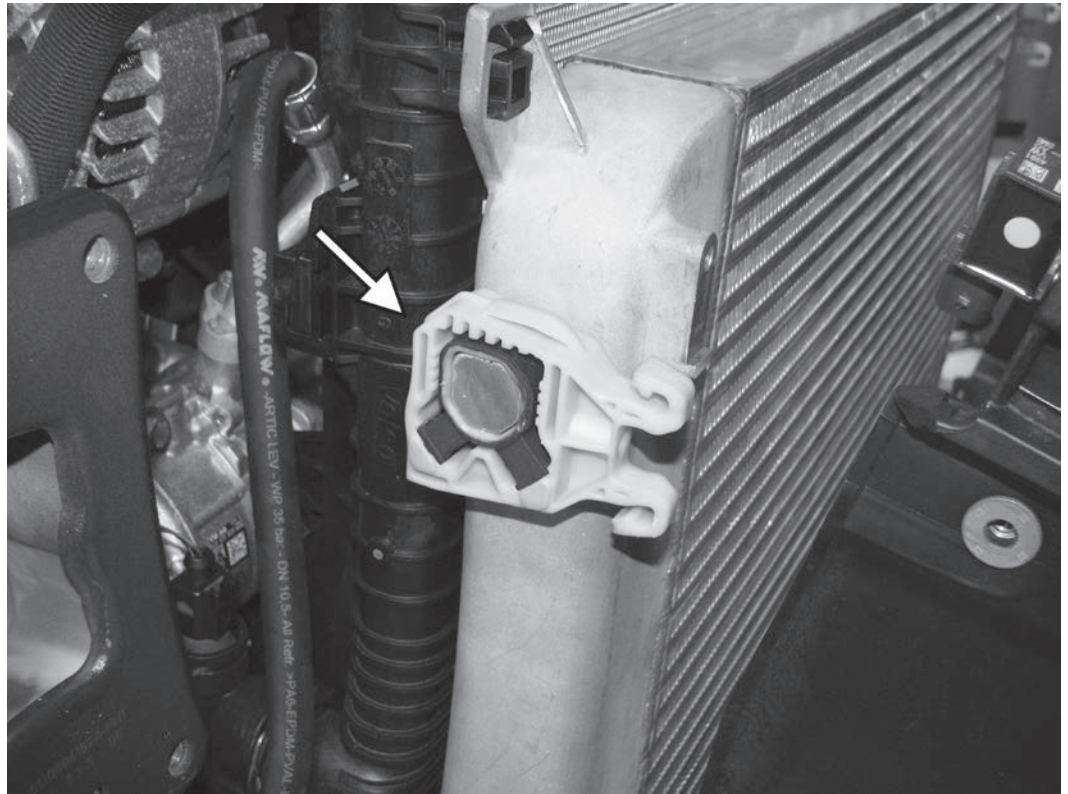

APR, LLC

4800 US HWY 280 West Opelika Alabama 36801

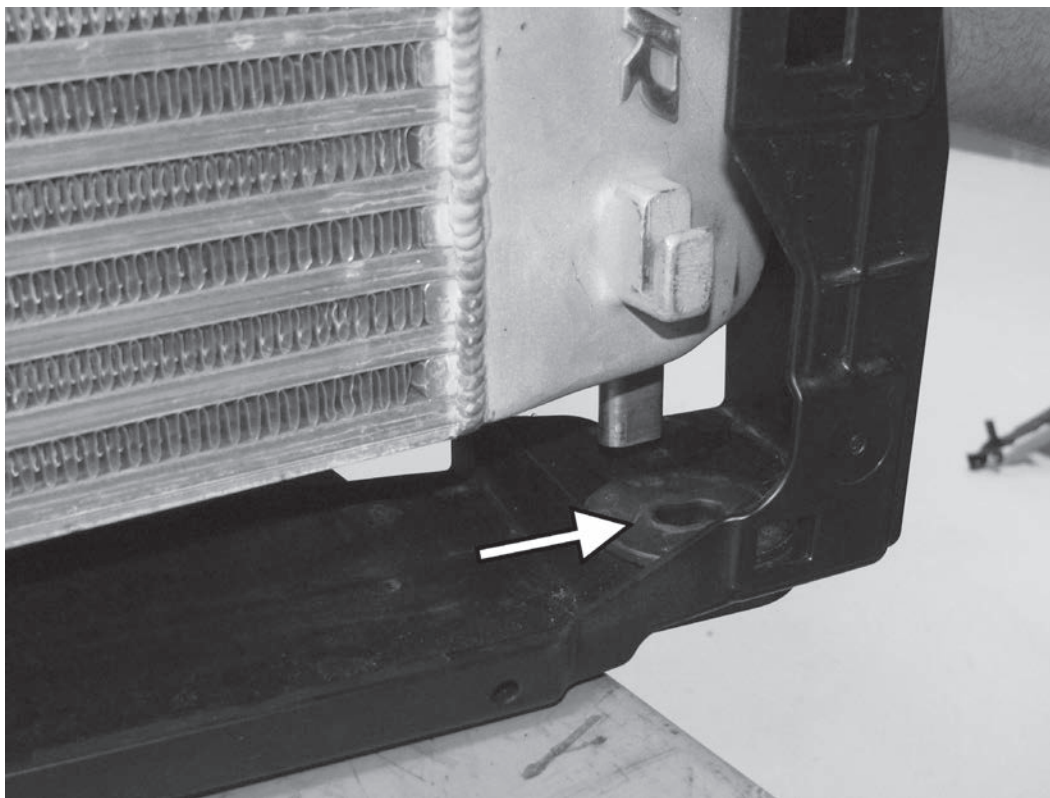

43) Install the core support on the car by first lowering the lower posts on the APR intercooler into the grommeted mounts of the core support.

44) Swing the A/C condenser into place. Lower both bottom mounting tabs of the condenser into the machined slots of the APR intercooler. Then, push the top mounting tabs of the condenser back onto the mounting slots of the intercooler, and secure with the two supplied 5mm allen screws.

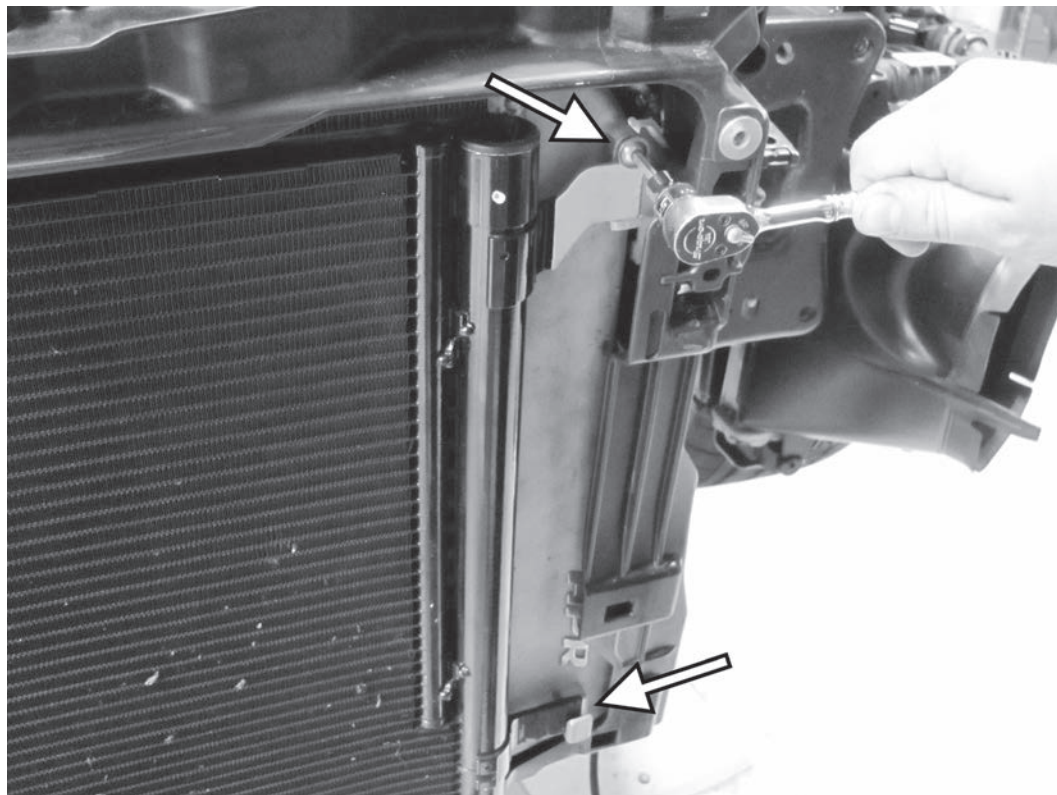

APR, LLC

4800 US HWY 280 West Opelika Alabama 36801

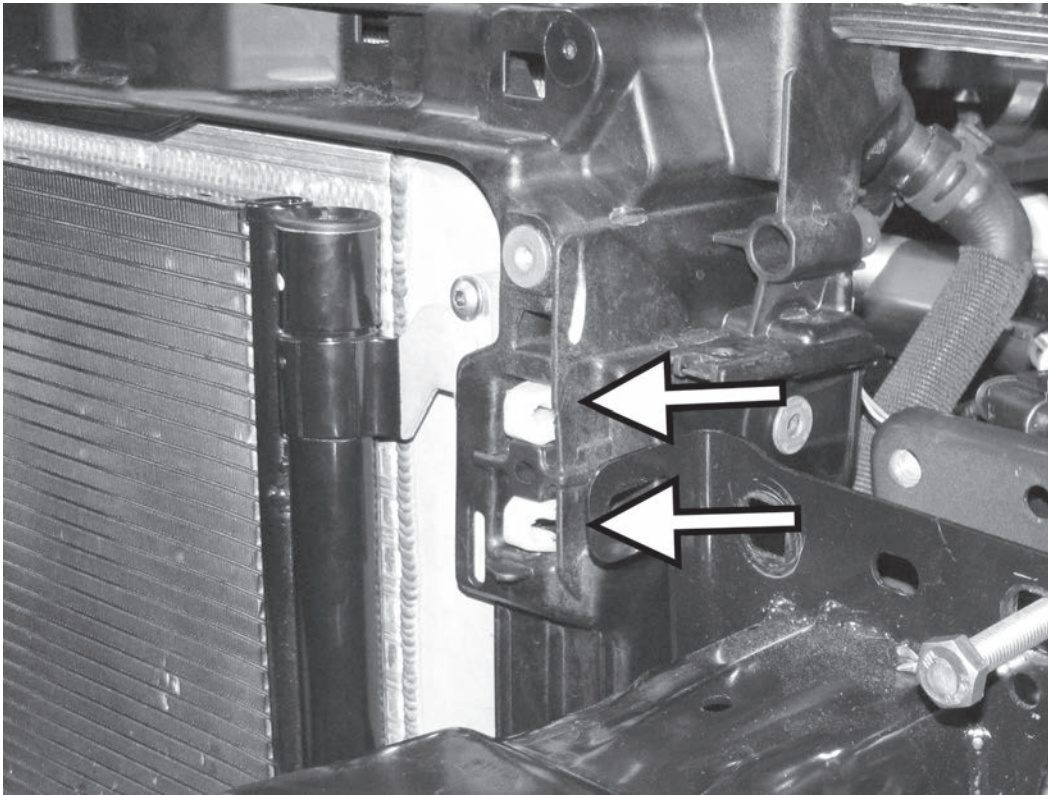

45) Rotate the top of the core support back, so that the intercooler clips slide into the slots of the core support. Once the intercooler is fully in place, make sure the intercooler clips are locked onto the core support by using a screwdriver to pull them forward.

46) Reconnect the electrical connector to the hood latch on the right side of the radiator core support. On the yellow crash sensor, reconnect the electrical connector, then push the locking tab into the connector. Then, locate and reconnect the crash sensor on the left side of the core support.

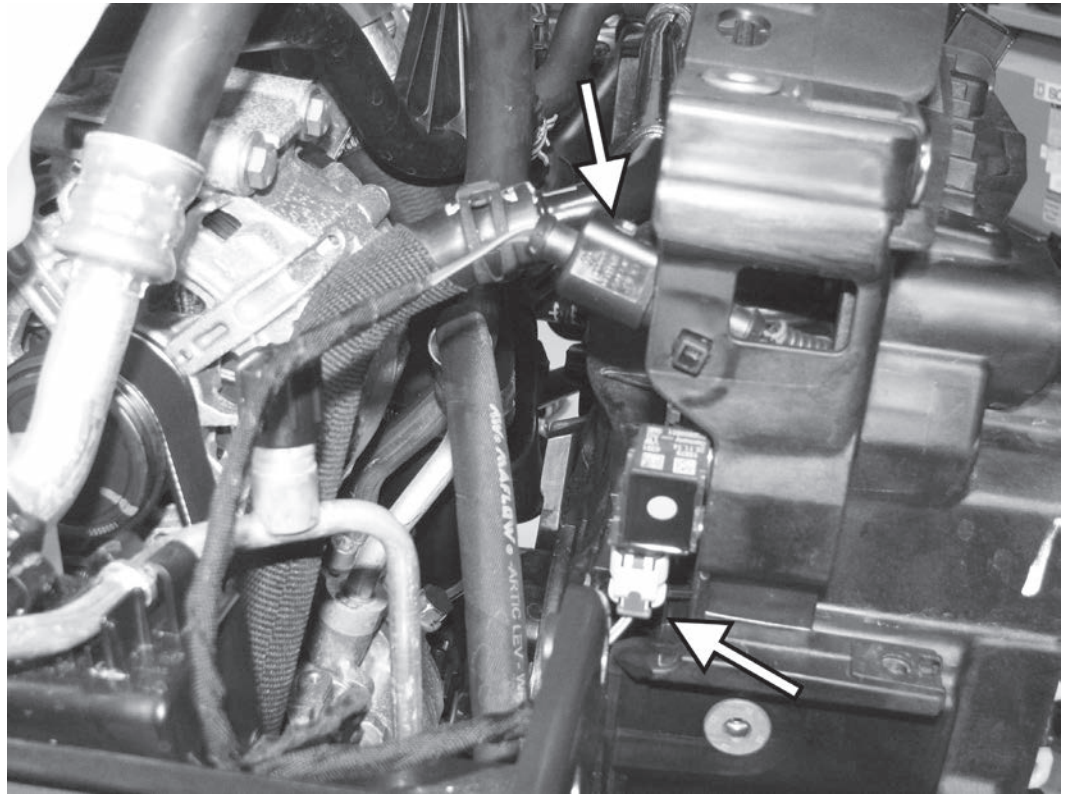

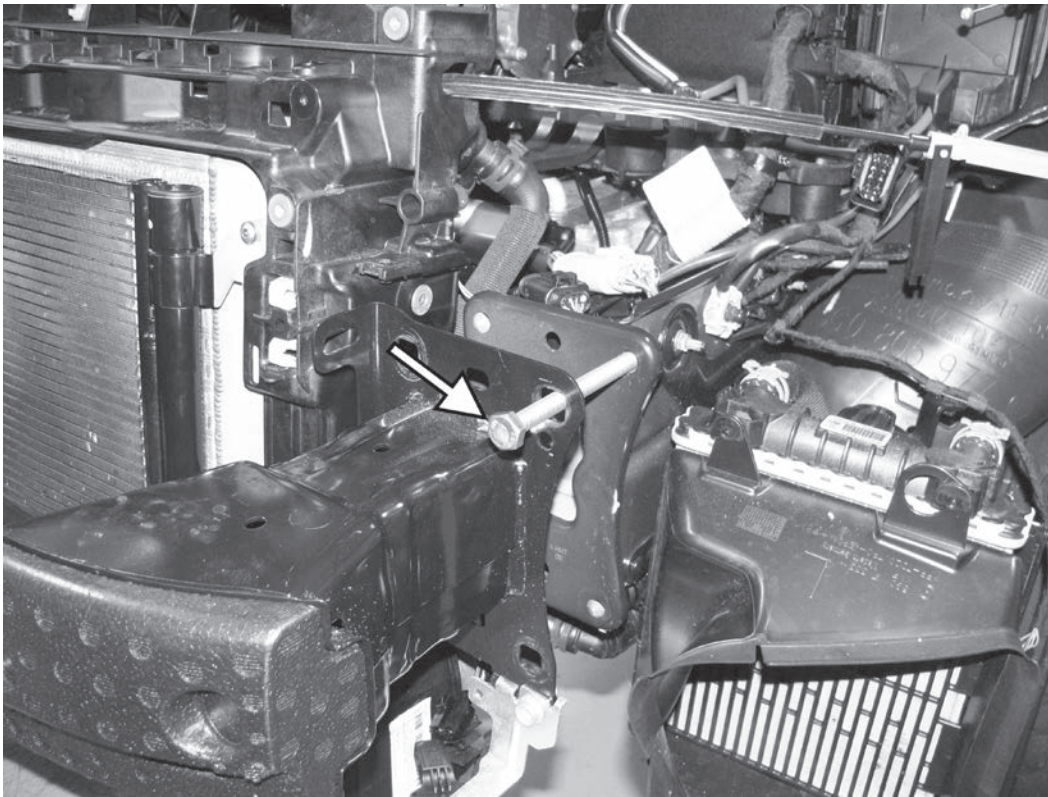

47) Reinstall the factory crash beam using the APR supplied bolts in the upper, outer bolt holes of the main mounting locations.

48) Loosely install the six 16mm bolts (three on each side) to the other open holes of the main mounting location.

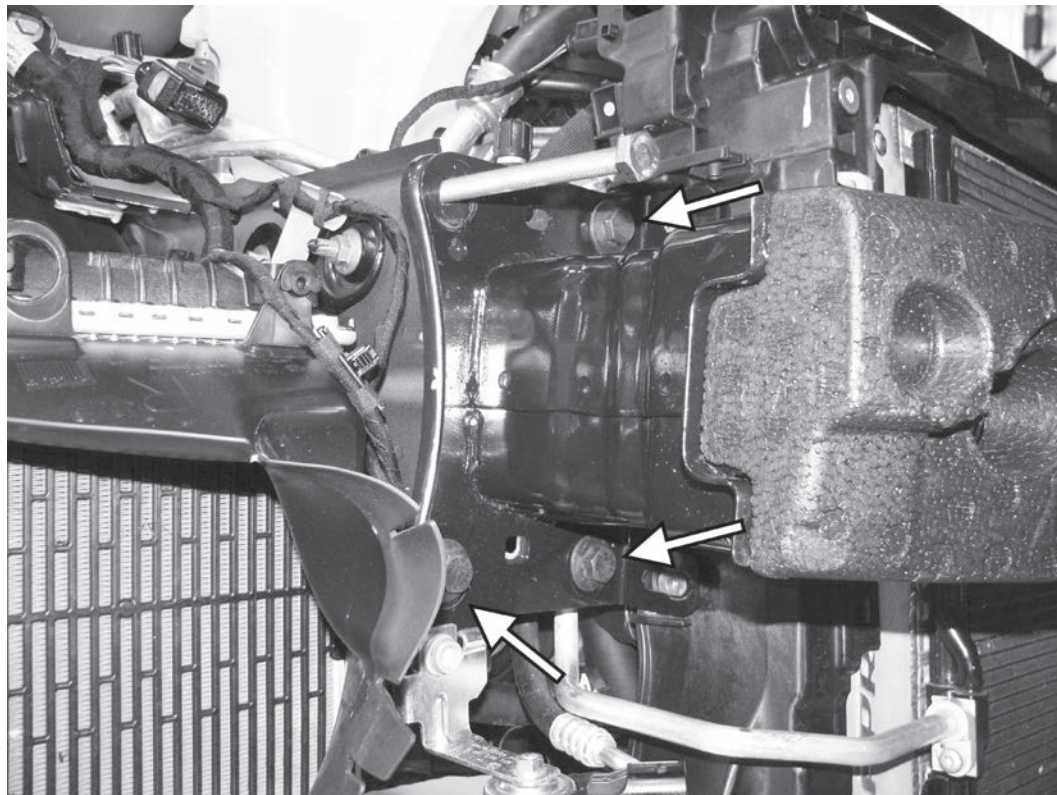

APR, LLC

4800 US HWY 280 West Opelika Alabama 36801

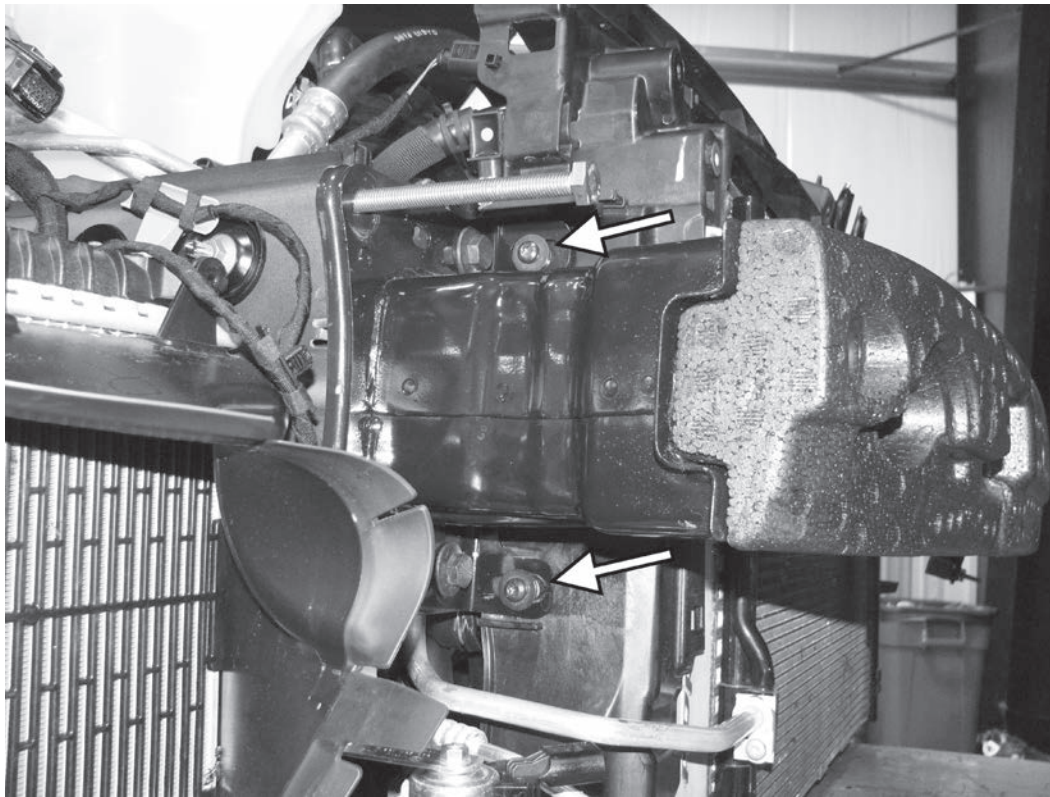

49) Loosely install the four T30 screws (two on each side) connecting the sides of the crash beam bracket to the sides of the core support.

50) Install the two T30 screws connecting the top of the crash beam bracket to the top of the core support. Once these top screws are tight, fully tighten the four T30 side screws of the crash beam.

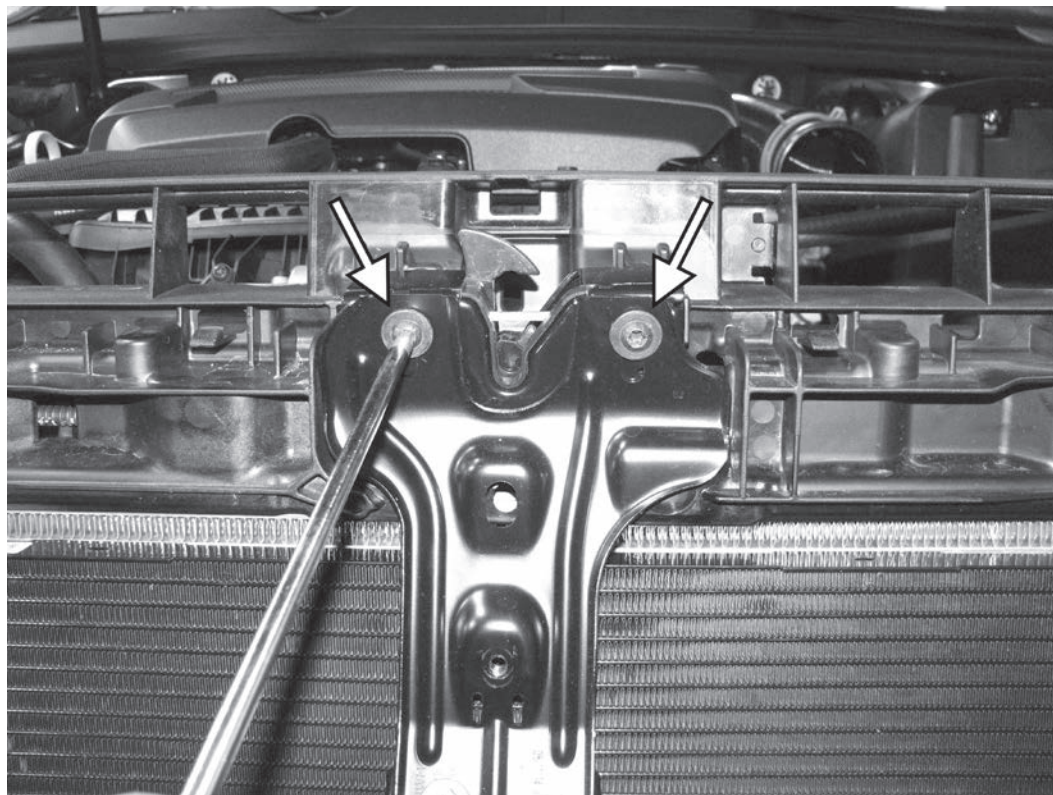

APR, LLC

4800 US HWY 280 West Opelika Alabama 36801

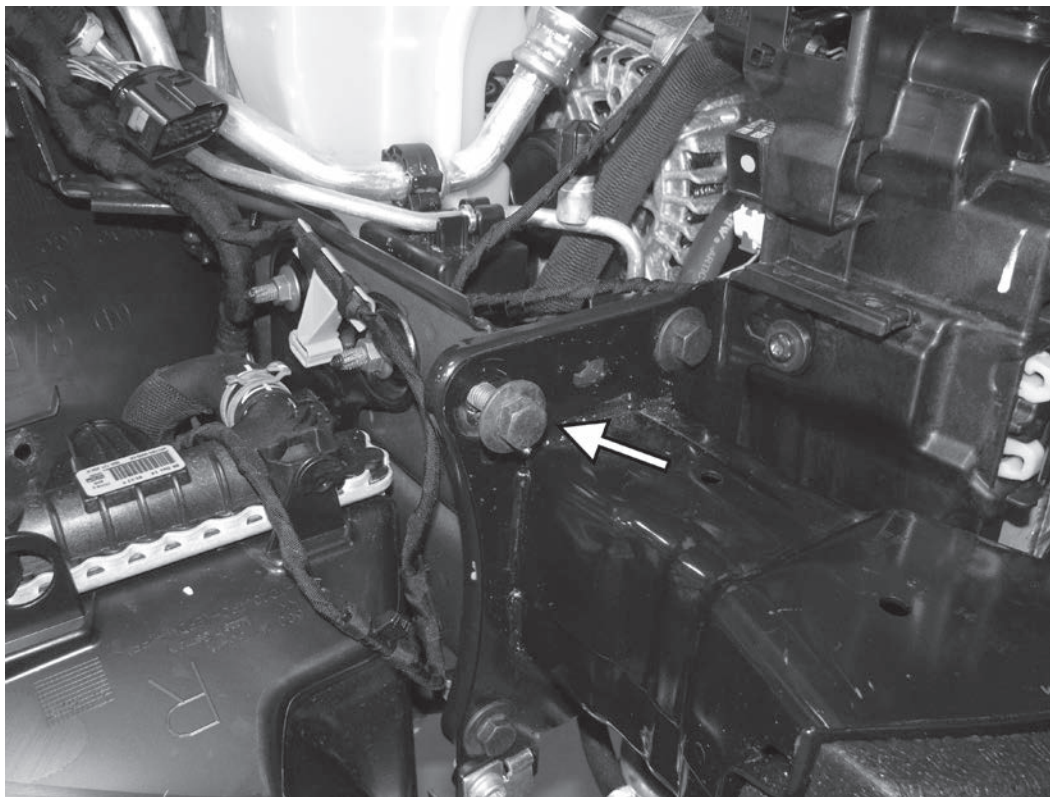

51) Fully tighten the six 16mm main crash beam bolts. Remove the APR supplied long mounting bolts and install the remaining two 16mm bolts. Fully tighten these last remaining bolts.

52) Reinstall both of the radiator air guides to both sides of the core support, making sure they snap into the six original mounting holes (three on each side).

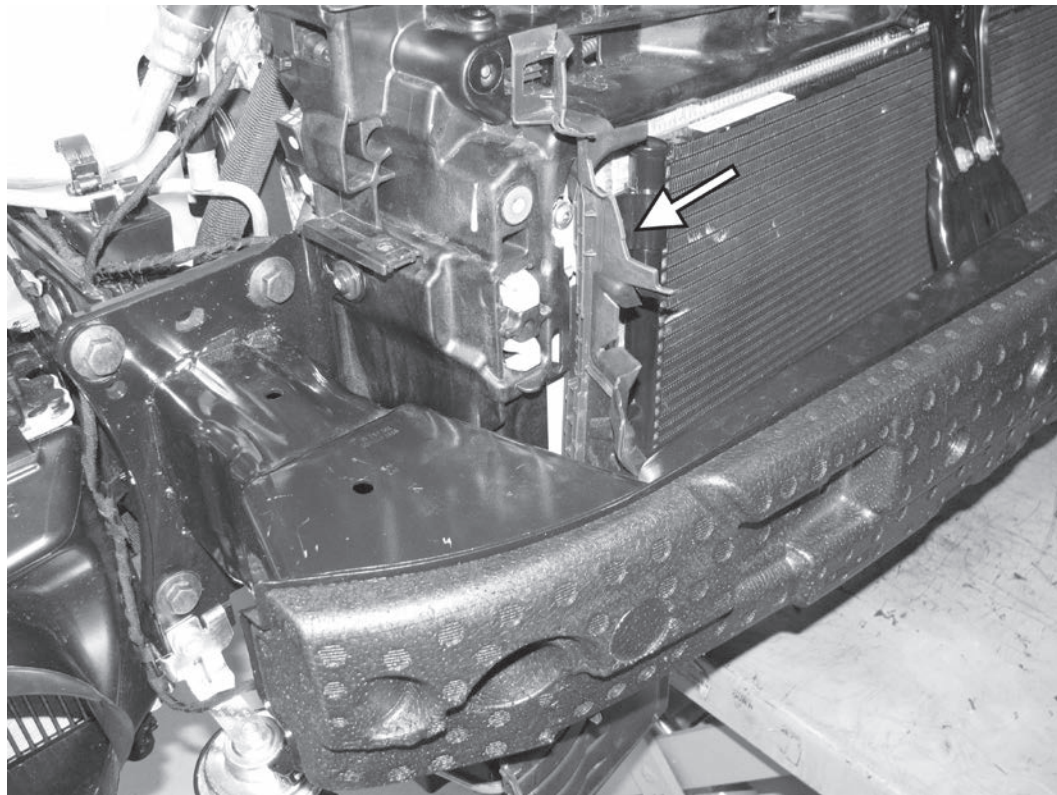

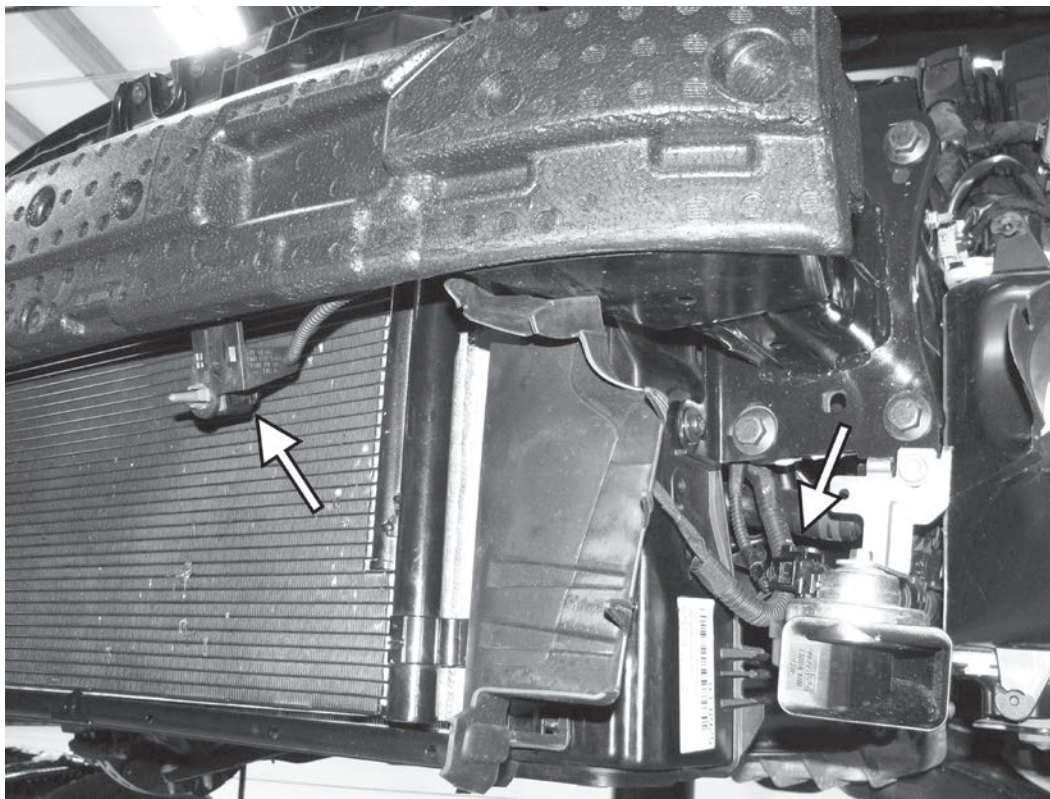

53) Reroute the wiring harness to the outside air temperature sensor, and reconnect the electrical connector. Reconnect the electrical connectors to both horns, on either side of the core support.

54) Slide the headlights back onto their mounting brackets. Reconnect the electrical connector to the headlights, then make sure the rear headlight mounting tab slides around the rear mounting screw that was left in the car.





55) Reinstall the T30 screws on the outside of both headlights.

56) With an assistant, place the factory bumper cover back on the car, being sure to connect the parking sensor electrical connector, if equipped.

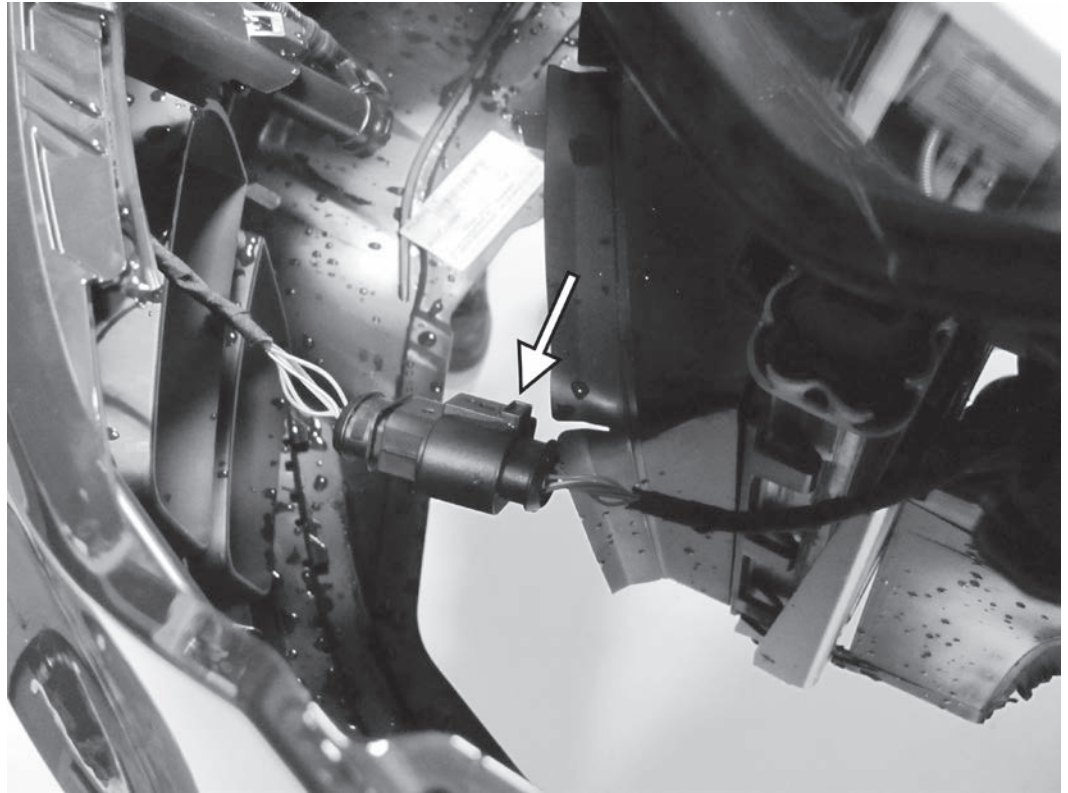

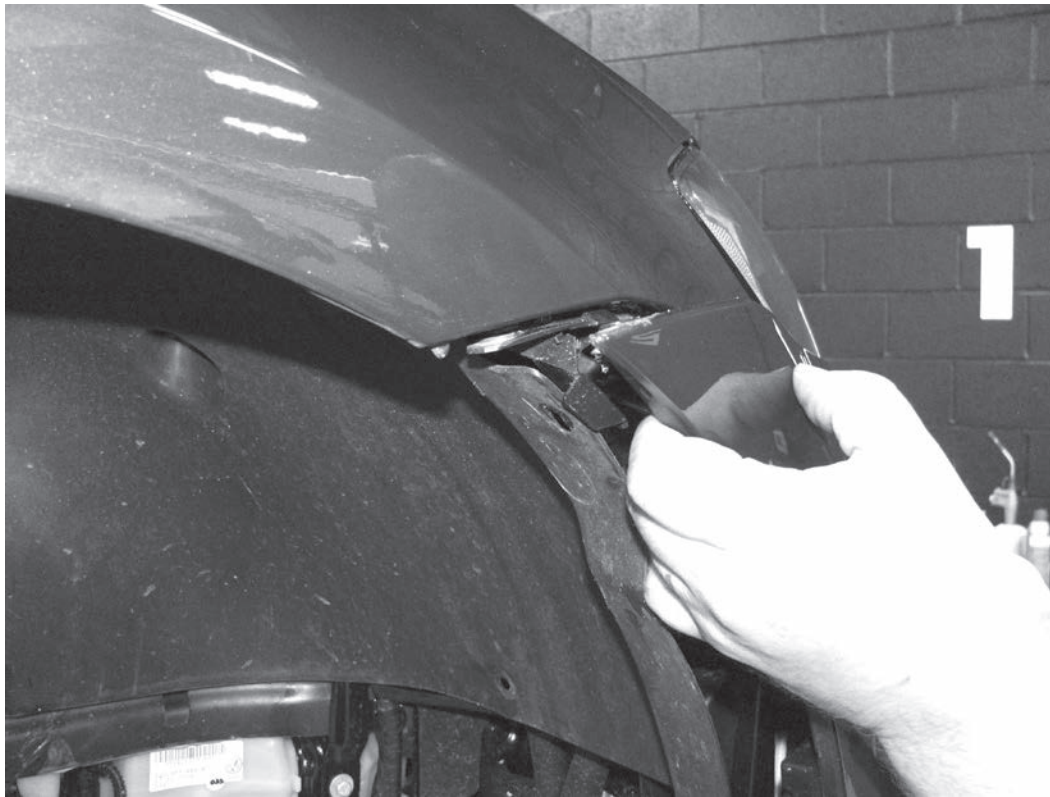

57) Pull the sides of the bumper cover back and snap into the mounting clips on both sides of the front fenders.

58) Remove the APR rubber cap from the windshield washer pump, and reconnect the hose from the headlight washers. Rotate the pump back in place, and remount it the hose to the clips on the bottom of the tank.

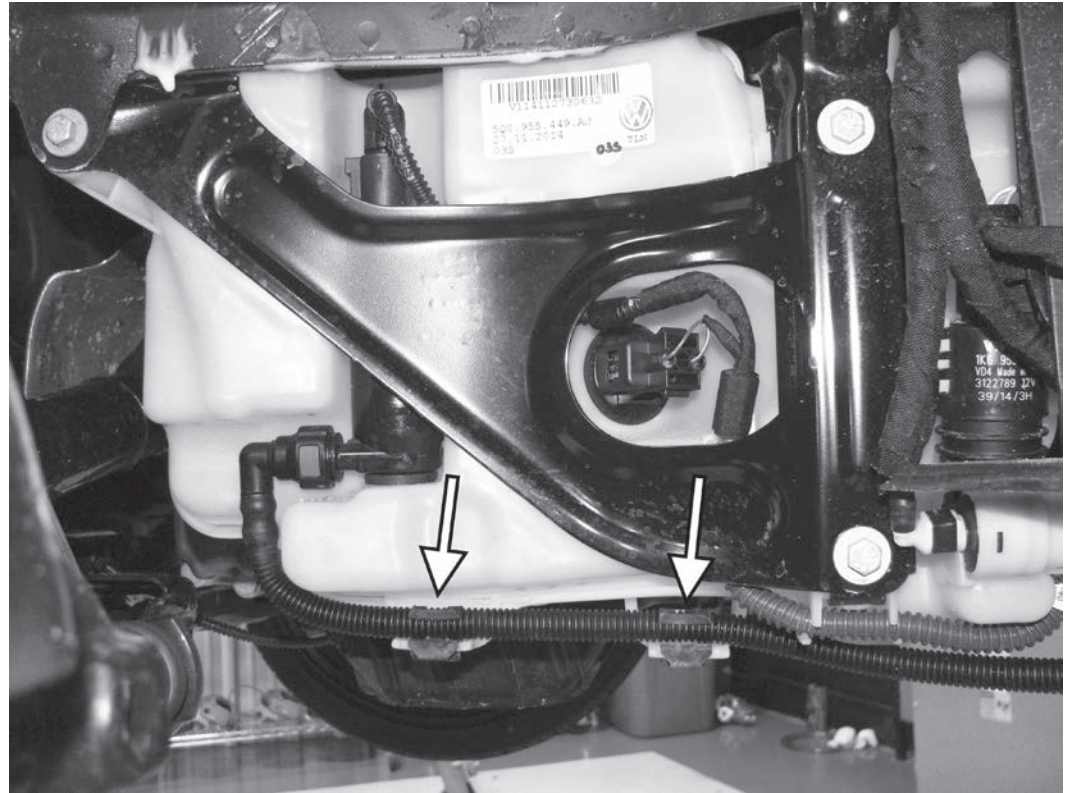



59) Pull back the fender liner, and install the one T25 screw that holds the corner of the bumper cover to the front fender. Repeat on the opposite side.

60) Reinstall the lower fender liner, as well as the five T25 screws that hold the the fender liner inside the wheel well in place.

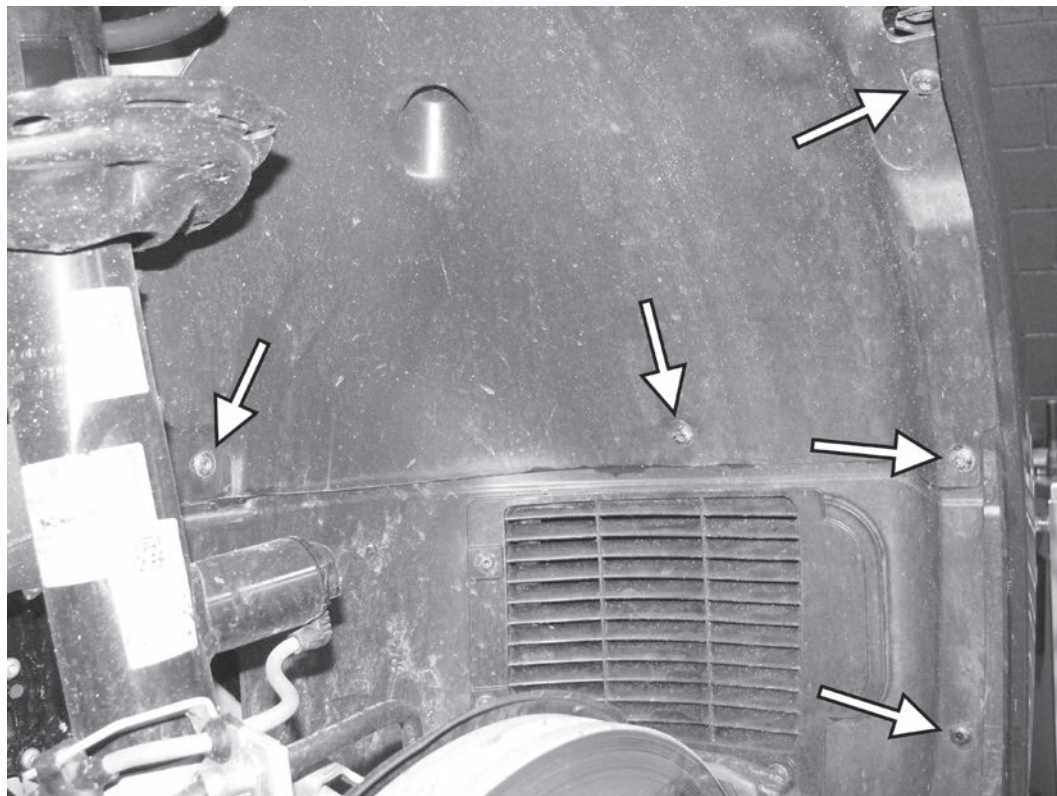

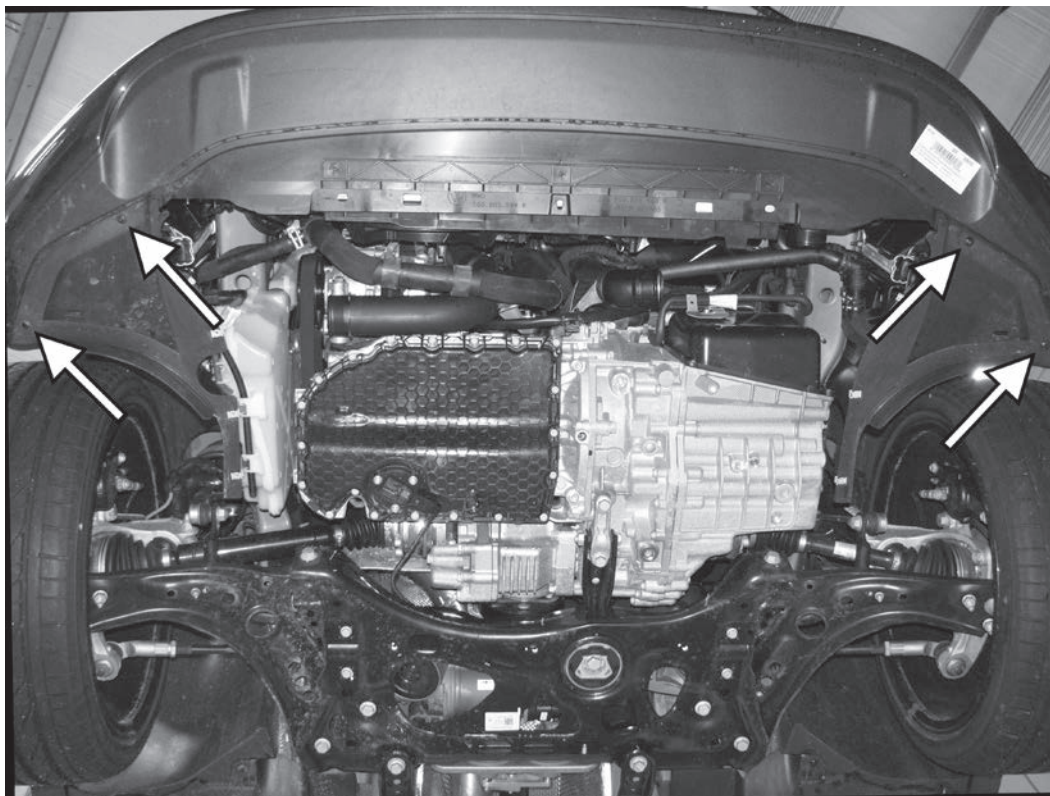

61) Reinstall the four T5 screws that hold the bottom of the fender liners to the bottom of the bumper cover.

62) Reinstall the two intercooler hoses, and secure to the car with hose clamps. The APR intercooler will work with both APR intercooler hoses, as well as stock intercooler hoses.

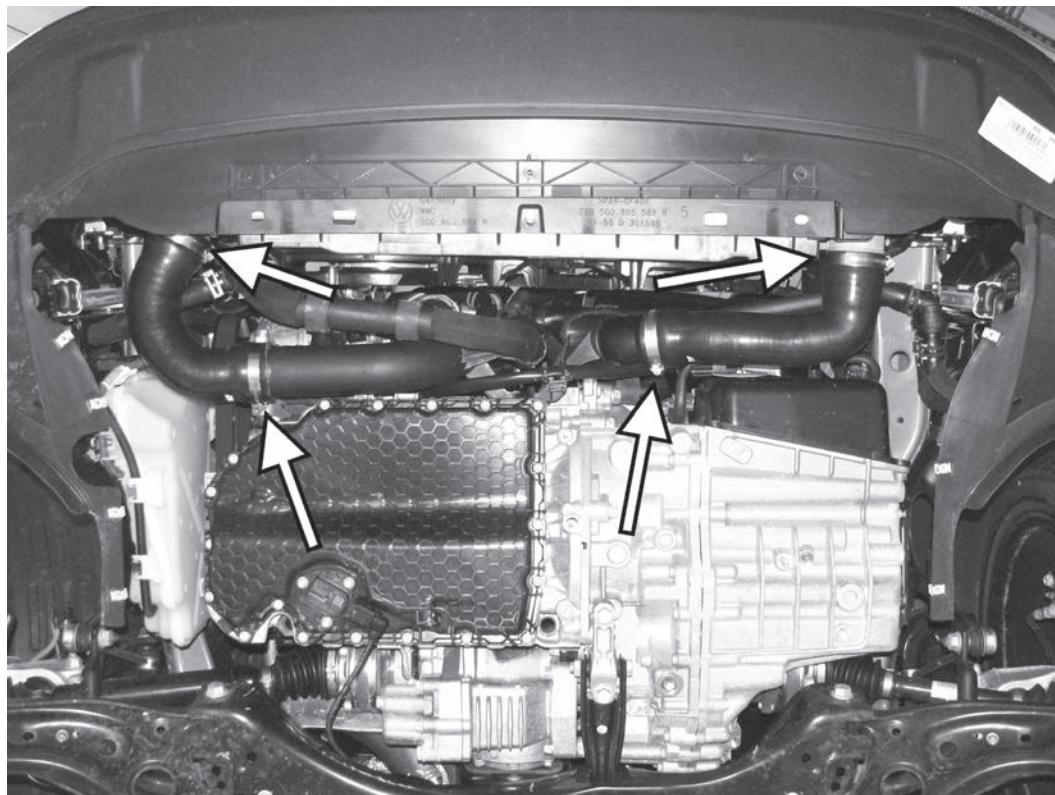

APR, LLC

4800 US HWY 280 West Opelika Alabama 36801

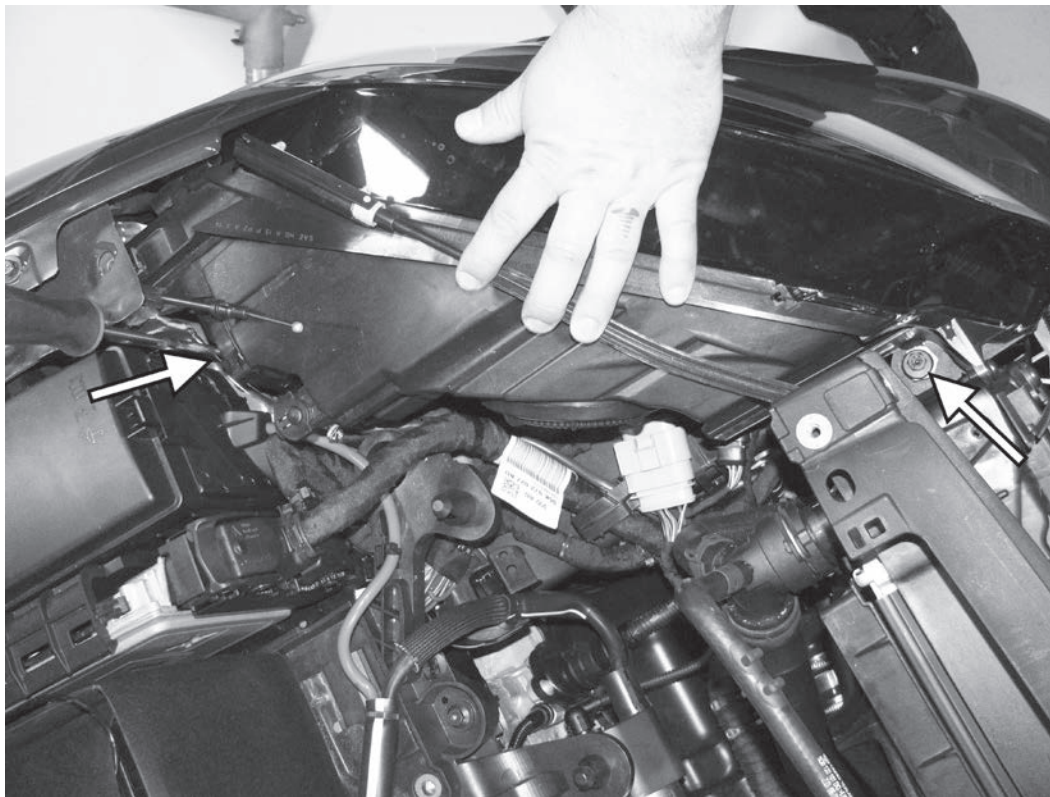

63) Install the T30 screw from the front of both headlight assemblies. Tighten the T30 screws from the rear, lower part of both headlight assemblies.

64) Install the upper core support brackets on the car, and install the six T30 screws holding them in place. Remember that the rear bolts are longer, and mount the rear of the headlights.

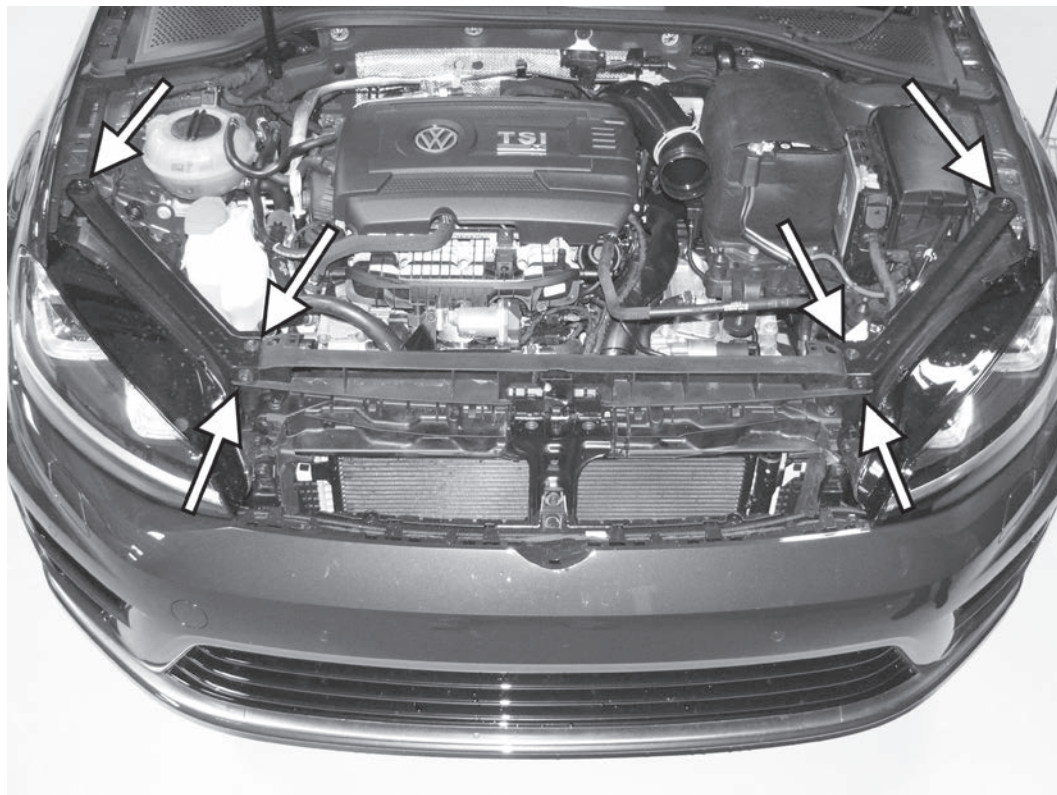



65) Reconnect the hood latch cable by hooking the ball end of the cable to the joint inside of the cable. Then pull the cable apart to reseat the end of the cable in the joint. Close the plastic cover over the joint, and reattach the joint to the upper core support bracket.

66) Reinstall the two T25 screws from the top of the bumper cover.

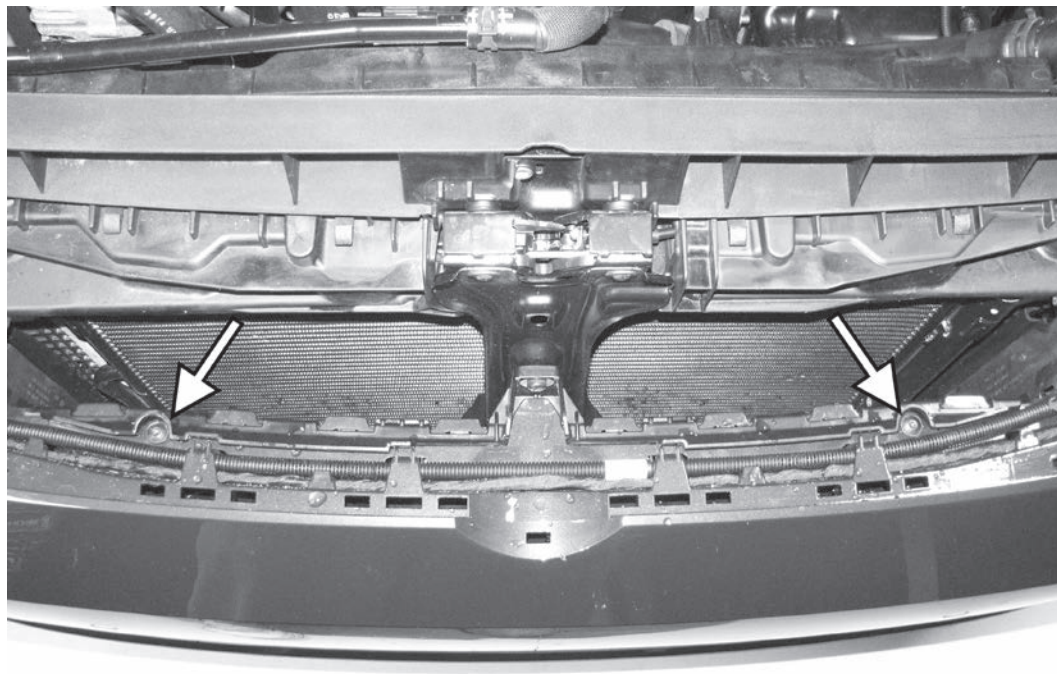

APR, LLC

4800 US HWY 280 West Opelika Alabama 36801

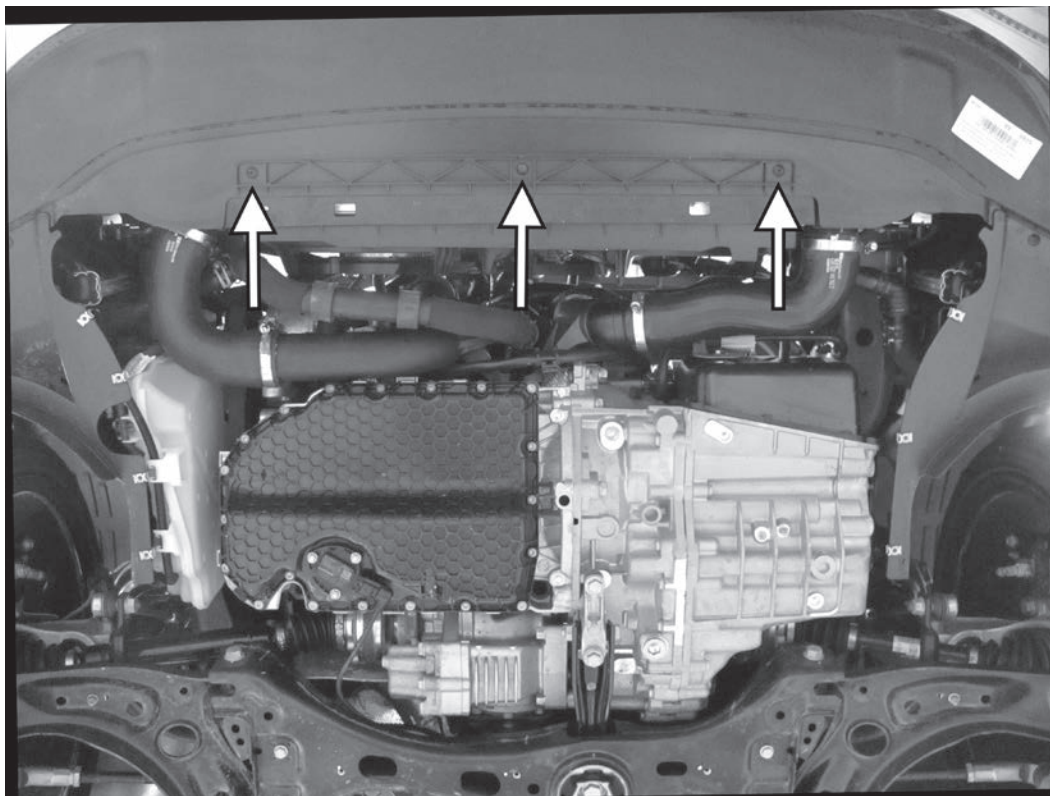

67) Reinstall the three T25 screws that hold the bottom side of the bumper cover to the bottom of the core support.

68) Reinstall the engine belly pan with the eight T25 screws.

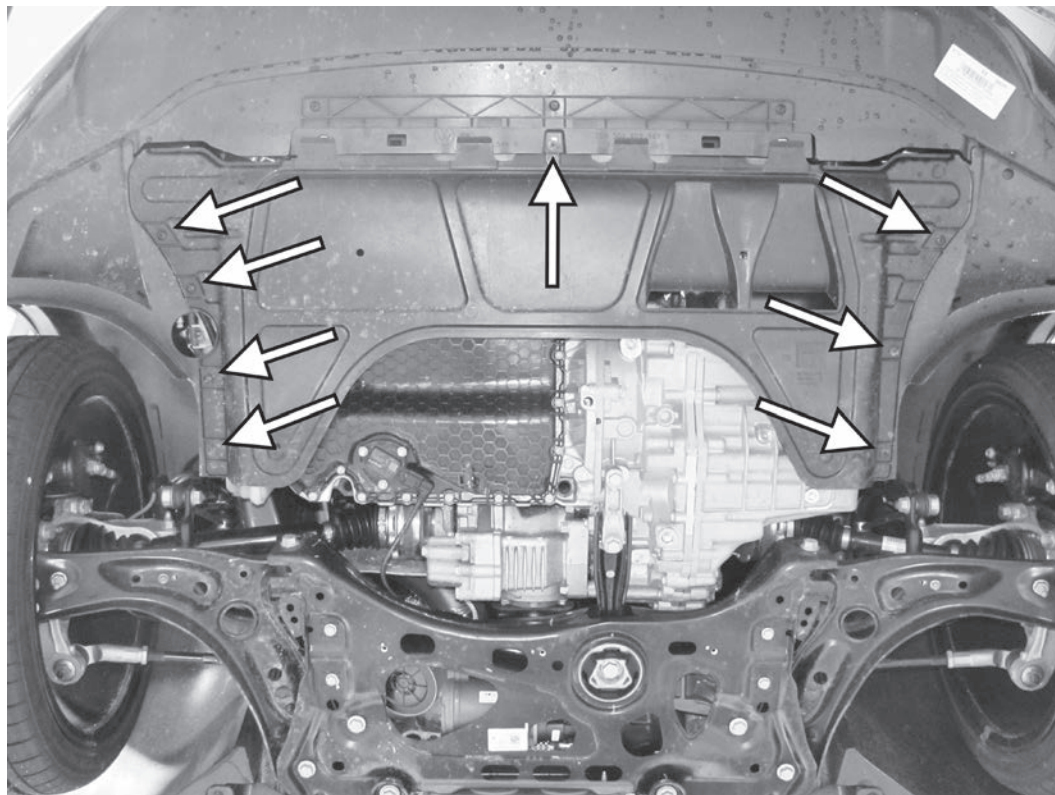

APR, LLC

4800 US HWY 280 West Opelika Alabama 36801

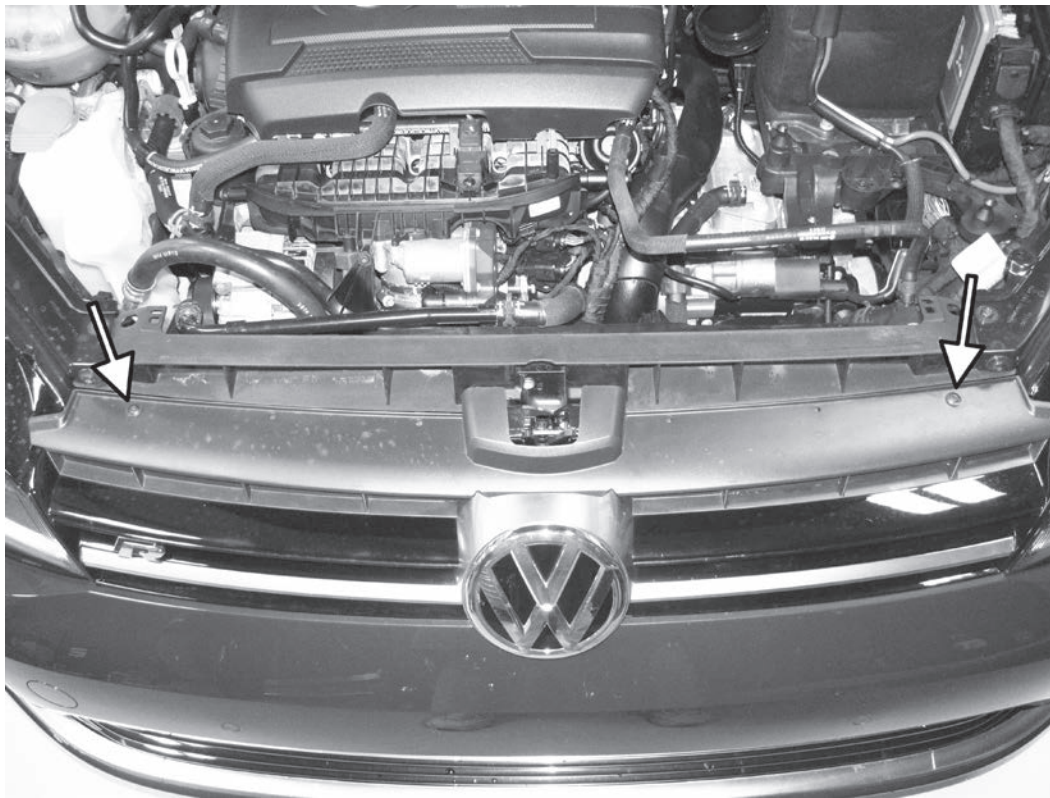

69) Reinstall the front grill by sliding it back in place and then securing it with the two T25 screws.

70) Reinstall the intake in the car. Be sure to connect the vacuum line to the bottom of the intake before fully placing it in the car. Secure the stock inlet tube to the back of the intake with the large spring clamp. Finally, install the front of the intake to the tab on the core support and secure with the T25 screw.

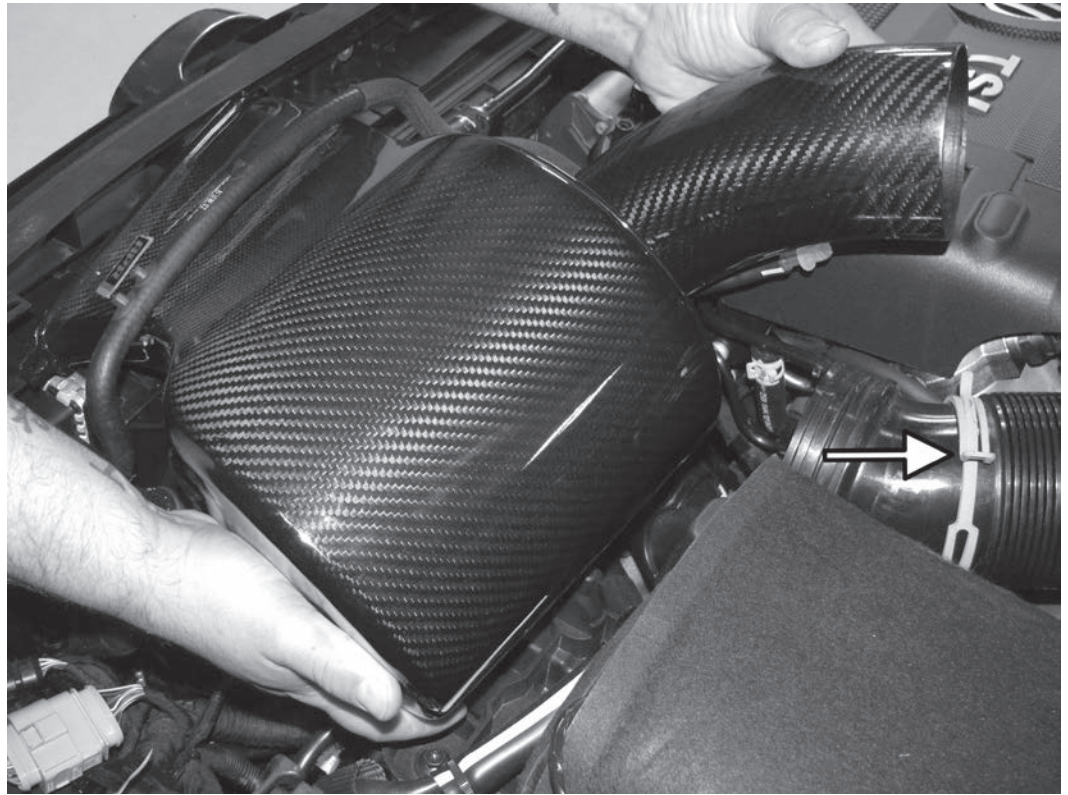

#TL10044

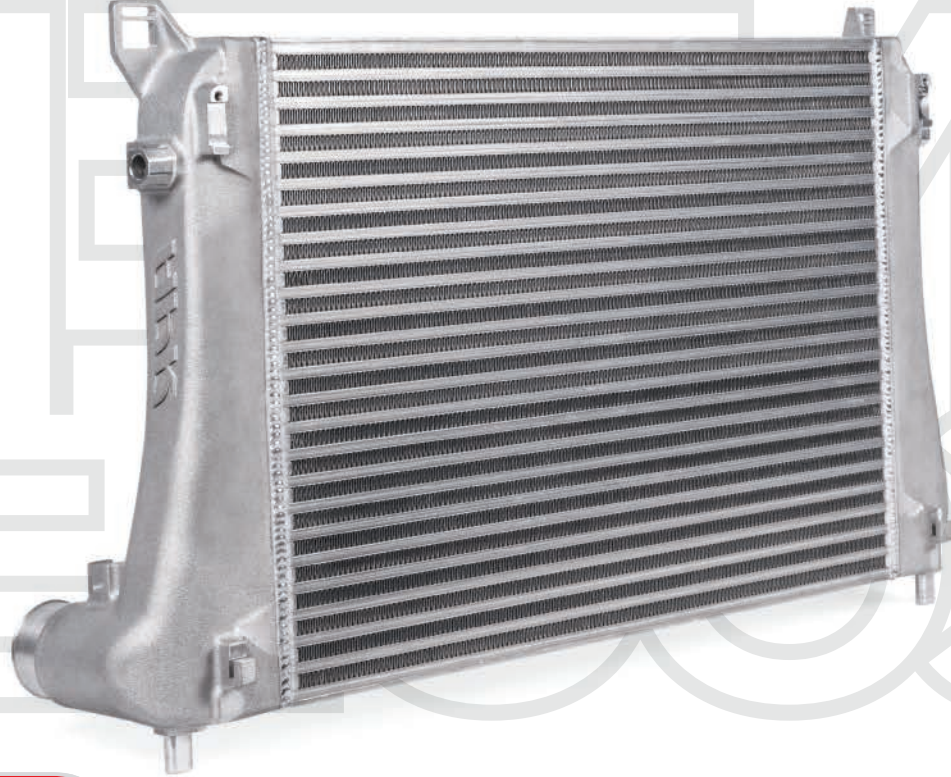

APR

MOB 1.8T/2.0T INTERCOOLER
INSTALLATION INSTRUCTIONS