



GM DSP Interface With Pre-Wired Harness 2012-2017

INTERFACE FEATURES

- Includes a DSP (Digital Signal Processor)
- 31 Band graphic EQ
- 10 individually assignable outputs
- Independent equalization on each of the 10 outputs
- Independent high pass, low pass, and bandpass filters
- Each channel can be delayed independently up to 10ms
- Clipping detection and limiting circuits
- Retains factory parking sensor chimes
- Retains OnStar[®] voice prompts
- Adjustable chime level
- Can be used in amplified and non-amplified models
- Easy behind the radio installation with pre-wired harness
- Bass knob included for level control of subwoofer amp
- Settings adjusted via Bluetooth[®] in a smart device application (tablet or mobile phone), compatible with both Android and Apple devices
- Read, write, and store configurations for future recall
- Password protect feature available in the mobile app
- Micro-B USB updatable

APPLICATIONS

Visit axxessinterfaces.com for current application list

TABLE OF CONTENTS

| | |
|----------------------------|------|
| Installation Options | 2 |
| Installation | 2 |
| Connections | 3-4 |
| Mobile App | 5-13 |
| Specifications | 14 |

INTERFACE COMPONENTS

- AXDSPX-GL44 interface
- AXDSPX-GL44 interface harness
- AXDSPX-GL44 vehicle T-harness • Bass knob

TOOLS & INSTALLATION ACCESSORIES REQUIRED

- Crimping tool and connectors, or solder gun, solder, and heat shrink • Tape • Wire cutter
- Zip ties • Multimeter

Google Play Store



Apple App Store

iOS 12.1 or higher



INSTALLATION OPTIONS

Adding a sub to a factory system:

This feature offers the ability to add a subwoofer to a factory system, whether amplified or non-amplified. (refer to [page 3](#))

Adding a full-range amp & sub to a factory system:

This feature offers the ability to add a full-range amp and sub to a factory system, whether amplified † or non-amplified. (refer to [page 4](#))

† For amplified models the amp must be bypassed/unplugged, and **With OE Amplifier** chosen in the **Configuration** tab under **Vehicle Type**.

Note: The interface provides a 12-volt 1-amp output to turn on aftermarket amp(s). If installing multiple amps, an SPDT automotive relay will be required if the amp turn-on current of all amps combined exceeds 1-amp. Use Metra part number [E-123](#) (sold separately) for best results.

INSTALLATION

1. Remove the factory radio †, then unplug all connectors.
 2. Install the **AX-DSPX-GL44 vehicle T-harness** to the vehicle and make all necessary connections, but leave the amp turn-on wire disconnected.
 3. Plug the **AX-DSPX-GL44 vehicle T-harness** to the **AX-DSPX-GL44 interface**.
 4. Plug the **AX-DSPX-GL44 interface harness** to the **AX-DSPX-GL44 interface**.
 5. Download and install the AXDSP-X app from the **Google Play Store** or **Apple App Store**.
 6. Open the app then select the **Bluetooth Connection** tab. Follow the instructions to pair the mobile device to the interface. Refer to [page 6](#) for more information.
 7. Scroll to the **Configuration** tab then select the vehicle type. Press the **Lock Down ‡** button to save the configuration. Refer to [page 7](#) for more information.
 8. Connect the amp turn-on wire.
 9. Adjust the settings in the app as desired. Press the **Lock Down ‡** button to save any new configurations.
- † Refer to [Metra online](#) for dash disassembly. If Metra makes a dash kit for the vehicle, disassembly will be within those instructions.
- ‡ Anytime the interface is locked down the key must be cycled off then back on

ADDING A SUB TO A FACTORY SYSTEM

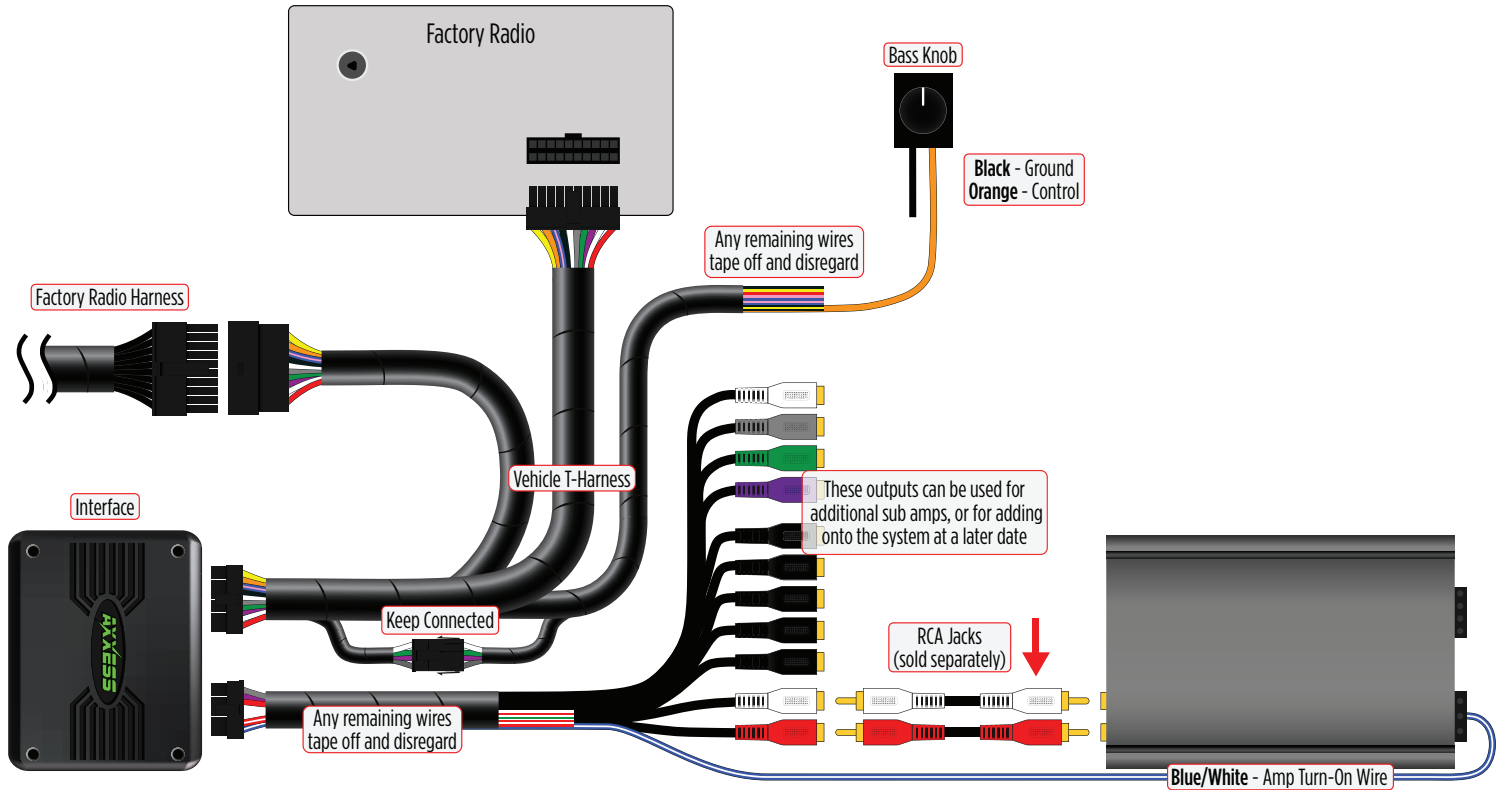

ADDING A FULL-RANGE AMP & SUB TO A FACTORY SYSTEM

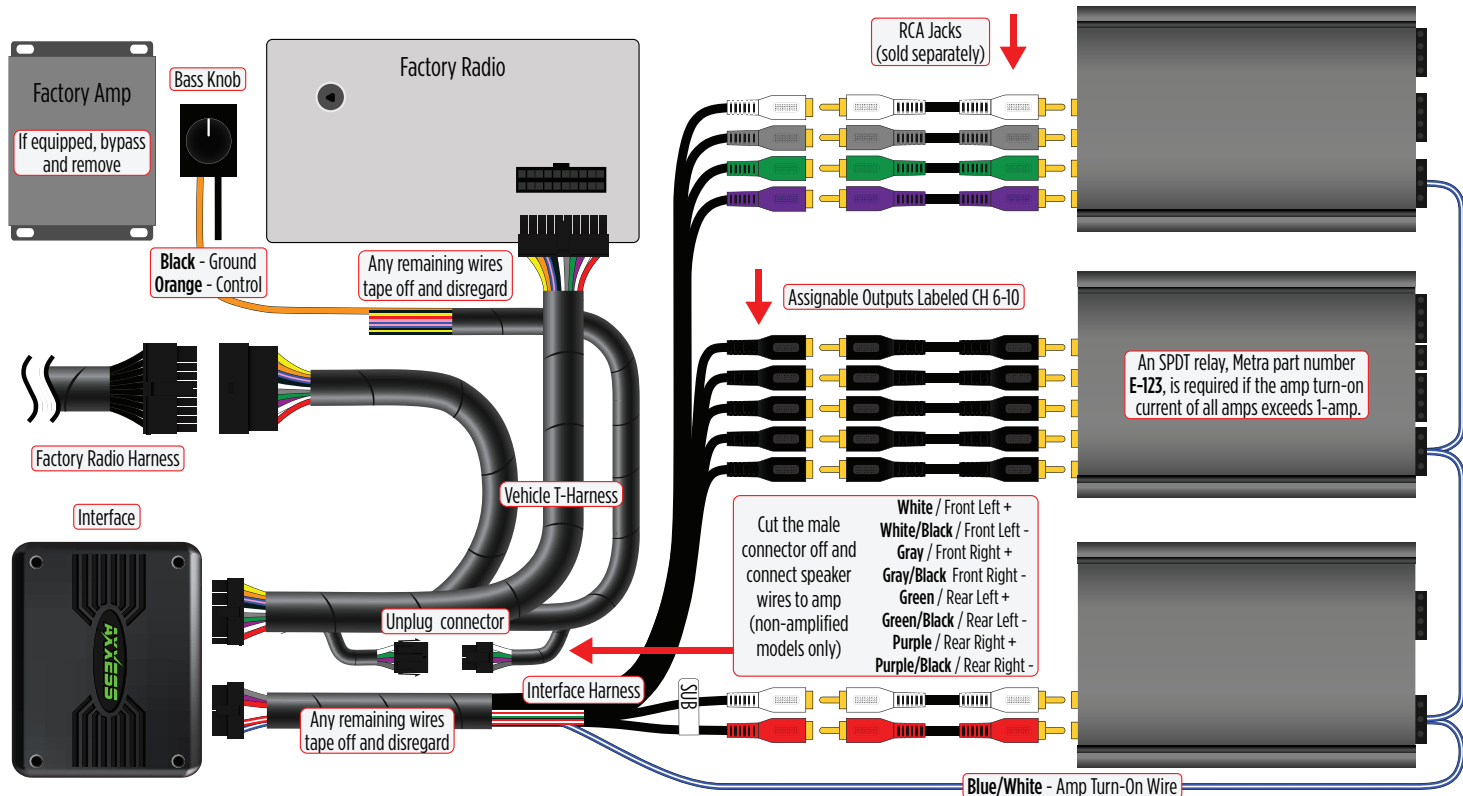

Setup Instructions

| SETUP INSTRUCTIONS | BLUETOOTH CONNECTION | CONFIGURATION | OUTPUTS |
|--------------------|----------------------|---------------|---------------|
| CROSSOVER ADJUST | EQUALIZER ADJUST | DELAY ADJUST | INPUTS/LEVELS |

Using the vehicle specific harness, install the AX-DSP. The high level outputs from the OEM radio go to the inputs of the AX-DSP. The AX-DSP outputs are low level and should be connected to the amplifier inputs.

- Power on the system, and verify audio to the front (left and right), rear (left and right), and Subwoofer.
- Set the OEM radio bass and treble controls for flat frequency response.
- Set the left/right balance to center.
- Set the front/rear fader to center.

Detailed installation instructions are available on-line. Click the button below to view the instructions

[VIEW INSTRUCTIONS](#)

- General information tab for installing the interface.

Continued on the next page

Bluetooth Connection

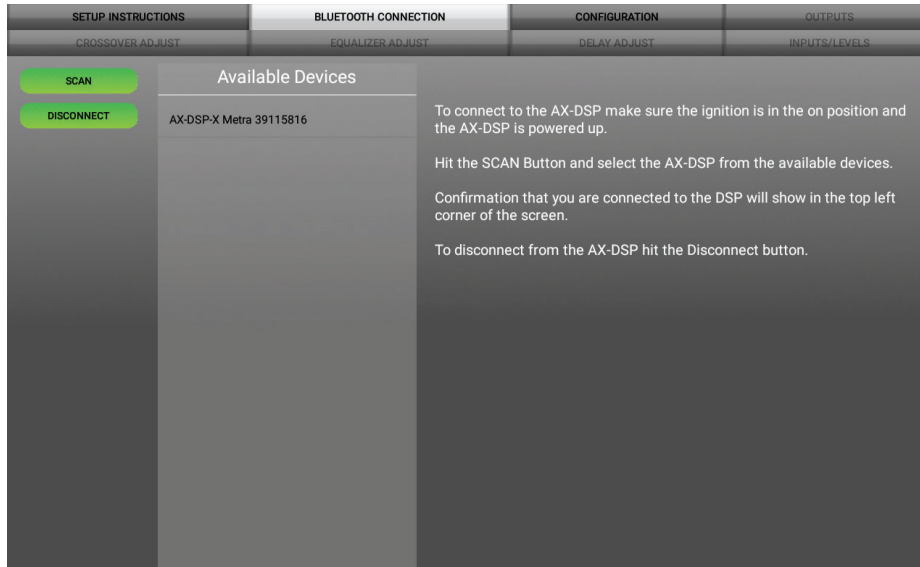

- **Scan** - Press this button to start the Bluetooth pairing process, then select the interface once it is found. "Connected" will appear in the top left corner of the app once paired.
- **Disconnect** - Disconnects the interface from the app.

Note: The ignition must be cycled on during this process.

Continued on the next page

Configuration

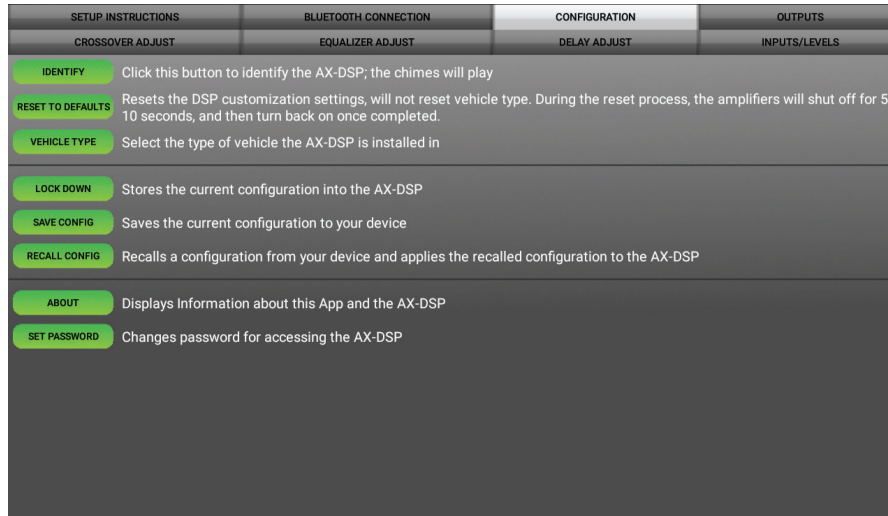

- **Identify** - Click this button to send a test tone to the front left speaker*.
* Only installations using the front left output (white RCA jack).
- **Reset to Defaults** - Resets the interface to factory settings. During the reset process the amp(s) will shut off for 5-10 seconds.
- **Vehicle Type** - Select the vehicle type from the drop down box, then click the apply button.
- **Lock Down** - Click this button to save the selected settings.
Attention! This must be done before closing the app or cycling the key otherwise all new changes will be lost!

- **Save Configuration** - Saves the current configuration to the mobile device.
- **Recall Configuration** - Recalls a configuration from the mobile device.
- **About** - Displays information about the app, vehicle, interface, and mobile device.
- **Set Password** - Assign a 4-digit password to lock the interface. If no password is desired, use "0000". This will clear out any currently set password. It is not necessary to lock down the interface when setting a password.
Note: A 4-digit only password must be chosen otherwise the interface will show "password not valid for this device".

Continued on the next page

Outputs

| SETUP INSTRUCTIONS | | BLUETOOTH CONNECTION | | CONFIGURATION | | OUTPUTS | |
|------------------------|-------------|----------------------|---------------------------------|-------------------------------|--|---------------|--|
| CROSSOVER ADJUST | | EQUALIZER ADJUST | | DELAY ADJUST | | INPUTS/LEVELS | |
| <u>Output Channels</u> | | | | | | | |
| # | Location | Group | | | | | |
| 1 | Left Front | None | <input type="checkbox"/> Invert | <input type="checkbox"/> Mute | | | |
| 2 | Right Front | None | <input type="checkbox"/> Invert | <input type="checkbox"/> Mute | | | |
| 3 | Left Rear | None | <input type="checkbox"/> Invert | <input type="checkbox"/> Mute | | | |
| 4 | Right Rear | None | <input type="checkbox"/> Invert | <input type="checkbox"/> Mute | | | |
| 5 | Sub Woofer | None | <input type="checkbox"/> Invert | <input type="checkbox"/> Mute | | | |
| 6 | Not Used | None | <input type="checkbox"/> Invert | <input type="checkbox"/> Mute | | | |
| 7 | Not Used | None | <input type="checkbox"/> Invert | <input type="checkbox"/> Mute | | | |
| 8 | Not Used | None | <input type="checkbox"/> Invert | <input type="checkbox"/> Mute | | | |
| 9 | Not Used | None | <input type="checkbox"/> Invert | <input type="checkbox"/> Mute | | | |
| 10 | Not Used | None | <input type="checkbox"/> Invert | <input type="checkbox"/> Mute | | | |

Output Channels

- **Location** - Location of speaker.
- **Group** - Used to join channels together for simple equalization. Example, left front woofer/midrange and left front tweeter will be considered simply left front. The letter **M** indicates the speaker assigned as the master speaker.
- **Invert** - Will invert the phase of the speaker.
- **Mute** - Will mute desired channel(s) for tuning individual channels.

Continued on the next page

Crossover Adjust



- If installing a subwoofer, the front and rear outputs will default to a 100Hz high pass filter to keep the low frequency signals out. If a subwoofer is not being installed, change the front and rear crossover points down to 20Hz for a full range signal, or to the lowest frequency the speakers will play down to.
- Selecting **High Pass** and **Low Pass** will provide one crossover frequency adjustment. Selecting **Band Pass** will provide two crossover frequency adjustments, one for low pass, and one for high pass.

Continued on the next page

Equalizer Adjust

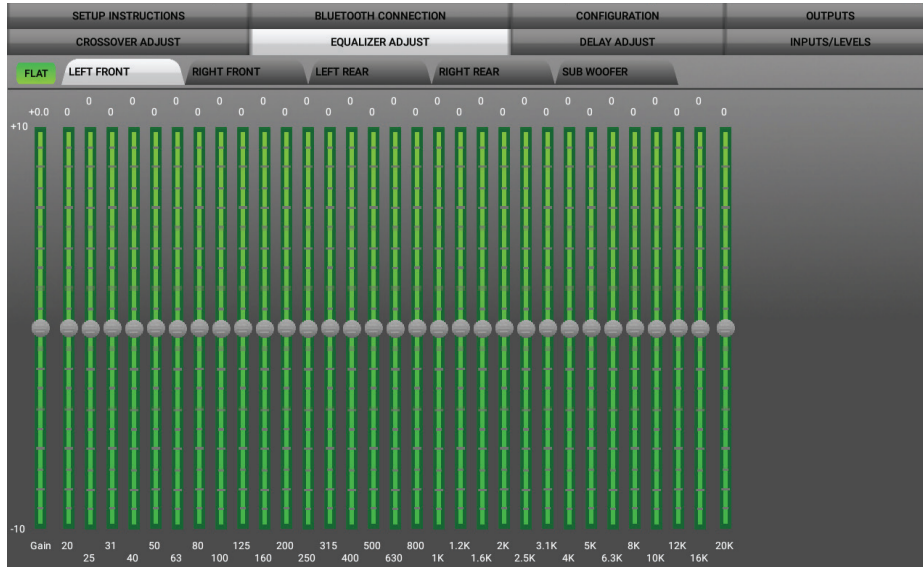

- All channels can be adjusted independently within this tab with 31 bands of available equalization. It is best to tune this by using an RTA (Real Time Analyzer).
- The **Gain** slider on the far left is for the channel selected.

Continued on the next page

Delay Adjust

| SETUP INSTRUCTIONS | BLUETOOTH CONNECTION | CONFIGURATION | OUTPUTS |
|--------------------|----------------------|---------------|---------------|
| CROSSOVER ADJUST | EQUALIZER ADJUST | DELAY ADJUST | INPUTS/LEVELS |

Distance from each speaker to 'Head' position (in inches)

| | |
|-------------|---|
| Left Front | 0 |
| Right Front | 0 |
| Left Rear | 0 |
| Right Rear | 0 |
| Sub Woofer | 0 |

Measure the distance from each speaker to the desired 'Head' position and enter those values in the corresponding boxes. Maximum distance is 99".

- Allows a delay of each channel. If a delay is desired, first measure the distance (in inches) from each speaker to the listening position, then enter those values to the corresponding speaker. Add (in inches) to the desired speaker to delay it.

Continued on the next page

Inputs/Levels

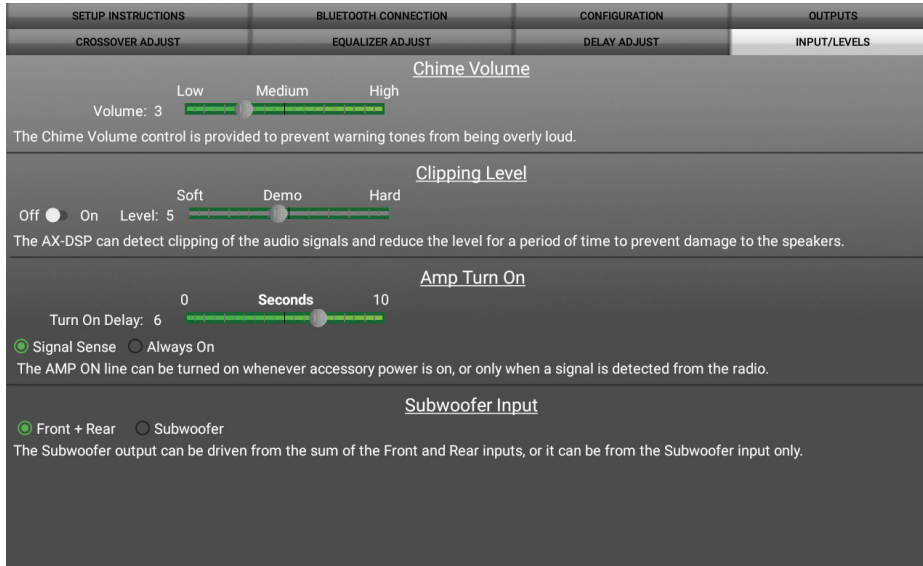

- **Chime Volume** - Allows the chime volume to be adjusted up or down.
- **Clipping Level** - Use this feature to protect sensitive speakers like tweeters from being driven past their capabilities. If the output signal of the interface clips the audio will be reduced by 20dB. Turning down the stereo will allow the audio to come back at a normal level. The sensitivity of this feature can be adjusted to the listening preference of the user.
- **Amp Turn On**
 - **Signal Sense** - Will turn the amp(s) on when an audio signal is detected, and keep on for 10 seconds after the last signal. This ensures the amp(s) won't shut off between tracks.
 - **Always On** - Will keep the amp(s) on as long as the ignition is cycled on.
 - **Turn on Delay** - Can be used to delay audio output to avoid turn-on pops.
- **Subwoofer Input** - Select **Front + Rear**

Continued on the next page

Locking Down Data

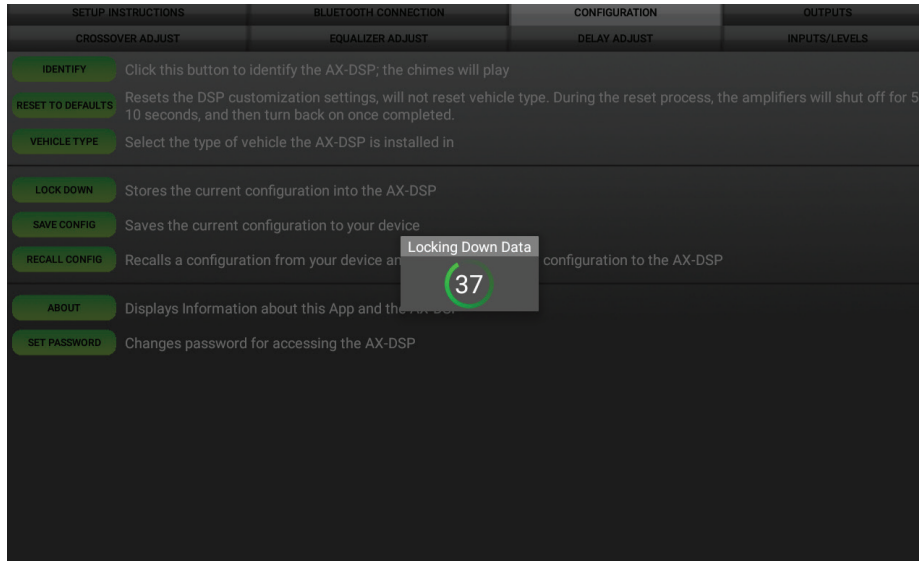

**Last and the most important.
You must lock down your
configuration and cycle the key!!!**

SPECIFICATIONS

| | |
|-------------------------------------|-------------------------------------|
| Input Impedance | 1M Ohm |
| Input Channels | 6 |
| Input Options | High Level or Low Level |
| Input Type | Differential balanced |
| Input Voltage (high level range) | 0 - 28-volts (peak-to-peak) |
| Input Voltage (low level range) | 0 - 4.9-volts (peak-to-peak) |
| Output Channels | 10 |
| Output Voltage | Up to 5-volts RMS |
| Output Impedance | 50 Ohms |
| Equalizer Type | 31 Band Graphic EQ, +/- 10dB |
| THD | <0.03% |
| Frequency Response | 20Hz - 20kHz |
| Crossover | 3-Way LPF, BPF, HPF THP per channel |
| Crossover Type | Linkwitz-Riley 24db slope |
| Sampling | 48kHz |
| S/N Ratio | 105dB @ 5-volts RMS |

| | |
|------------------------|---|
| Operating Voltage | 10-16 volts DC |
| Standby Current Draw | 7mA |
| Operation Current Draw | 150mA |
| Adjustments/Controls | Application via Bluetooth |
| Remote Output | 12 volts DC (signal sense or with ignition) |





AXDSPX-GL44

INSTALLATION INSTRUCTIONS

Having difficulties? We're here to help.



Contact our Tech Support line at:

386-257-1187



Or via email at:

techsupport@metra-autosound.com

Tech Support Hours (Eastern Standard Time)

Monday - Friday: 9:00 AM - 7:00 PM

Saturday: 10:00 AM - 7:00 PM

Sunday: 10:00 AM - 4:00 PM



KNOWLEDGE IS POWER

Enhance your installation and fabrication skills by enrolling in the most recognized and respected mobile electronics school in our industry. Log onto www.installerinstitute.com or call 800-354-6782 for more information and take steps toward a better tomorrow.



**Metra recommends MECP
certified technicians**