



INSTALLATION GUIDE

PART NUMBER: 152600

LIFT KIT

6TH GEN FORD BRONCO 4WD | 2021+

Depending on the Belltech lift kit you purchased, your ride heights will vary.

152600TP/152600HK: 4" to 7.5"

152600BK: 6"

300 W. PONTIAC WAY. CLOVIS, CA 93612

PHONE: 800-445-3767 | EMAIL: INFO@BELLTECH.COM

THANK YOU

Thank you for choosing our high quality Belltech product. We have spent a great deal of time developing our line of products so that you will receive maximum performance with minimal difficulty during installation. Soon your vehicle will be on the road looking and feeling much improved.

Please take a moment to read all instructions and warnings prior to installation of your new Belltech product and before operating your vehicle. If you have any questions or concerns regarding any step in the installation process, please do not hesitate to call or email our customer support specialists who are trained to help you through any portion of this process.

Before You Begin:

It is of the utmost importance that you confirm all of the components listed on the parts list is in the kit. You can find this list located on the last page(s) of your instructions. Do not begin installation if any part is missing. Instead, please call our Belltech customer service specialists.

Belltech Customer Support:

Phone: 1-800-445-3767

Email: info@belltech.com

Safety Information:

Warning: Do not work under a vehicle supported only by a jack. Place support stands securely under the vehicle in the manufacturer's specified locations unless otherwise instructed.

Proper use of safety equipment and eye/face/hand protection is absolutely necessary when performing any of the following instructions.

We strive for an exceptional experience for all our valued customers. If for any reason you need assistance with your Belltech products, please do not return the product to the store you purchased from, but rather call our dedicated customer service experts, from 6am to 5pm PST.

We recommend that a qualified mechanic, at a properly equipped facility, perform this installation.

It is very helpful to have an assistant available during installation.

Before Driving Your Vehicle:

It is important to double check all brake hoses, cables, and other components to be sure there is no interference. You must also check for wheel/tire to chassis/body interference. If any issues are found, review your installation instructions to be sure no steps were missed and any problems are corrected.

Make sure your vehicle is aligned immediately following installation.

Check all hardware and re-torque at intervals for the first 10, 100, and 1000 miles.

Some of Belltech's products are designed to improve your vehicle's off-road performance. Leveling/lifting your vehicle may result in an altered center of gravity. It is crucial to use extreme care when operating your vehicle to prevent rollover and/or loss of control.

Any changes in your vehicle's suspension may result in transformed handleability. Please test-drive your vehicle in a remote location so you can become accustomed to the revised driving characteristics.

Perform headlight check and adjustment.

Failure to drive any modified vehicle in a safe manner may result in harm or death.

Never operate your modified vehicle under the influence of drugs, alcohol, or lack of adequate sleep.

Always wear your seatbelt.



DIFFICULTY:

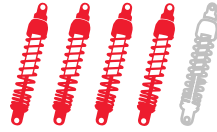

INSTALLATION TIME:

10-12 Hours
+ Alignment

RECOMMENDED TOOLS:

- Properly rated floor jack
- Ratcheting socket wrench and socket set
- Hammer
- Sawzall and/or angle grinder with cutoff discs
- Flat head screwdriver or pry tool
- Support stands
- Wheel chocks
- Metric wrench set
- Tape measure
- Paint Pen
- Safety glasses
- metal file and sandpaper
- black spray paint

SPECIALTY TOOLS:

- High quality spring compressor
- Torque wrench up to 200lbs



FITMENT GUIDE

All 4.5" lifts:

18x9 w/ 5-1/2" BS—35x12.50

20x9 x/ 5-1/2" - 6-1/4" BS—35x15.50

All 7" Lifts:

18x9 w/ 5-1/2" BS—35x12.50

20x9 w/ 5-1/2" BS—35x12.50

20x9 w/ 6-1/2" BS—37x12.50

INSTALLATION PREPARATION:

Before beginning the installation process, measure the hub to fender heights for your vehicle and record them in the "Before" section. After your vehicle has been modified, record the new measurements in the, "After" section. This way, you can compare the resulting height to the original. When taking the measurements, measure vertically from the center of the wheel to the inner edge of the fender.

Before:

LF: _____

RF: _____

LR: _____

RR: _____



After:

LF: _____

RF: _____

LR: _____

RR: _____

JACKING, SUPPORTING, AND PREPARING THE VEHICLE

1. Park your vehicle on a smooth, level, concrete or seasoned asphalt surface.
2. Block the rear wheels of the vehicle using wheel chocks. Make sure the vehicle's transmission is in "PARK" (automatic) or 1st gear (manual).
3. Activate the parking brake.
4. Loosen, but do not remove, the front wheel lug nuts.
5. Lift the front of the vehicle off the ground using a properly rated floor jack. Lift the vehicle so the front tires are approximately 6-8 inches off the ground.
6. Place support stands rated for the vehicles weight. The stands should be positioned in the factory specified locations. (Refer to owners manual). Prior to lowering the vehicle onto stands, make sure the support stands will contact the chassis. It is very important that the vehicle is properly supported to prevent any harm to ones self or to the vehicle.
7. Lower the vehicle slowly onto the stands.
8. Remove the front wheels.



Technician reminder:

Never work under a vehicle supported only by a jack. It is necessary to place support stands securely under the vehicle in the manufacturer's specified locations unless otherwise instructed.

FRONT REMOVAL

9. Remove the front skid plate.
10. Remove the front sway bar from the vehicle entirely by unbolting the endlinks, and brackets securing it to the vehicle. If your model includes electronic swaybars, it is important to remove the bar carefully to prevent damage to wires or connectors.
11. Remove the outer Tie rod from the spindle by loosening the nut, then striking the designated bosses with a deadblow hammer until the ball joint loosens. Once loose, remove the nut, and dismount the tie rod from the spindle.

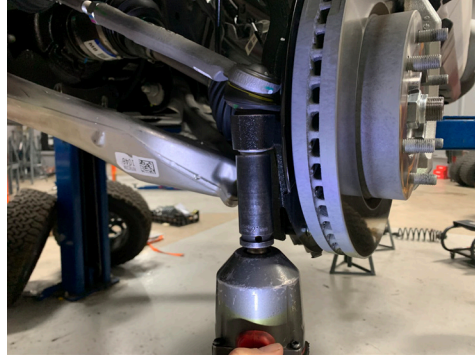

12. Remove the ABS sensor wire from the spindle to prevent damaging any cables.

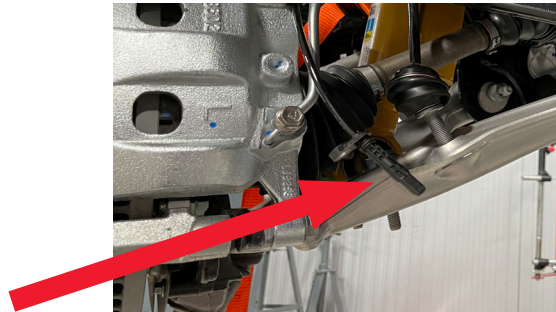

13. Unbolt and secure out of the way any additional brake line or ABS brackets from the spindle.

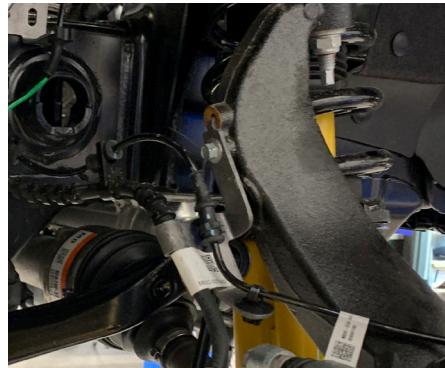

14. Unbolt the Brake caliper and hang it securely in the wheel well to prevent from overstretching or kinking the brake hoses.

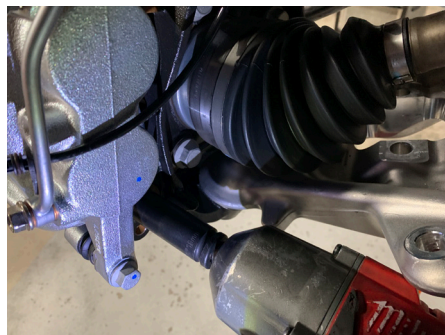

15. Remove the Brake Rotor from the Hub.

FRONT REMOVAL CONTINUED

16. Using a 35MM socket, remove the axle nut from the axle then strike the Axle carefully with a deadblow hammer to dislodge it from the hub. Be careful not to damage the threads on the axle.



17. Loosen but do not remove the nuts on the upper and lower ball joint.

18. Strike the spindle on the designated bosses to separate the upper control arm from the spindle. It is important to be careful, as the control arms may be under tension. Once free, support the spindle as you remove the upper and lower ball joint nuts. Allow the spindle to droop as you slide the axle shaft out of the hub. Additionally the axle should also be supported so it does not separate the joints in the CV or droop too far.

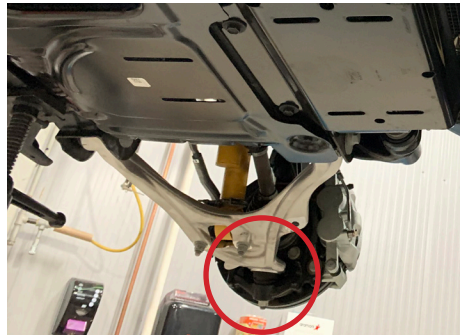

19. Disassemble the hub and backing plate from the OEM Ford spindle to be installed onto the Belltech Spindle using the OEM Hardware. Use an 18mm socket to remove the bolts fastening the hub to the spindle.



FRONT REMOVAL CONTINUED

20. Remove the Struts by unbolting the lower mounting hardware, and then removing the nuts on the top mount. Support the strut while doing this to avoid dropping it.



21. Remove the lower control arms by unbolting the mounting hardware.

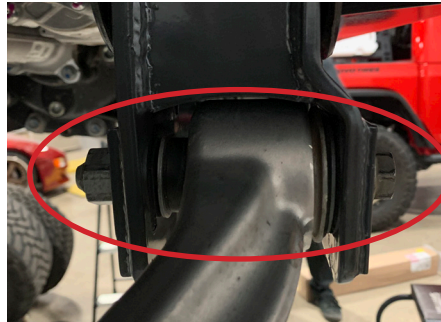

22. Disconnect the front driveshaft from the front differential by removing the 6 bolts. It is recommended to zip tie the driveshaft or support it to not droop down causing unnecessary stress on the joints.



23. Disconnect all hoses and connectors from the front differential. This will prevent from tearing or stretching any hoses, lines or cables. (This step will vary depending on the vehicles equipped options.)



FRONT REMOVAL CONTINUED

24. Make sure to securely support the front differential with a jack, then remove the 2 18mm bolts on the back of the differential above the input shaft and the passenger side differential support bolt.

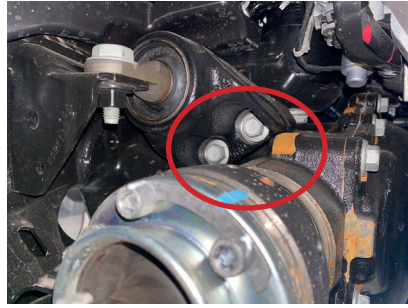

25. Remove the front differential mount bolt holding the differential to the bracket and then carefully lower the differential and place it aside safely. Be careful to check for any missed wires or hoses while lowering the differential.
26. Remove the differential bracket from the frame.
27. Using a paint pen mark vertical lines to cut along the rear crossmember on the front side. Measure from the drivers side flange horizontally (reference below). The inner cut line closer to the center of the vehicle can be wrapped around the crossmember. on the outer side marking, use the paint pen to wrap the cut line around the front of the crossmember only up to the seam weld.

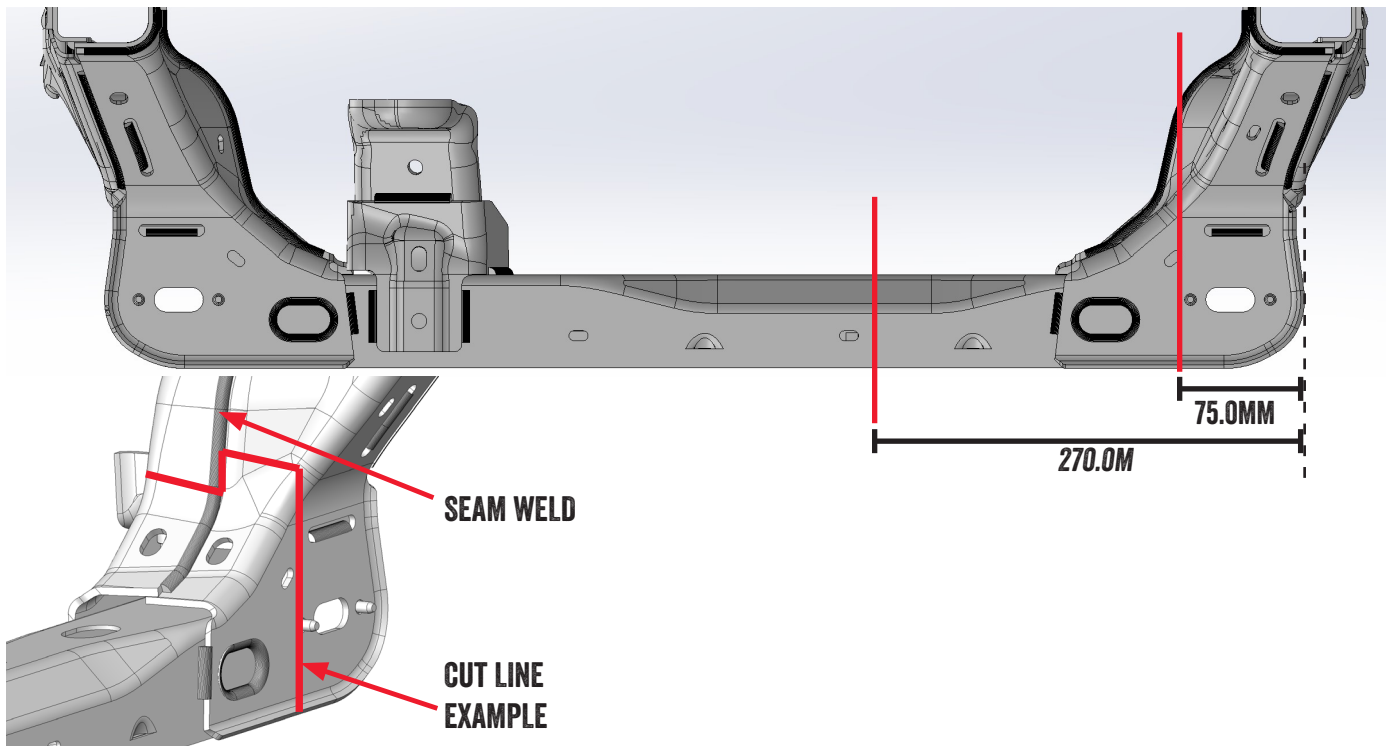

28. On the back side of the rear crossmember, measure 7MM inwards from the alignment pin and draw a vertical line, then wrap the paint pen line around to the seam weld. the two lines should not meet but be offset. Connect the two lines with the paint pen along the seam weld.
29. Using a reciprocating saw with a long metal cutting blade, cut along the marked lines. It may be helpful to use a cut off disc on an angle grinder to score the marked lines before using the reciprocating saw. After making the cuts, and removing the cut section, it is important to smooth out the cut with a file or sandpaper and spray paint the exposed metal to prevent any corrosion.

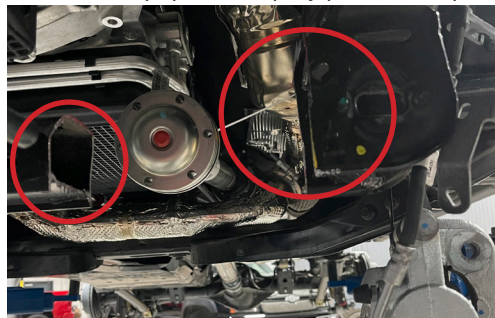

FRONT REMOVAL CONTINUED

30. To create clearance on the differential, use a grinder to remove the small lobe by the rear upper mounting holes as shown. in the images below.

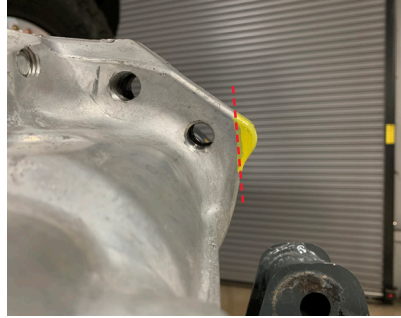

31. Only if the front differential has the large coupler on the passenger side as shown, you will have to cut or grind the small aluminum protusion on the back side of your power steering rack as shown.

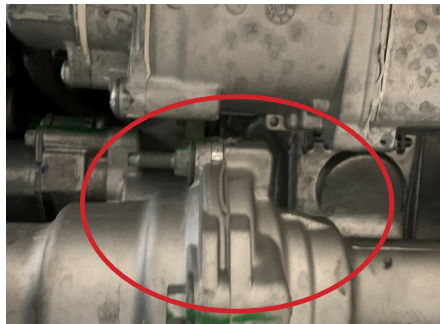

FRONT INSTALLATION

1. Install the Belltech front skid plate using the OE front skid plate hardware. It will mount between the Belltech crossmember and frame
2. Install the Belltech front and rear crossmembers using the supplied hardware.



Technician note:

Re-installation of your front end will be performed in the reverse order of removal. If it helps you to have photographs to reference, you may view the images from the Front Removal section.

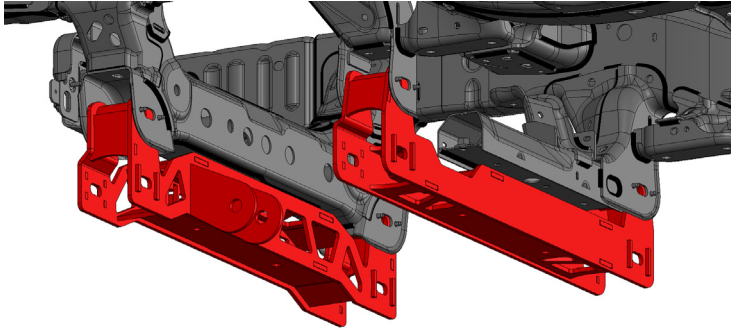

3. Raise the differential into place between the crossmembers. Install it but do not fully tighten the front and passenger side differential bolts
4. Install the rear differential mount plate with the cut out notch facing inward and upward. Use the OE bolts on the bottom and the supplied bolts on top.
5. Ensure at least 5MM of clearance between the side of the differential and the cut section of the frame. Also check for atleast 5MM of clearance between the power steering rack and large differential coupler on the passenger side. (if applicable)



6. Tighten all differential bolts to OE specs and connect all electrical connections and hoses.



7. re-install the front driveline to the differential using the belltech driveline spacer and provided extended hardware.

FRONT INSTALLATION CONTINUED

8. Install the Spacer, Strut, or Coilover combination that came with your kit. Depending on which kit was purchased, reference the individual instructions now.
9. Reinstall the lower control arms using the OE Hardware. Do not torque these until the vehicle is on the ground to prevent the bushings from being overstressed or holding height.



10. Install the assembled Belltech spindle onto the upper and lower ball joints using the OE hardware. Be sure to re install the Hub and brake backing plate removed in step 19 of the removal onto the Belltech spindle.
11. Install the Belltech brake line drop brackets to the frame and attach the OE brake lines and wires. Ensure they will not catch on any moving parts or stretch while turning.



12. Install the ABS sensor into the spindle.
13. mount the brake rotor to the hub and install the brake caliper. Ensure that the brake backing plate is re installed. Check again for any wires or brake lines that could catch on other components or interfere when turning.
14. Install the outer tie rod into the tie rod arm of the spindle and torque to OE spec.
15. Install the sway bar drop down brackets onto the frame re using the factory hardware.
16. Install the swaybar onto the drop brackets using the provided hardware. Connect the end links to the control arms with the factory hardware.
17. Install the Belltech lower skid plate using the supplied hardware. If your vehicle is equipped with a swaybar skid plate, the belltech skid plate will be mounted between the OE skid plate and the rear crossmember.
18. Check all fastening hardware and ensure no steps have been missed.
19. Install the wheels and lower the front end to the ground.

REAR REMOVAL/INSTALL

1. Before beginning the rear installation, set all of the Belltech adjustable rear suspension links to the recommended base lengths. **(see bottom of page)** Tighten the jam nuts while off the vehicle. Be aware that the Belltech recommended lengths are not absolute. They are a suggestion and can be further tuned to change the driving and alignment characteristics of the vehicle. do not rely on the suggested lengths, a professional alignment must still be performed to ensure safe operation of your vehicle.
2. Lift the rear end and support it with jacks using the manufacturers recommended procedure. Remove any fender liners.
3. Remove the struts (refer to your product specific instructions that were included with your kit)
4. Completely remove the rear track bar, and keep the OE hardware. The OE hardware will be used on the install.
5. Unbolt the driver side rear exhaust hanger bracket from the frame.
6. Install the rear roll center correction bracket around the frame and OE track bar mount.

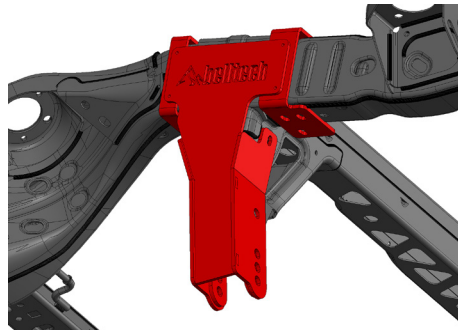

7. Insert the supplied M16 bolt, from front to back, through new bracket and OE frame side trackbar hole. Ensure the steel crush sleeve is on the bolt and only use a washer on the nut side. The nut should be on the back side of the bracket facing the rear of the vehicle. Do not torque yet. Failure to install the bolt in the correct orientation will cause the axle to come into contact with the bolt and can damage your brake line.
8. Insert the two supplied M12 bolts, with nuts and washers, through the front and back holes near the base of the bracket.



9. Using the remaining hardware, install the inner frame support plates.
10. Re attach exhaust hanger bracket with OE hardware.
11. Torque m16 bolt to 220 ft-lbs, then torque all m12 bolts to 100 ft-lbs.
12. Install Belltech track bar, set to length suggested above, with the adjustable rod end on the axle side, and the bushing side in the proper hole for the desire lift. Place bolt head in hex cut out on the front side of the bracket. See below for all suspension link

Desired Lift (in)	Track bar mount hole
3-4	upper
4-5	middle
5-6.5	lower

Suspension link	Suggested length
Rear Track Bar	Match to OEM Bar
Rear Upper Control Arm	380mm
Rear Lower Control Arm	673mm

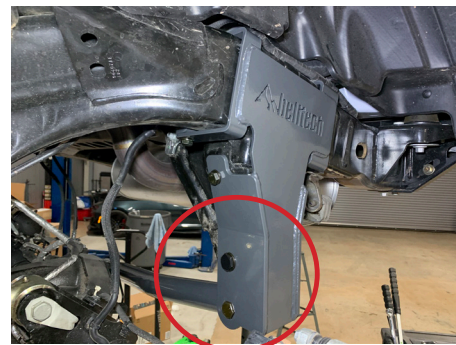

REAR REMOVAL/INSTALL

13. Un bolt brake line bracket from passenger side top of axle.
14. Install belltech extension bracket to axle using oe bolt and attach oe bracket to extension with supplied m8 hardware.

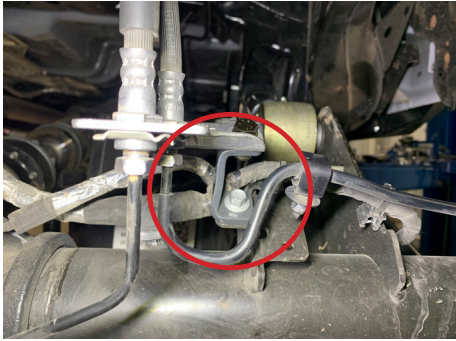

Technician note (Rear Installation):

WARNING: Use caution when working around an open fuel source. No smoking, grinding, etc. it is highly recommended to temporarily cover or plug the opening on the tank.

15. Loosen hose clamp and disconnect the large fuel filler hose from fuel tank.
16. Support fuel tank as evenly as possible with a jack or transmission jack.
17. Remove all bolts securing the fuel tank to frame. Some models will have bolt-on straps holding the tank, and some models will have a large skid plate holding the tank.
18. Carefully lower the tank 3-5 inches. Be sure not to pull on any hoses or wires. If necessary, un plug the wire harness. There is a vent hose that runs the length of the top of the tank. This hose does not need to be disconnected, but will need to be un clipped from the top of the tank to allow the tank to drop more.
19. Lower the tank more, about 6-8 inches in total, to allow access to both passenger control arm bolts.



20. Remove the protective covers on passenger control arm bolts.



21. Loosen but do not remove all 8 control arm bolts. All OE hardware will be re used with new arms.
22. Ensure the axle is fully supported and will not rotate when control arms are removed. Working in pairs (both upper arms, then both lower arms) replace all factory control arms with belltech adjustable control arms. The adjustable rod ends will be installed on the axle side of all arms. Do not tighten bolts yet.

REAR REMOVAL/INSTALL

23. Using a floor jack, raise your axle until your hub to fender measurement matches your desired ride height. (your “before” measurement written on page 2, plus your desired lift amount) Alternatively, set your rear upper control arms at a 9 degree angle, and/or your lower control arms to a 15 degree angle. Now tighten and torque all 8 rear control arm bolts. Failure to tighten rubber bushings at ride height will cause stress and premature failure.
24. Re install all control arm bolt covers.



25. Raise fuel tank back into position. Be sure to re connect any electrical connectors and clip vent lines back into place if removed.
26. Tighten all fuel tank mounting bolts and re connect fuel filler hose.
27. With floor jack still under axle, raise the axle through its full travel. Ensure there is no contact between axle and roll center relocation bracket. If any contact occurs, adjust rear control arms as needed.
28. Install the belltech struts or coilovers to frame and axle (Reference the specific instructions included with your coilovers or struts).
29. Check the clearance between passenger upper control arm bolt cover and fuel tank skit plate. If any contact occurs, bend or trim the back edge of the skid plate as needed. If cutting, ensure all fuel hoses are secure to prevent sparks from igniting fuel vapors.
30. Re install the fender liner



Technician note (Rear Installation):

Depending on the kit you purchased, your rear suspension will include struts or coilovers. The rear suspension will come with its own set of instructions, which you can reference for installation.

If the kit you purchased includes a Belltech anti-sway bar kit, please reference the rear sway bar instructions to install your rear sway bar after installing your rear Belltech suspension.

FINALIZING THE INSTALLATION

31. Re-install the wheels and tighten the lug nuts.
32. Lift the vehicle and remove the support stands.
33. Carefully lower the vehicle onto the flat ground.
34. Torque the lug nuts to manufacturer's specifications.
35. Check that all components and fasteners have been properly installed and torqued.
36. Re-read and perform all tasks in the "Before Driving Your Vehicle" section of page 1 of your instructions.



belltechsuspension



Belltech Suspension



@belltechsuspension

THANK YOU FOR CHOOSING BELLTECH.

You are now a part of the Belltech family and we are eager to catch a glimpse of your newly modified vehicle. Give us a shout out and let us know how much you love our product. Don't forget, we offer other Belltech related merchandise for you and your vehicle on our website, www.belltech.com!

If you have any questions, concerns, or warranty related issues regarding your Belltech product, please call or email our experienced customer service specialists.

Belltech Customer Support:

Phone: 1-800-445-3767

Email: info@belltech.com

KIT CONTENTS

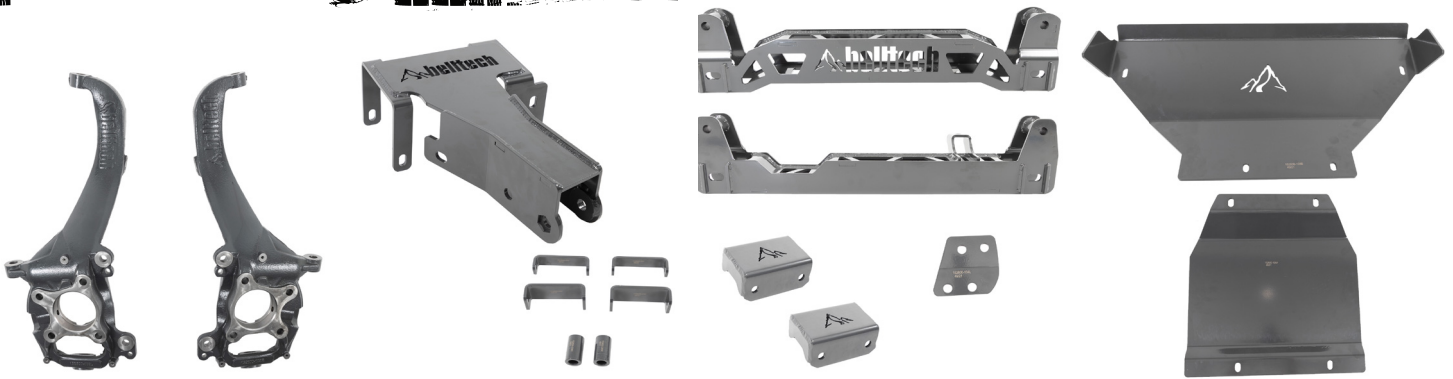

LK2021		
Part number	Description	Qty
152600-103R-982	LIFT SPINDLE RH	1
152600-103L-982	LIFT SPINDLE LH	1

LK20006 (REAR COMPONENT KIT A)		
Part number	Description	Qty
152600-211	REAR ADJ UPPER CONTROL ARM	2
152600-212	REAR ADJ LOWER CONTROL ARM	2
152600-215	REAR ADJ TRACK BAR	1

LK20004		
Part number	Description	Qty
152600-101-992	FRONT CROSSMEMBER	1
152600-102-992	REAR CROSSMEMBER	1
152600-104L-992	DIFFERENTIAL DROP LH	1
152600-113-992	SWAYBAR DROP DOWN	2
LK20008	SUB KIT A	1

LK20007 (REAR COMPONENT KIT B)		
Part number	Description	Qty
152600-200-992	REAR ROLL CENTER CORR	1
152600-226-992	REAR BRAKE LINE BRKT	1
152600E-777	HARDWARE KIT	1
152600I-777	HARDWARE KIT	1

LK20008 (SUB KIT A)		
Part number	Description	Qty
152600-128-992	FRONT BRAKE LINE BRKT	2
152600-140-966	DRIVELINE SPACER	2
152600A-777	HARDWARE KIT	1
152600B-777	HARDWARE KIT	1
152600C-777	HARDWARE KIT	1
152600F-777	HARDWARE KIT	1
152600G-777	HARDWARE KIT	1
152600H-777	HARDWARE KIT	1
152600J-777	HARDWARE KIT	1

LK20005		
Part number	Description	Qty
152600-108A-992	MAIN SKID PLATE	1
152600-108B-992	FRONT SKID PLATE	1
152600D-777	HARDWARE KIT	1

KIT CONTENTS

152600A-777 Hardware Kit

Part number	Description	Qty
110219	M16 WASHER	6
110242	M16x2.0 LOCK NUT	3
112135	M16X2.0 BOLT	3

152600B-777 Hardware Kit

Part number	Description	Qty
110219	M16 WASHER	4
110242	M16x2.0 LOCK NUT	2
112135	M16X2.0 BOLT	2

152600C-777 Hardware Kit

Part number	Description	Qty
110225	BOLT M12 x 1.75 - 30MM	4
110228	WASHER FLAT M12	8
112165	NUT NYLOCK M12 X 1.75	4

152600D-777 Hardware Kit

Part number	Description	Qty
112142	FLANGE BOLT M10 X 1.5	4

152600E-777 Hardware Kit

Part number	Description	Qty
110239	WASHER FLAT M10	10
110244	NUT (NYLOCK) M10-1.25	5
112135	BOLT M16 X 2.0 - 115MM	2
110219	WASHER FLAT M16	2
110242	NUT NYLOCK M16 X 2.0	2
110298	BOLT M10x1.25 - 30MM	5
110225	BOLT M12 x 1.75 - 30MM	1
112165	NUT NYLOCK M12 X 1.75	1
110228	WASHER FLAT M12	2

152600F-777 Hardware Kit

Part number	Description	Qty
110291	BOLT M12X1.75-75MM	2
110228	WASHER FLAT M12	4
112165	NUT NYLOCK M12 X 1.75	2
110222	NUT NYLOCK M14 X 2.0	2
110223	WASHER FLAT M14	4
110296	BOLT M14x2.0 - 60MM CL10.9	2

152600G-777 Hardware Kit

Part number	Description	Qty
110239	WASHER FLAT M10	2
110238	NUT NYLOCK M10 X 1.50	1
110297	BOLT M10x1.5 - 75MM	1

152600H-777 Hardware Kit

Part number	Description	Qty
110232	BOLT M8 x 1.00 - 16MM	2
110245	WASHER FLAT M8	4
110233	NUT NYLOCK M8 X 1.00	2
112011	FLANGE BOLT M8 X 1.25	2
112147	FLANGE NUT M8X1.25	2

152600I-777 Hardware Kit

Part number	Description	Qty
112011	FLANGE BOLT M8 X 1.25	1
112147	FLANGE NUT M8X1.25	1

152600J-777 Hardware Kit

Part number	Description	Qty
112199	BOLT M8X1.25-70MM	6