

Serial Number

Please read **BOTH** these Installation Instructions and the General Towing Instructions before attempting to install or operate this equipment.

- Blue Ox® towing products and accessories are intended to be installed by Blue Ox® Dealers who are familiar with our products and have the equipment and knowledge to do “fit work”. When necessary, Blue Ox® Dealers can be found at www.blueox.com or by contacting our Customer Care Department at (888) 425-5382.
- Many Blue Ox® Baseplates are designed to use existing holes and hardware to mount the baseplate to the towed vehicle. Even though bolts are there, do not assume they are adequate for baseplate mounting. Always use hardware supplied in the hardware kit or existing hardware specified in the Baseplate Installation Instructions.

Attachment Tab Height: 18”
Attachment Tab Width: 18”

Bolt Torque Specifications
Torque in Foot-Pounds for Metric Bolts

Bolt Size	Grade 8.8	Grade 10.9
6MM	6	8
8MM	16	22
10MM	31	40
12MM	54	70
14MM	89	117

Confirm the towability and pre-towing procedures for your vehicle with the owner’s manual or contact the vehicle’s manufacturer for specific towing procedures.

Bolt Torque Specifications
Torque in Foot-Pounds for Inch Bolts

Bolt Size	Grade 5	Grade 8
1/4”	10	14
5/16”	19	29
3/8”	33	47
7/16”	54	78
1/2”	78	119
5/8”	154	230



⚠ WARNING

Failure to read and follow these instructions could result in separation of the towed vehicle from the tow bar, causing property damage, loss of towed vehicle, personal injury or death.

BX1127
2008-10 Jeep Patriot
 Installation Instructions

Parts List

Ref. No.	Qty.	Part #	Description
1	1	61-6533	WELDMENT, BASEPLATE, BX1127
2	8	61-5208	WLDT, NUT PLATE, 1/4X1X1, 3/8 BLT WIRE
3	1	102-6889	SPACER, 1/2 X 1 X 1 1/2" (W .531 HOLE)
4	5	201-0440	3/8-16 X 1 1/2 HEX BOLT, GRADE 5, ZP
5	3	201-0444	3/8-16 X 2 HEX BOLT GRADE 5, ZP
6	8	203-0010	3/8 LOCK WASHER, ZP
7	2	201-0553	1/4-20 X 1/2 HX.WSHD.TYPE F TCS, ZP
8	2	201-0192	10-32 X 1/2 SLOT, RD. HD. SCREW
9	2	203-0054	#10 LOCK WASHER
10	2	202-0047	#10-32 HEX NUT
11	2	101-5822	ADAPTER, 4 WAY CONNECTOR
12	2	62-3469	ATT TAB ASSY, REM, SF/LB, 1 HOLE
	2	226-0046	BASEPLATE SAFETY CABLE, 36" CL III (NS)
	2	229-0359	QUICKLINK, 3/8, ZP (Not Shown)
	2	290-0437	RECEIVER, CAP PLUG (BLACK) (Not Shown)

Tools Required

- Loctite® RED
- 7MM Socket
- 10MM Socket
- 9/16" Socket
- T20 Torx
- Large Vise Grips
- Reciprocating Saw
- 13/32" Drill Bit
- Flat Screwdriver

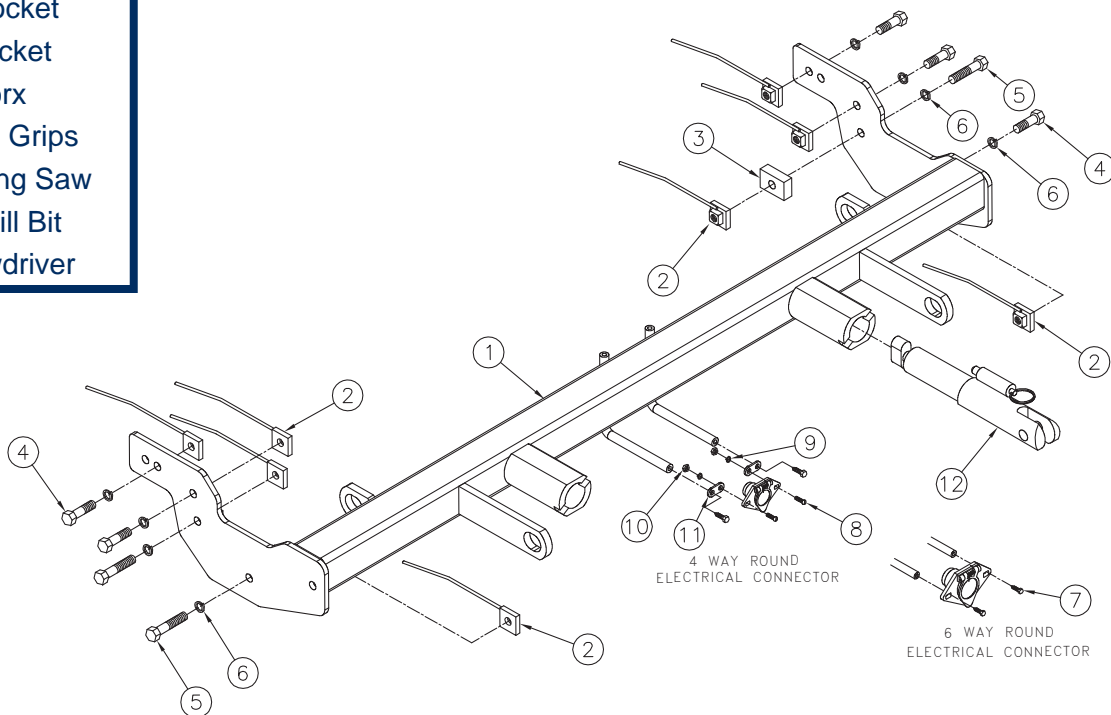

Important:

Use only genuine factory replacement parts on your baseplate. Do **NOT** substitute homemade or non-typical parts. If a bolt is lost or in need of replacement, for your safety and the preservation of your baseplate, be sure to use a replacement bolt of the same grade (In most cases it will be Grade 5, please reference the parts list above). Replacement parts may be ordered through your nearest Blue Ox® Dealer or Distributor.

BX1127

2008-10 Jeep Patriot

Installation Instructions

Attachment Tabs:

Motorhome mount tow bars are recommended for use with this baseplate. Due to the design of the removable tabs, the RangeFinderII, Adventurer, and Ambassador tow bars can not be used. The Acclaim tow bar may be used, but will not fold and store on the front of the vehicle. Adapters, except the BX8833 and BX88151, can not be used with this baseplate.

Installation Notes: The fascia and horn are removed for the baseplate installation. Trimming of the frame is required. Drilling is required.

The dimensional variations between otherwise identical vehicles can be considerable. While the baseplate was designed for easy installation, it may be necessary to tailor the baseplate slightly to compensate for auto manufacturer's tolerances. These minor adjustments may include filing a hole slightly, bending electrical rods, and/ or bending end plates.

The BX8869 Bulb and Socket Wiring Kit is recommended for this vehicle.



Installation Instructions:



1. Remove seven bolts with a T20 Torx from across the top of the fascia (driver's side shown in photo). Set bolts aside to be reinstalled later.



2. Just forward of the front tire, inside the wheel well, remove three bolts with a 7MM socket. Do this to both sides of the vehicle. Set bolts aside to be reinstalled later.

BX1127
2008-10 Jeep Patriot
Installation Instructions



3. Under the fascia remove the two pushpins in front of the tire. Do this to both sides of vehicle. Set pushpins aside to be reinstalled later.



4. In the middle under the fascia, remove the two clips by pushing the sides of the clip together with a small screw driver. Set the clips aside to be reinstalled later.



5. In front of the tire pull the wheel well cover back to remove the bolt with a 7MM socket. Do this on both sides. Set the bolt aside to be reinstalled later. Pull forward on the fascia to remove it, disconnect the turn signals and running lights (if applicable). Do this on both sides. Set the fascia aside carefully to be reinstalled later.

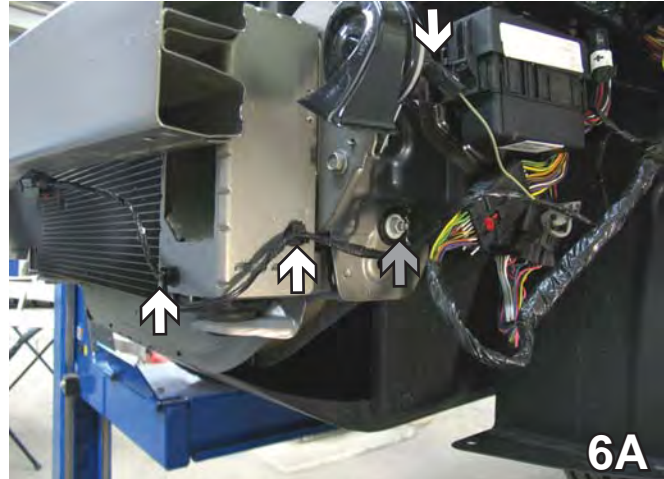

6. On the driver's side, remove the two Christmas tree pins and unplug the horn. Using a 13MM socket, remove the two bolts (gray arrows). Set bolts aside to be reinstalled later.



BX1127
2008-10 Jeep Patriot
Installation Instructions

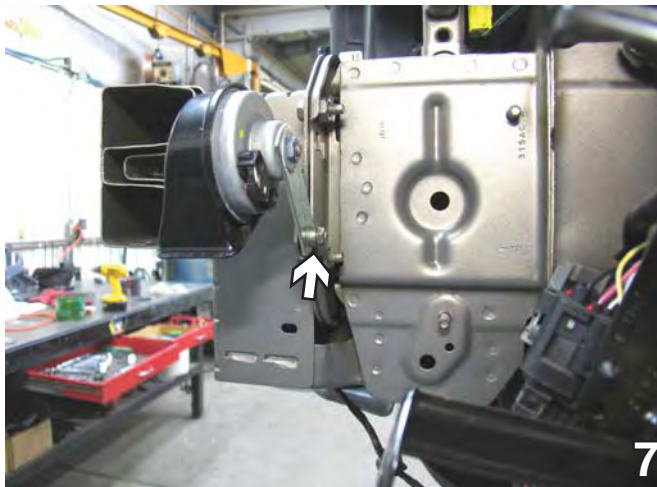

7. Use a 10MM socket on the back to remove the bolt and horn. Set aside to be reinstalled later.

Using a good quality paint, spray cut edges of frame to prevent rusting.



9. On the passenger side, align the baseplate with the existing hole, be sure the baseplate is level and clamp in place with the large vice grips. Using the baseplate as a template, drill the additional three holes with the 13/32" drill bit. In order to protect the hoses, put a tube over the drill.

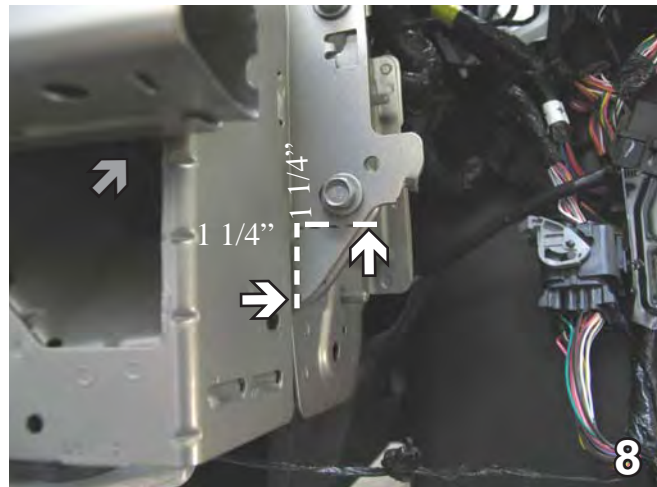

8. Using a reciprocating saw, notch out the corner by measuring up from the bottom 1 1/4" and 1 1/4" across. Do this on both sides. We recommend painting the cut edges to prevent them from rusting.

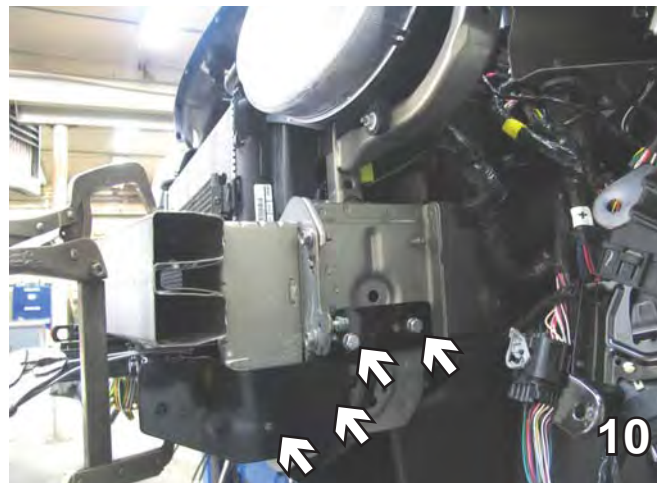

10. On the driver's side, insure the baseplate is level with the frame and clamp in place with the large vice grips. Using the baseplate as a template, drill four holes into the frame with the 13/32" drill bit.

BX1127
2008-10 Jeep Patriot
Installation Instructions

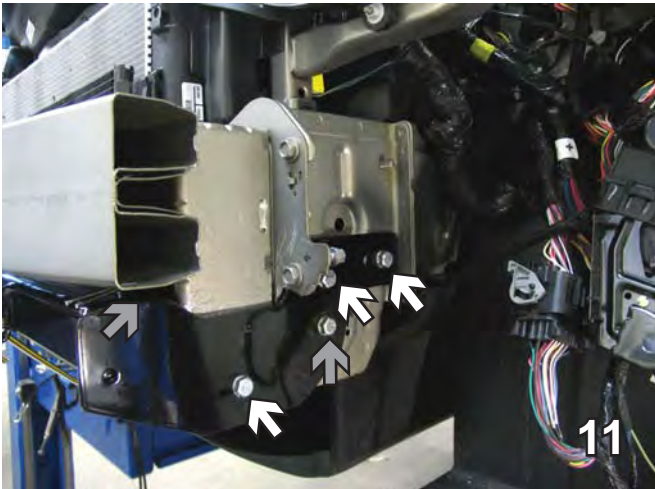

11. On the driver's side, install 3/8 x 1 1/2" bolts with 3/8" lock washers and tighten to 3/8-16 nut plates (white arrows). The top two nut plates are inserted from the front (see gray arrow on photo in step 8 for opening) and the bottom two are inserted from the bottom. Install the 1 x 1 1/2" spacer plate between the baseplate and the frame (gray arrow) and install 3/8 x 2" bolt with 3/8" lock washer and 3/8-16 nut plate. Use Loctite Red on all bolts.

BE SURE TO USE LOCTITE® RED ON ALL BOLTS BEFORE TIGHTENING. TIGHTEN ALL BOLTS ACCORDING TO THE TORQUE CHART ON THE FRONT PAGE OF THESE INSTRUCTIONS OR ON PAGE 3 OF THE BASEPLATE TOWING GENERAL INSTRUCTIONS.



12. On the passenger side, install 3/8 x 1 1/2" bolts with 3/8" lock washers and tighten to 3/8-16 nut plates for the top two holes (white arrows). In the bottom two, install 3/8-16 x 2" bolts with 3/8" lock washers and tighten to 3/8-16 nut plates (gray arrows.)



14. Attach the permanent baseplate safety cables to the provided convenience link on the baseplate. The photo above shows the recommended installation of the cables to frame of vehicle. Additional options may interfere with suggested mounting; in this case secure the cables to a solid piece of the frame as described in the instructions included with the permanent baseplate safety cables. Be sure the safety cables do not rub against any hoses or moving parts. Do this to both sides of the vehicle.

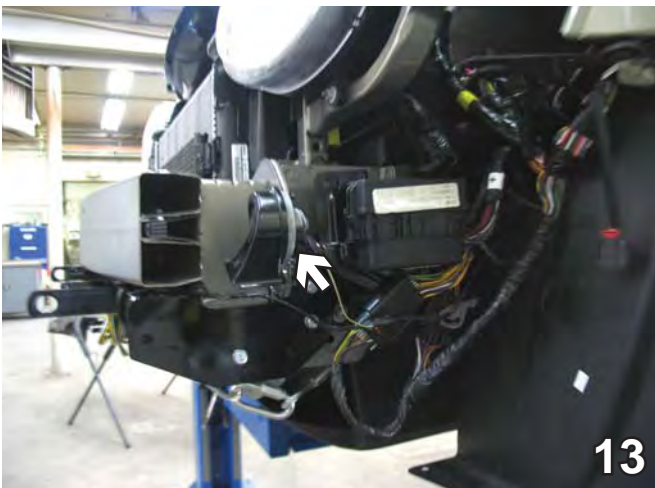

13. Reinstall the horn and reconnect.

BX1127

2008-10 Jeep Patriot

Installation Instructions

15. Reinstall the fascia and reconnect all the lights. Be sure to reinstall all the bolts, clips and pins.

Install the tow bar and safety cables according to their instructions. When demonstrating this to the customer, be sure to include all of the Blue Ox packaging and contents.

DO NOT substitute other devices if the tow bar pins and clips are misplaced.

Be sure that **ALL** electrical connections are plugged in properly and functioning **BEFORE** installing the fascia.

DEALER or INSTALLER:

Be certain the user receives the instruction sheets for their products.

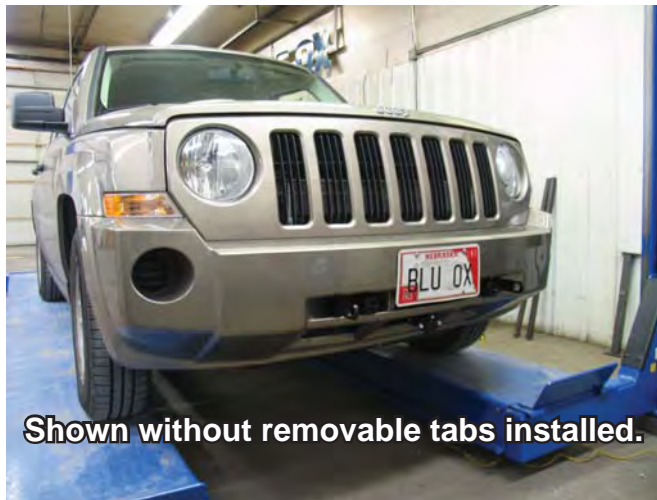

Shown without removable tabs installed.

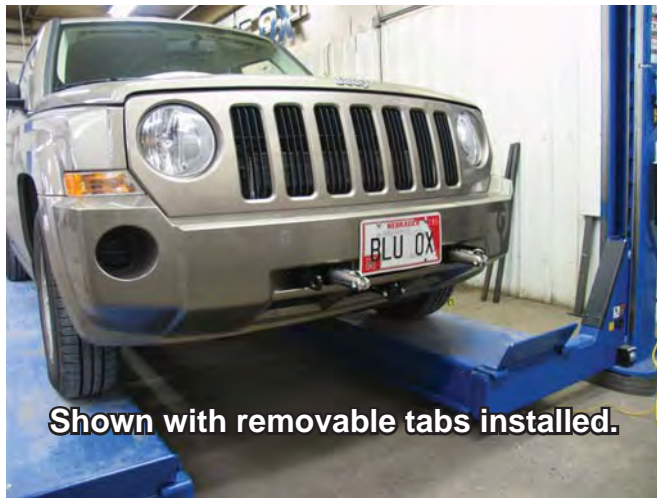

Shown with removable tabs installed.

CUSTOMER SERVICE COMMITMENT

Blue Ox is committed to providing you with exceptional customer care throughout your lifetime with our products. Our team is here to assist you with any questions you may have regarding the performance of your product. Simply call 1-800-228-9289 and you can speak with our customer care team.

Additionally, please visit our website to see which rallies our Destination America team will be attending. For a nominal fee, our service technician will service your towing system to ensure it's in proper working condition. Also as a commitment to our customers, should you visit our factory you can stay at our full service Blue Ox campground at no charge along with enjoying a factory tour.

Again thank you for being our customer and for the confidence you have shown in the performance of our products. It is because of customers like you we enjoy the success we have today.

If the baseplate is in an accident, it must be replaced. **DO NOT** use it again! An accident can cause unseen damage and using it again could result in more damage or serious injury. **DO NOT** use the baseplate if it is damaged or missing parts.



© 2008, 09 Blue Ox
One Mill Road, Industrial Park
Pender, Nebraska 68047
Phone: (402) 385-3051 • Fax: (402) 385-3360
www.blueox.com