



MINI 2-STAGE PROGRESSIVE NITROUS CONTROLLER

25973NOS, 25974NOS, and Upgrade Kits

INSTALLATION AND OPERATION INSTRUCTIONS

THANK YOU for purchasing the NOS Mini 2-Stage Progressive Controller! Your system is composed of the highest quality components available. It should provide many miles of trouble-free performance when used correctly. If you have any questions regarding the performance of your system, call NOS Technical Service at 1-866-464-6553.

NOTICE: Installation of Nitrous Oxide Systems Inc. products signifies that you have read this document and have agreed to the terms stated within.

It is the purchaser's responsibility to follow all installation instruction guidelines and safety procedures supplied with the product as it is received by the purchaser to determine the compatibility of the product with the vehicle or the device the purchaser intends to install the product on.

Nitrous Oxide Systems Inc. assumes no responsibility for damages occurring from accident, misuse, abuse, improper installation, improper operation, lack of reasonable care, or all previously stated reasons resulting from incompatibility with other manufacturers' products.

Nitrous Oxide Systems Inc. assumes no responsibility or liability for damages incurred by the use of products manufactured or sold by Nitrous Oxide Systems Inc. on vehicles used for competition or racing.

Nitrous Oxide Systems Inc. neither recommends nor condones the use of products manufactured or sold by Nitrous Oxide Systems Inc. on vehicles, which may be driven on public roads or highways, and assumes no responsibility for damages incurred by such use.

NOS nitrous oxide is legal for use in most states when used in accordance with state and local traffic laws. NOS does not recommend or condone the use of its products in illegal racing activities.

NOS has not pursued California Air Research Board (CARB) exemptions for these kits, hence, they are not legal for use on pollution- controlled vehicles in California. A correctly installed NOS nitrous system should not alter the emission control performance of your vehicle under standard EPA test cycle conditions.

HAZARDS DEFINED

This manual presents step-by-step instructions that describe the process of installing your NOS Mini 2-Stage Progressive Controller. These procedures provide a framework for installation and operation of this kit. Within the instructions, you are advised of potential hazards, pitfalls, and problems to avoid. The following examples explain the various hazard levels:

WARNING! Failure to comply with instructions may result in injury or death. CAUTION! Failure to comply with instructions may result in damage to equipment.

NOTE: This information is important, needs to be emphasized, and is set apart from the rest of the text.

HINT: These special instructions provide a handy work tip.

NITROUS OXIDE INJECTION SYSTEM SAFETY TIPS

WARNINGS!

IT IS NOT LEGAL TO ENGAGE NITROUS OXIDE INJECTION SYSTEMS ON PUBLIC ROADS OR HIGHWAYS. NITROUS OXIDE INJECTION SYSTEMS ARE ONLY TO BE ENGAGED DURING SANCTIONED COMPETITION OR RACING EVENTS.

Do not attempt to start the engine if the nitrous has been injected while the engine was not running. Disable the ignition system (consult owner's manual) and crank the engine with the throttle wide open for several revolutions before attempting to start. Failure to do so can result in extreme engine damage.

Never permit oil, grease, or any other readily combustible substances to come in contact with bottles, valves, solenoids, hoses, and fittings. Oil and certain gases (such as oxygen and nitrous oxide) may combine to produce a highly flammable condition.

Never interchange nitrous and fuel solenoids. Failure to follow these simple instructions can result in extreme engine damage and/or personal injury.

Never drop or violently strike the bottle. Doing so may result in an explosive bottle failure. Never change pressure settings of safety relief valve on the nitrous bottle valve. Increasing the safety relief valve pressure settings may create an explosive bottle hazard.

Please note that the NOS bottle label has changed to a two-part assembly. The first label is already located on the bottle. Upon filling your bottle with nitrous oxide, apply the (second) material information label in the area indicated in the picture to the right.

NOTE: The material information decal is located in the same plastic bag as the bottle.

WARNING! Once the nitrous bottle has been filled, it must be shipped according to the applicable transportation and shipping regulations!

Do not deface or remove any markings, which are used for content identification. Nitrous bottle valves should always be closed when the system is not being used.

Notify the supplier of any condition that may have permitted any foreign matter to enter the valve or bottle. Keep the valves closed on all empty bottles to prevent accidental contamination.

When storing a nitrous bottle, make sure the outlet is capped with a plug so that contaminants don't get into the fittings.

It is important that all threads on the valves and solenoids are properly mated. Never force connections that do not fit properly.

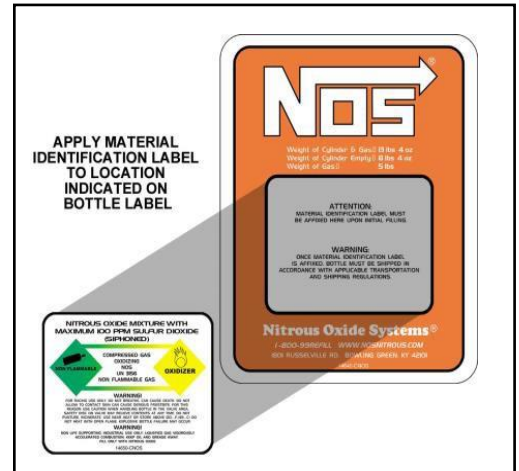

Table of Contents

Chapter 1 Product Overview.....	4
Chapter 2 Controller Installation & Wiring	4
Chapter 3 Hand-Held Setup	7
3.1 Home Screen	7
3.2 Main Menu	8
3.3 Nitrous Configuration	8
3.3.1 System Setup – RPM Signal.....	8
3.4 Stage 1 & Stage 2.....	9
3.4.1 Setup	9
3.4.2 Ramp Builder	10
3.4.3 TPS Autoset.....	10
3.4.4 Graph.....	11
3.4.5 Configuration	11
3.5 Save/Load Tune.....	12
3.6 Controller Setting	13
3.6.1 Touch Calibrate.....	13
3.6.2 Controller Info/Firmware Upgrade	13
3.6.3 Dash Setup	14
Chapter 4 – Hand-Held & Controller Firmware Update	14
Chapter 5 – System Operation & Testing	15
5.1 Initial Testing & Verification	15

Chapter 1 Product Overview

The NOS Mini 2-Stage Progressive Nitrous Controller is a fully featured progressive nitrous controller offering control of up to 2 individual stages and can be fully programmed via a hand-held LCD touch screen display. A micro SD (Secure Digital) memory card reader is located on the hand-held controller to store tunes and is used for any future updates.

The NOS Mini 2-Stage Progressive Nitrous Controller can control progressive solenoid operation based on time, RPM, and/or TPS input and can shut nitrous off at a programmed RPM ceiling. The programmable ramps can be configured in any curve shape or with the built-in ramp builder app.

The NOS Mini 2-Stage Progressive Nitrous Controller is designed and constructed in a manner to endure the typical harsh conditions found in a racing environment. The controller can be mounted in the engine or passenger compartment. It is advisable to keep the controller away from direct heat and severe vibration. Although not required, it is beneficial to use rubber isolators when mounting the controller on applications that may see severe tire shake, etc.

A progressive, 2 stage nitrous system works by pulsing each set of solenoids for a user defined start time, cycle time, and duration. This NOS Mini 2-Stage Progressive Nitrous Controller allows the user to drive the solenoids at different times, to tailor power delivery to the engine as needed. The user can choose to utilize a window switch (RPM), a throttle position sensor (TPS), and/or a microswitch to trigger the controller.

When the user sets up the controller or chooses the trigger mechanism, they can utilize the time delay option to trigger the first or second stage of nitrous when it is most needed. This could be after the vehicle has launched (low traction, first stage), and then has traction later on in the run (second stage).

Chapter 2 Controller Installation & Wiring

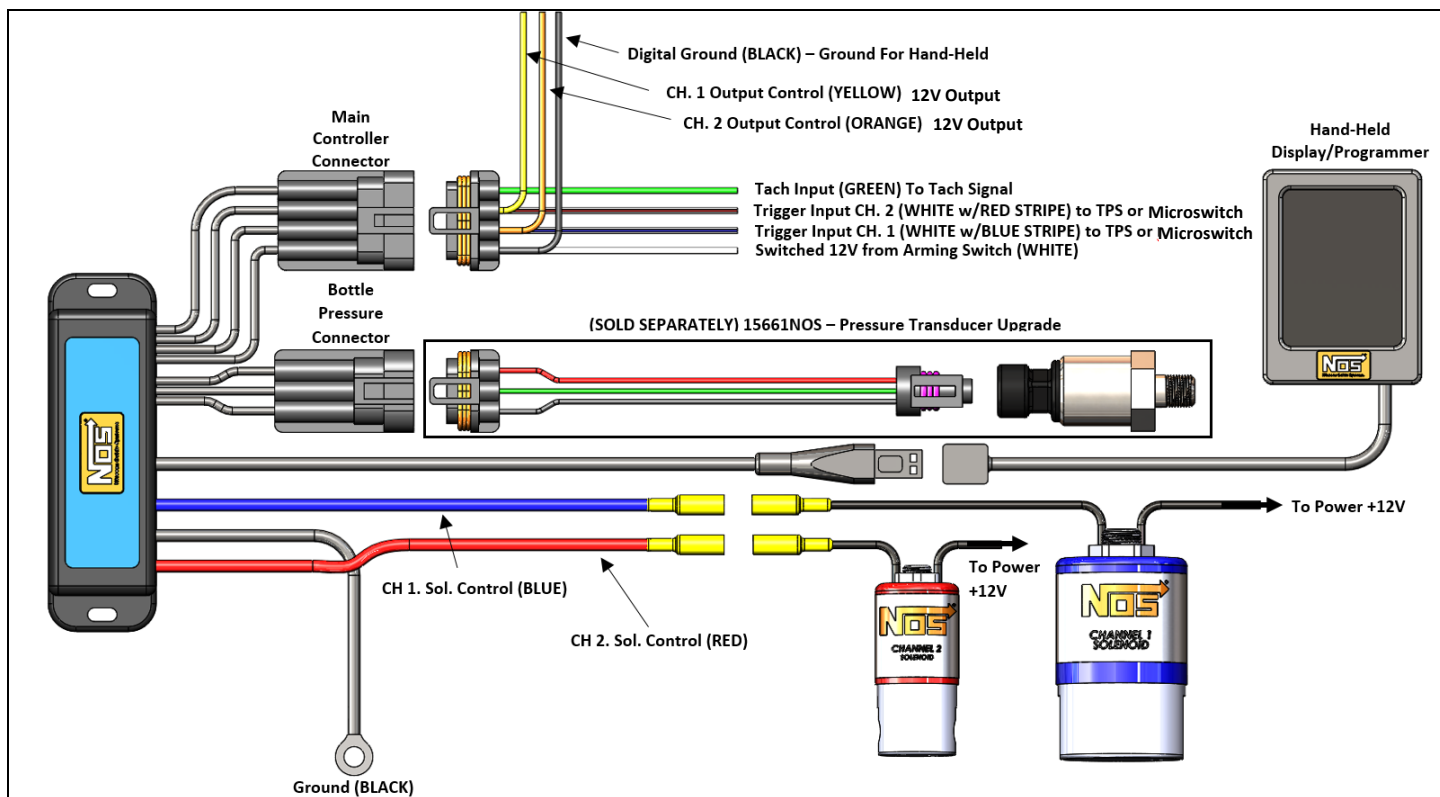

The NOS Mini 2-Stage Progressive Nitrous Controller accepts most tach signals, including low-voltage and irregular signals. Each channel can drive a fuel or nitrous solenoid progressively. The Throttle Position Activation Switch (TPAS) accepts all analog throttle position sensor signals as well as a “hot” or “grounded” wide-open-throttle (WOT) switch. Both channels have their own programmable parameters, as well as their own control output for triggering extra functions, such as ignition retard. Each channel’s internal TPAS can be configured to prevent it from activating, unless you are at WOT. Solenoid pulse frequency is also adjustable to allow the use of different types of solenoids.

GROUNDS:

Proper grounding is essential to a microprocessor controlled progressive nitrous controller. The controller has two ground wires that need to be connected. Proper practice is as follows:

Ground #1 – 12 AWG black ground cable – Install this to a good chassis ground that is grounded securely to the battery as well.

Ground #2 – 18 AWG black ground wire – Install this to a “CLEAN” ground point in the vehicle.

IMPORTANT! A “clean” ground is a ground point that does not have “dirty” ground attached directly to that point. “Dirty” ground items consist of any ignition product as well as the 12 AWG black ground cable from the controller. “Clean” grounds are grounds that go to sensors or other microprocessor controlled devices. Do NOT “stack” clean grounds to the same stud/ground point that you attach “dirty” ground wires to. It is acceptable to run a single ground cable from the battery to a ground buss bar (multiple ground studs). Stack “dirty” grounds to one point/stud and attach “clean” grounds to a separate point/stud.

1. Connect the main 8-pin wiring harness to the controller.
2. Connect the **WHITE** wire to a **+12V fused switched power source**. You should install this to a circuit that has a 5A fuse and can supply two amps to the unit. If this is not available, you should install a fuse holder.
3. Connect the **GREEN** wire to the **RPM** pickup point. You will define the proper RPM conversion in the software setup. This wire can go to the typical “tach out” output found on most ignition boxes and some distributors (12V square wave). For coil-on-plug equipped vehicles, it can be connected to one of the individual coil signal wires, which is typically a ground trigger. For specific applications, consult a factory service manual. **Note: connection to a two wire coil can only be used with coil-per-cylinder ignition systems, all others must be connected directly to a dedicated tachometer output.**
4. The **WHITE/BLUE** wire is the “**Input 1 Control**” wire. This is the trigger wire **used to activate Stage 1**. Connect to either a switched 12V or ground microswitch output, or it can be connected to the signal output wire on a TPS with either a rising or falling voltage. The signal type is selected in the software configuration. If you are not sure which wire this is, consult a factory service manual.
5. The **WHITE/RED** wire is the “**Input 2 Control**” wire. This is the trigger wire **used to activate Stage 2**. Connect to either a switched 12v or ground microswitch output, or it can be connected to the signal output wire on a TPS with either a rising or falling voltage. The signal type is selected in the software configuration. If you are not sure which wire this is, consult a factory service manual. **NOTE: CH. 1 & CH. 2 trigger input wires can be used together or separate on the TPS sensor.**
6. The **YELLOW & ORANGE** wires are General Purpose Outputs (GPO’s) that are programmable in the software for various purposes, such as activating a timing retard, etc. These have different programmable output that can be set within the Controllers settings. The **YELLOW = Stage 1 Output** and the **ORANGE = Stage 2 Output**. If these wires will not be used, heat shrink the end and secure it tightly out of the way. **WARNING! These are 12V outputs, which are limited to a 1 amp current limit. If attaching a device which requires a greater than 1 amp, use a relay.**
7. The 12 AWG **BLUE & RED** wires are the **solenoid ground outputs**. The system works by providing a ground to the solenoids. These wires are to be connected directly to the solenoids. Power must be supplied separately to the solenoids by utilizing an appropriate relay. **BLUE = Stage 1 Solenoid Ground Output, RED = Stage 2 Solenoid Ground Output. NOTE: These channels have a max current rating of 40 AMPS.**
8. The 3-pin connector on the main controller is for an optional nitrous pressure transducer input P/N 15661NOS, this kit includes the pressure sensor transducer and cable and is sold separately. Install the sensor at the bottle and plug into the harness. Pin-out as follows, A = Ground, B = Signal, C = 5 Volts. **Note: this input has a fixed calibration for using the Holley 1600 psig transducer (P/N 15661NOS or 554-104)**
9. The 4-pin connector is for the hand-held display.

Connecting the NOS Mini 2-Stage Progressive Nitrous Controller to the Touchscreen LCD

Connect the NOS Hand-held to the main harness. This is a simple plug and play connection. If you are going to permanently leave the hand-held in the vehicle, you will need to find a factory grommet in your firewall to pass the Display CAN bus connect through and secure the excess wire away from hazards. If no factory grommets can be utilized we recommend installing one purchased online or from your local auto parts store.

Note: If the touch screen LCD display needs to be unhooked from the NOS Mini 2-Stage Progressive Nitrous Controller, depress the lock tab on the male side of the connector as shown in the following images.



Unused Wires

As you finish the installation of your NOS Mini 2-Stage Progressive Nitrous Controller you may have unused wires. These wires need to be properly taken care of before installation is considered complete. The preferred option is to remove them from the connector and insert a weather proof plug in their place. The second option is to shorten the wire and properly seal the end of it to prevent shorting out.

Option 1: Pin Removal (Recommended Method)

Required tools:

Small flat head screw driver
Pin removal tool # 567-101

Procedure:

1. Use a small screwdriver or other prying tool to gently remove the protective cover from the back of the connector. NOTE: Be careful not to over extend the tabs on the cover or it will not securely fasten during reinstallation.
2. Gently insert # 567-101 removal tool into the small slot above the pin on front of the connector. It should not require much force and you should feel the tool bottom out solidly in the connector after roughly 1/4".
3. With the removal tool still inserted fully in the cavity gently pull on the wire to remove it.
4. If you will not be putting a sealed wire back in the cavity then you should now install one of the cavity plugs supplied with tool 567-101.
5. Re-install protective cover on back of connector.

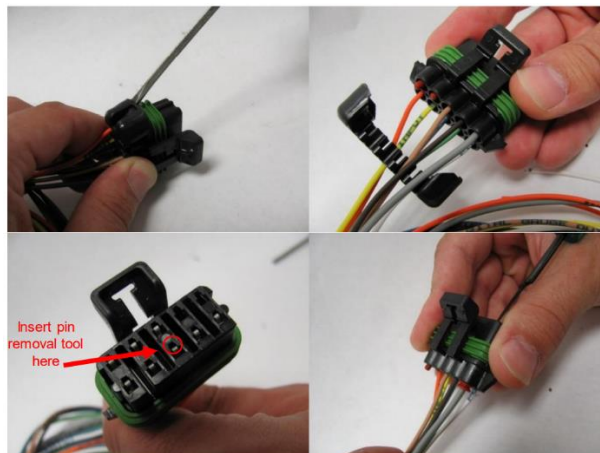

Option 2: Trim and Wrap Wire

Required tools:

Wire cutters
Adhesive heat shrink tubing
Heat source (heat gun or other)

Procedure:

1. Disconnect the battery terminals.
2. Cut the end of the wire so there are no bare copper wires showing. **NOTE: Make sure you leave enough length on the wire that you will have room to crimp or solder it at a later date should the need arise.**
3. Place a piece of adhesive lined heat shrink roughly 1" long over the wire.
4. With the heat shrink tubing placed so it is covering the wire with two thirds of its length, apply heat to shrink the tubing.
5. Give the heat shrink a small pull to verify that it is solidly attached.

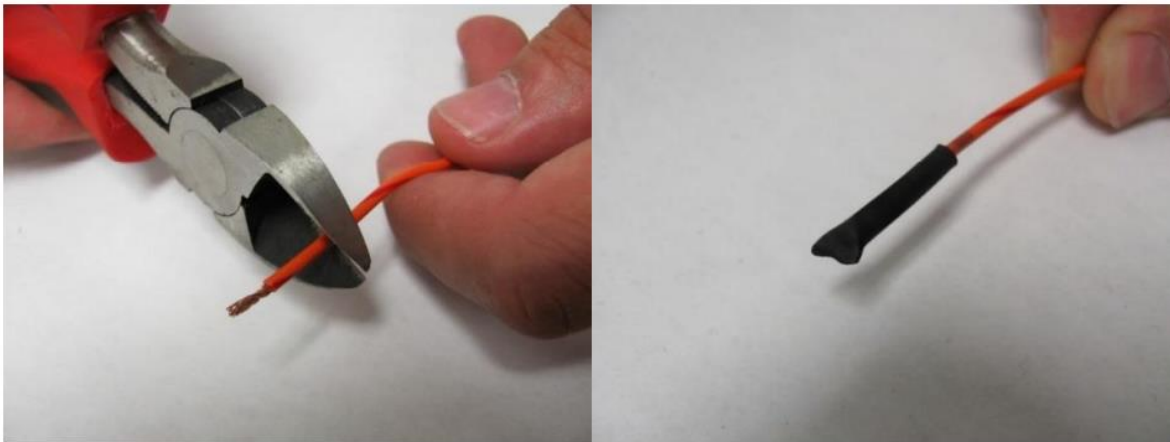

Chapter 3 Hand-Held Setup

3.1 Home Screen

The main screen of the NOS Mini 2-Stage Progressive Nitrous Controller displays the engine RPM, Bottle Pressure (if equipped), Stage 1 & Stage 2 activation RPM via colored bars (Blue = Stage 1, Yellow = Stage 2), and Stage 1 & Stage 2 ON/OFF display (ON is only displayed when the solenoids are actively being triggered).



The Gear  to the top right corner allows you to enter the main menu to begin the system setup process.



The bottle pressure display can be turned on or off in the dash setup menu. To allow for quick glances we've color coded the bottle pressure display as follows:

- White** = Bottle Pressure Very Low – 0-800 psi
- Yellow** = Bottle Pressure Low 801-900 psi
- Green** = Bottle Pressure Optimal 901-1000 psi
- Red** = Bottle Pressure too High – 1001+ psi

3.2 Main Menu

By selecting the gear icon  at the top right corner, you will be directed to the main menu screen. Here you can select from the menu items. Selecting the  will take you back to the home screen.

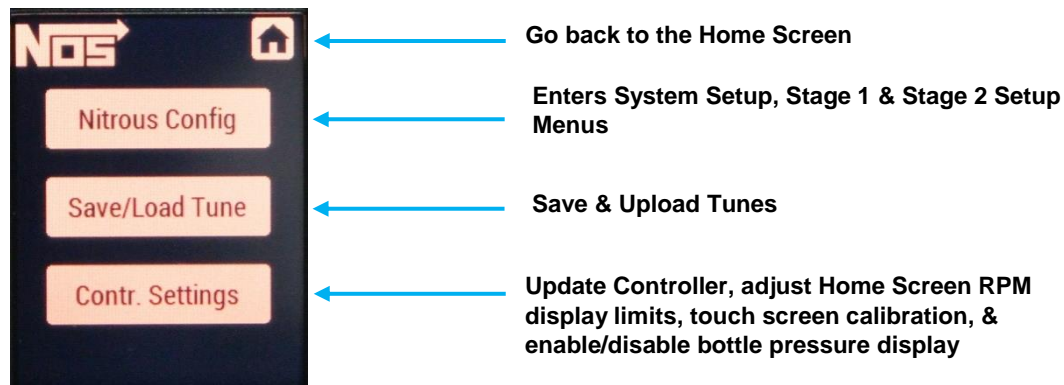

3.3 Nitrous Configuration

In the Nitrous Configuration menu you will be presented with a choice of three menus. System Setup, Stage 1, & Stage 2. **Note: The controller will be loaded with default values and both stages will be deactivated. These are only placeholders and will need to be configured.**

3.3.1 System Setup – RPM Signal

System setup allows you to select the type of RPM signal and set up the TPS via the TPS Autaset app. The NOS Mini 2-Stage Progressive Nitrous Controller supports the following RPM Signals:

- Individual Coil per Cylinder (Coil on Plug)
- Coil packs that fire in pairs (Waste Spark /Dual Outlet Coil Pack Systems) – **Note:** Use this setting to expand the RPM range higher than 9900. For example, on a 4 cylinder motorcycle, this will allow for a higher maximum RPM window. In this mode, the control can be set at 3000 and 6000 which will activate at 6000 and 12000. (This can only be done if the application is NOT a waste-fire ignition system).
- 2-12 cylinder engines, when the tach wire is connected to the tach from the engine electronic controller or distributor e.g. a cd ignition system or a conventional coil/distributor setup – This would be the 12V square wave tach output on a MSD box or a GM HEI.

NOTE: The controller's RPM signal input can be connected directly to the negative side of a coil on an "inductive" style ignition. Only connect to the negative side of the coil on a coil-per-cylinder application. Do not use on a single coil V8 or V6.

NOTE: Refer to the factory service manual to identify which style ignition system the vehicle has for proper wire connection.

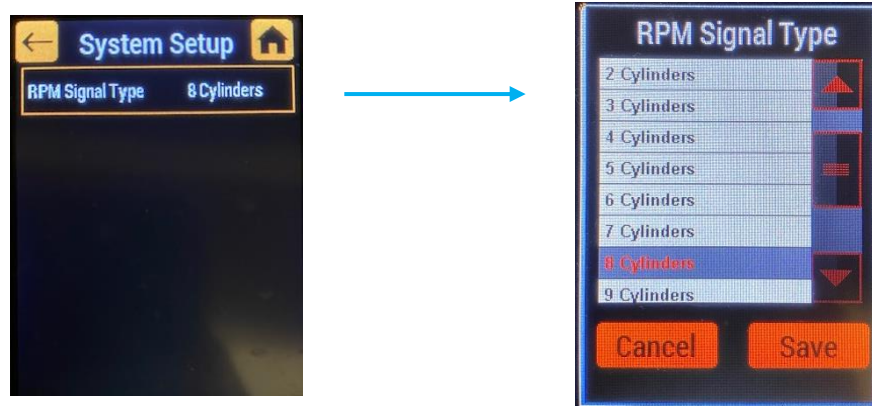

3.4 Stage 1 & Stage 2

These menus allow you to configure the different stages of the nitrous system. Within the Stage 1 Menu, you will find the Setup, Graph, & the Configuration Menus. **NOTE: Stage 2 menus are identical to stage 1. Stage 2 can be used to control a second nitrous solenoid or a fuel solenoid.**

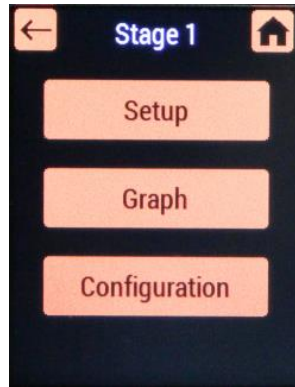

Configure Stage Activation Parameters, Run TPS Autosest & Enter Ramp Builder App.

Display/Edit Stage Graph

Display/Edit Stage Output, TPAS Mode, Ramp/Pause Mode, & PWM Frequency.

3.4.1 Setup

The setup menu contains the settings which allow you to enable or disable the stage, adjust activation and deactivation RPM, and enter the Ramp Builder App.

- **Enable/Disable Stage** – When a stage is disabled, the stage will no longer activate – the bar displayed on the RPM gauge will be removed and the menu selections for the stage will also be removed until the stage is reactivated. **Note: Both stages will be disabled by default.**
- **Activation/Deactivation RPM** – Allows you to enter the activation and deactivation RPMs. These can be adjusted via the arrow buttons or if you press on the number itself, you can manually enter any desired number from 0-15,000 RPM.
- **Ramp Builder** – The Ramp Builder App allows you to easily create a linear curve which the controller will use to progress the entry of nitrous/fuel to the engine. You must enter Start %, End %, Delay Time, Ramp Time, & Stage Duration for the controller to create the curve.
- **TPS Autosest** – Allows the controller to read and set the min and max voltage of the throttle body which is used to activate the nitrous/fuel stage.



Enable/Disable Stage

Stage Activation RPM

Stage Deactivation RPM

Enter Ramp Builder App

Enter TPS Autosest App



Adjust RPM via arrow buttons or manually enter RPM from 0-15000 RPM

For Manual Entry Press Number

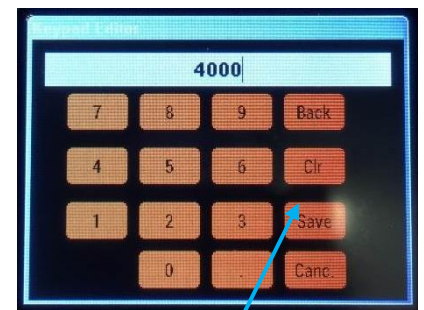

Enter number and press SAVE when complete. CLR will clear the existing number, Back will erase one digit at a time, and Canc. will back out from the screen with no changes.

3.4.2 Ramp Builder

The Ramp Builder App, allows you to easily create a linear curve which the NOS Mini 2-Stage Progressive Nitrous Controller will use to progressively introduce the nitrous/fuel into the engine. The controller will need the following information to properly generate the curve.

- **Start %** – Percent of initial solenoid activation. This controls the amount of nitrous or fuel which is introduced into the engine at the beginning of the stage. **Note: The Start % can be more or less than the End %**
- **End %** – Percent of solenoid activation at the end of the ramp. This controls the amount of nitrous or fuel which is introduced into the engine at the end of the stage. **Note: The End % can be more or less than the Start %**
- **Delay Time** – Time, in seconds that the controller delays nitrous activation after all conditions are met. This can be used to tailor power delivery to activate when the power can be used most effectively (i.e., delay the nitrous until after launching, etc.)
- **Ramp Time** – Time, in seconds that the ramp builds to the End %. The more time added here, the “Softer” the stage activation will become. 0 seconds here will fully activate the stage all at once – settings such as start % and end % will become invalid and not used.
- **Stage Duration** – Time, in seconds that the stage will be active for after the activation conditions are met. This can be adjusted from 0 to 300 seconds.

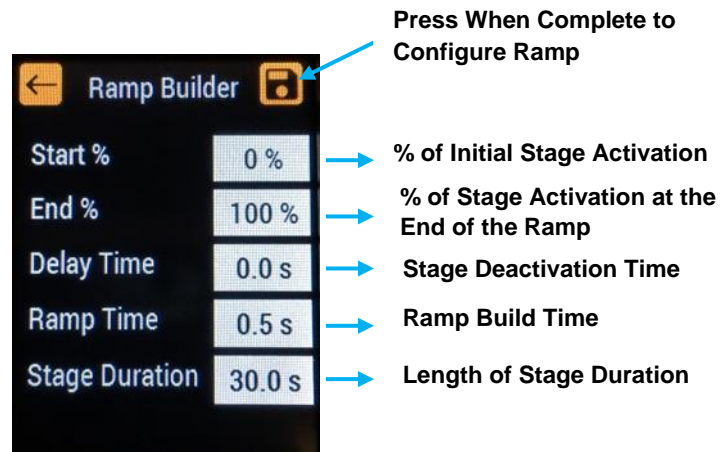

3.4.3 TPS Autaset

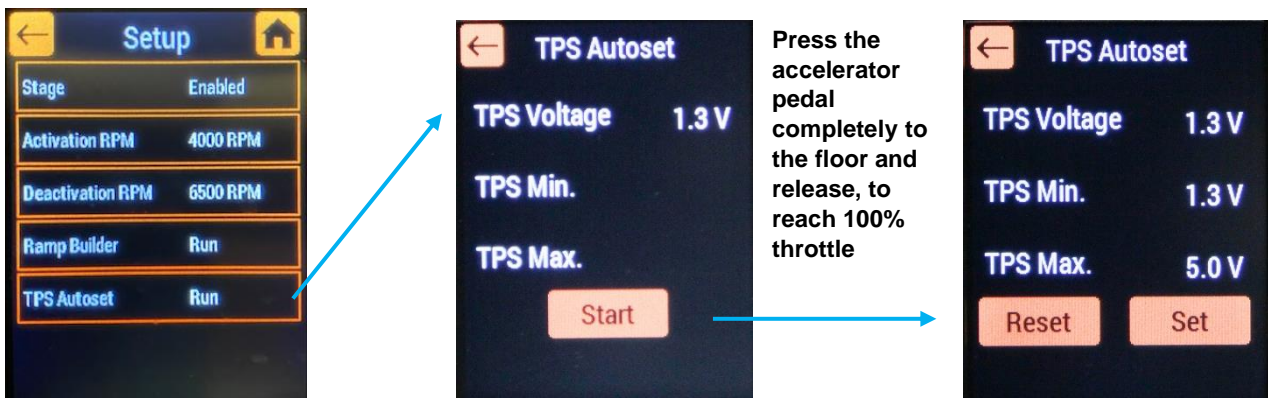

This menu can only be accessed if the vehicle's accessory power is activated, but the engine is not running. Click on TPS Autaset which is found in the **SETUP** menu of each Stage. **Note: Each stage will need to have the TPS Autaset configured individually.** Notice the TPS voltage display at the top, this is the voltage when the throttle body is in its resting state. Click on the start button. Momentarily press the accelerator pedal completely to the floor and release, to reach 100% throttle – the unit only needs to see WOT (wide open throttle) briefly to configure the WOT voltage.

NOTE: Depending on which wire you chose or the type of TPS signal you have, the voltage may rise from a low number (0.5V) to a high number (4.6V) or vice versa. The TPS Autaset App will automatically recognize this and adjust the activation threshold.



3.4.4 Graph

The Stage 1/Stage 2 graph displays a visual of the curve the controller will use to progress the nitrous/fuel solenoids. The Ramp Builder App. will generate a linear curve based on your inputs and display it in graph menu. Using the arrows, you can select 15 different points and manually slide them up and down to create your own curve. **NOTE: NOS recommends only advanced users use this feature as improper tuning can result in engine damage.** Displayed in the lower right hand corner will be the time and Duty Cycle % of the currently selected point – use this as a guide to dial in the curve. If a high degree of accuracy is required simply quickly double tap the Stage 1/Stage 2 text and a “Fine Tune Menu” will appear.

When complete, press the  save button. If you made a mistake or do not want to save, press the  back button to exit the graph without saving.

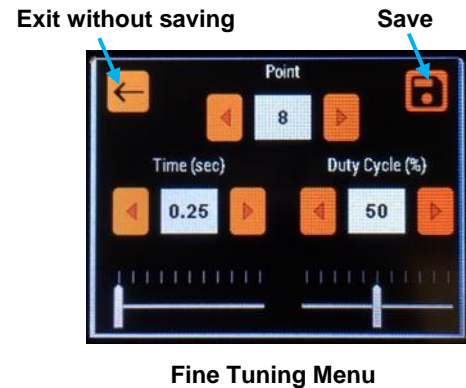
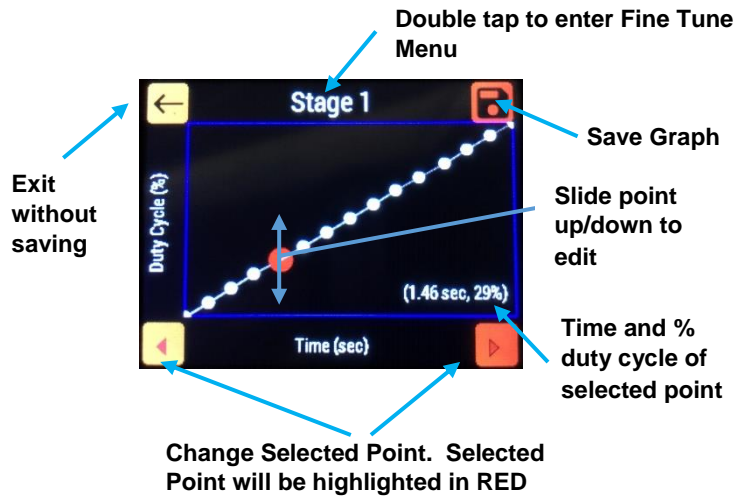

Use arrows to change values or press on the number to enter the manual entry.

3.4.5 Configuration

The configuration menu will allow you to adjust the following settings.

- **PWM Frequency** – This is the frequency at which the solenoids are driven. This is adjustable from 10 to 50 Hz. **NOS recommends a default setting of 20 Hz for most of our solenoids and 15Hz for the 18178NOS & 18178BNOS.** If using another brand of solenoids, check for their recommended frequency.
- **Ramp/Pause Mode** – This allows the controller to either reset or resume the progressive ramp that has been programmed. In reset mode, the ramp will start over from the beginning when the trigger has been deactivated and reapplied. In resume mode, once the trigger is deactivated and reapplied, the ramp will return to the last point that the system was active and continue the ramp from that point.
- **TPAS Mode** – Throttle position activation switch mode. Changes the type of throttle input. Choose from the following:
 - WOT to GND – Switches when a ground signal is applied, commonly used with a WOT microswitch.
 - WOT to 12V – Switches when a 12V signal is applied.
 - TPS to 90% - Used with Throttle Position Sensors.
 - Disable – Turns off the throttle input and only activates the stage based off RPM.
- **Control Output Delay** – The time (in seconds) the controller waits before turning on the control output **NOTE:** This output is useful when using a timing retard, activation switch, or any other switch, which requires an input.

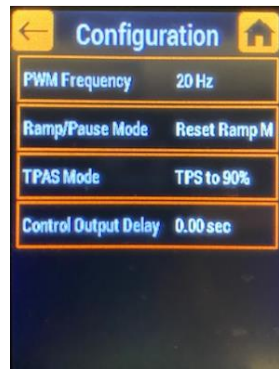

Change the frequency at which the solenoids are driven

This allows the controller to either reset or resume the progressive ramp that has been programmed.

Throttle position activation switch mode – changes the type of throttle input.

The time (in seconds) the controller waits before tuning on the control output

3.5 Save/Load Tune

The NOS Mini 2-Stage Progressive Nitrous Controller has the ability to store tunes. For custom tunes, simply configure your tune using the steps shown above. Insert a micro SD card into the slot on the hand-held and save. The NOS Engineering Team has prepared tunes which are available on the product page of the vehicle specific kit that you purchased and come preloaded on the included SD Card. These tunes are preset to deliver the optimum performance while maintaining safe operating conditions.

To save a tune:

- Insert SD card into the SD card slot located on the side of the hand-held. NOTE: The hand-held will automatically create an NOS folder within the SD card. Inside the NOS mini folder, you will find a Firmware & Tunes folder. Alternatively, NOS provides a ZIP folder which has the folder structure pre-made and is loaded with tunes.
- Navigate to the Save/Load Tune menu located on the main menu screen.
- Press the **Save Tune** button.
- You will have the ability to save your tune with a custom name of your choosing by pressing the “**Save Tune As**” button, or you can choose to allow the software to save under the default name.
- Once complete, press OK.
- Your tune is now saved to the SD card.

Downloading Tunes from NOS:

- Visit https://www.holley.com/support/nitrous_oxide_systems/ or alternately visit the product page of your specific kit.
- Download desired tune.
- Insert SD card into computer.
- Save desired tune into the TUNES folder found on the SD card.
- If the tunes folder is not found, insert your SD card into the handheld and it will create the required folders.

To upload a tune:

- With the SD card inserted navigate to the Save/Load Tune Menu
- Select the desired tune.
- Press **upload tune**.
- Confirm your tune and press **OK**.
- Cycle the power to the NOS Mini 2-Stage Progressive Nitrous Controller.
- Your tune is now flashed to the controller and ready for use.
-

Deleting Tunes

- To delete a tune, select it in the **Save/Load Tune Menu** and press **delete**.
- The tune will be removed from the SD card.

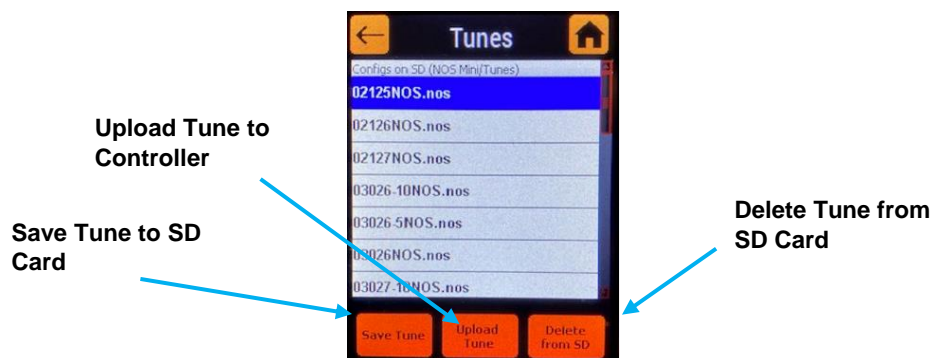

3.6 Controller Setting

The controller settings menu allows you to run the Touch Screen Calibration App, view/upload the controller firmware, and configure the main dash screen.

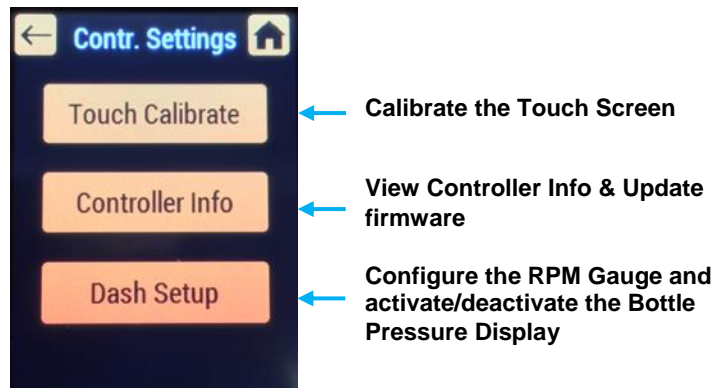

3.6.1 Touch Calibrate

If you are having issues with the touch screen not responding or selecting the wrong thing, please run the touch calibrate app. This will guide you through the process, and when successfully complete will calibrate the hand-held to more accurately sense the stylus.

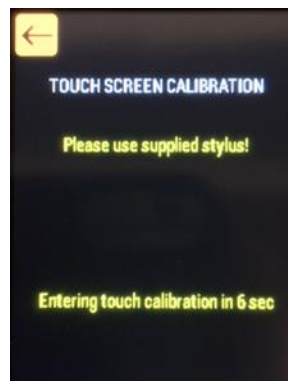

3.6.2 Controller Info/Firmware Upgrade

Controller info will display the current firmware version for both the controller and the hand-held. You can also upgrade the firmware from the SD card in this menu. The firmware for the hand-held will automatically be updated if you insert an SD card with the most recent firmware. Firmware can be downloaded at https://www.holley.com/support/resources/#Nitrous_Oxide_Systems. Download the firmware and place it in the main folder of the SD card. Insert the SD card into the slot and power on the NOS mini 2-stage. It will automatically detect the new firmware and update accordingly. To update the controller firmware, you must navigate to the Contr. Settings menu, select Controller Info, and then select update firmware. If you have more than one firmware update available, then you will have to select the latest one.

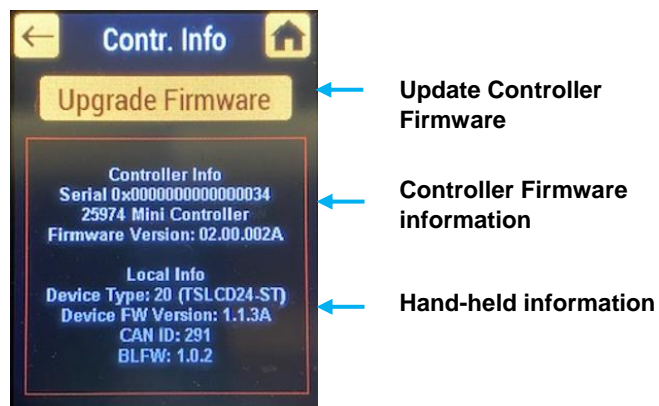

3.6.3 Dash Setup

The main screen which displays the RPM gauge and bottle pressure can be changed to suit your vehicles min and max RPM limits. If you do not have the optional 15661NOS bottle pressure transducer kit, you can disable the bottle pressure display in the dash setup menu.



- Min Tach Display on Home Screen
- Max Tach Display on Home Screen
- Enable/Disable Bottle Pressure Display

Chapter 4 – Hand-Held & Controller Firmware Update

- Download the firmware file from https://www.holley.com/support/resources/#Nitrous_Oxide_Systems
- Insert your micro SD card into your computer.
- Open the micro SD card main folder and place the most recent version of the hand-held firmware into it and safely remove the card from your computer

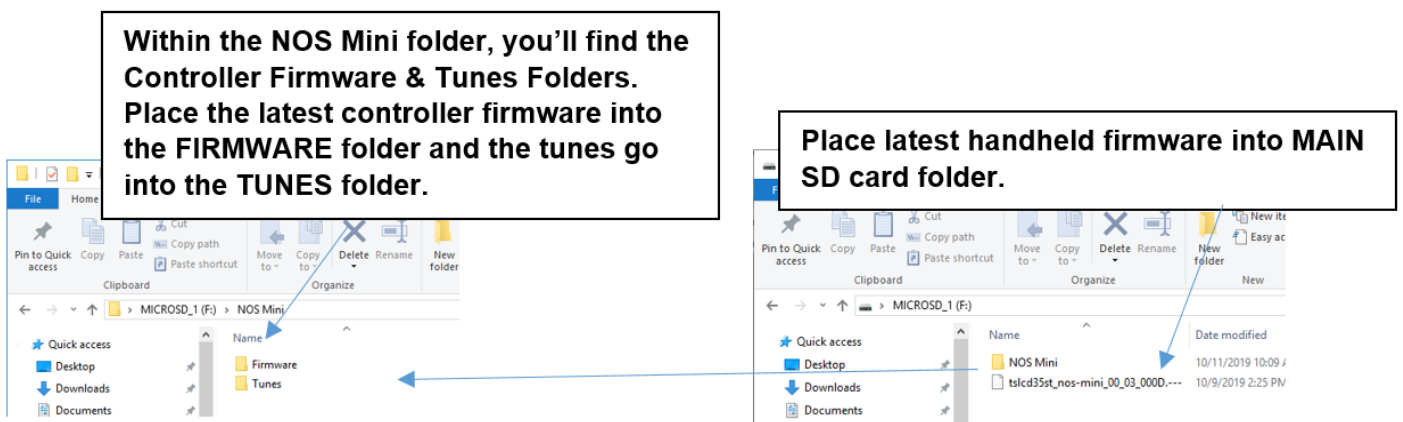

- With the hand-held powered off, insert the micro SD card into the slot located on the side of the controller.
- Once the controller is powered on, it will scan for a new software update. If found, it will automatically update the firmware to the latest version. Once complete, reboot the controller.
- To update the controller firmware, follow the above steps. However, you must navigate to the Contr. Settings menu, select Controller Info, and then select update firmware. If you have more than one firmware update available, you will have to select the latest one.



Chapter 5 – System Operation & Testing



PRESTART CHECKLIST

Before starting the engine, double check for leaks, proper wire routing, any wiring hazards, loose nuts, and bolts. This is a great time to visually inspect the overall NOS Mini 2-Stage Progressive Nitrous Controller install.

- Verify Wiring.
 - White wire is connected to a switched 12V source from the battery or fuse box
 - Small Black wire is connected to a clean ground
 - Green wire is connected to a tach signal input
 - White/Red & White/Blue wires are connected to TPS or a microswitch
 - Large Black wire is connected to a different ground than the small black wire
 - Large Red & large Blue wires are connected directly to the solenoids
 - Solenoids are powered via a 12V relay
 - Orange & yellow outputs (if used) are connected to the proper locations
- Hand-held powers up
- Nitrous parameters have been programmed and TPS Autaset along with the ramp builder have been completed
- All wiring has been tied away from potential hazards such as the exhaust, fans, and pulleys

5.1 Initial Testing & Verification

TPS Autaset (if using TPS to 90% for activation) – Before firing the engine, perform the TPS Autaset. Navigate to the TPS Autaset app located in the System Setup Menu. Press “Run” and check to see if the controller registers a TPS voltage (a drive-by-wire throttle body or throttle position sensor will see some type of voltage at the resting state). Press start and press the throttle pedal to the floor. The controller will record the voltages and save them.

First Startup – With the hand-held on the home screen, crank the engine and look for RPM. It should register and match what the engine is doing. If your engine RPM and hand-held RPM do not match, your **RPM Signal Type** is incorrect and needs to be changed.

TECHNICAL SUPPORT: 1-866-464-6553

© NOS Nitrous Oxide Systems, Inc. All rights reserved. Tous Droits Réservés.

199R11937

Revision Date: 01-29-20