



Tape On Style Window Vents



Part Numbers: 4810H

Titan - Crew 2017-2020



PUTTY KNIFE MAY BE NEEDED FOR SPECIFIC APPLICATIONS.



30-60 min



CUTTING NOT REQUIRED



DRILLING NOT REQUIRED



REMOVE CONTENTS FROM BOX. VERIFY ALL PARTS ARE PRESENT.



support@trailfx.com



READ INSTRUCTIONS CAREFULLY BEFORE STARTING INSTALLATION.



1 866 638 4870



LIMITED LIFETIME WARRANTY

Important Safety Information

- Before driving, ensure that the window vents are properly secured to vehicle.
- Do not use automatic "brush style" car washes as window vents may accidentally be pulled off the vehicle.
- Do not use cleaning solvents of any kind on the acrylic surface of the window vents to avoid accidental damage.
- Periodically check the window vents to ensure they remain securely fastened to the vehicle.

Contents - 2 Piece Set

NOTE: Actual product may vary from illustration.

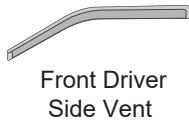

Front Driver Side Vent

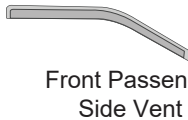

Front Passenger Side Vent



Alcohol Pad



Adhesive Promoter

Contents - 4 Piece Set

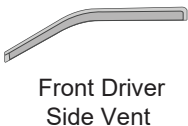

Front Driver Side Vent

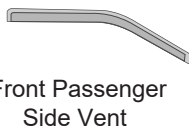

Front Passenger Side Vent

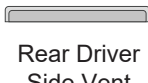

Rear Driver Side Vent

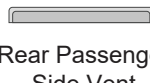

Rear Passenger Side Vent



Alcohol Pad



Adhesive Promoter

Tools Required



Car Wash Supplies



Clear Towel



Alcohol Pad



Adhesive Promoter

Preparation Before Installation

- A trial fit is recommended to ensure proper positioning and fit.
- Check fit of parts before painting as we will not accept the return of modified or painted parts.
- Wash your vehicle to remove any dirt or grime from the area where the hood protector will be attached and dry thoroughly with a clean towel.

INSTALLATION STEPS

NOTE: Actual application may vary slightly from illustrations.

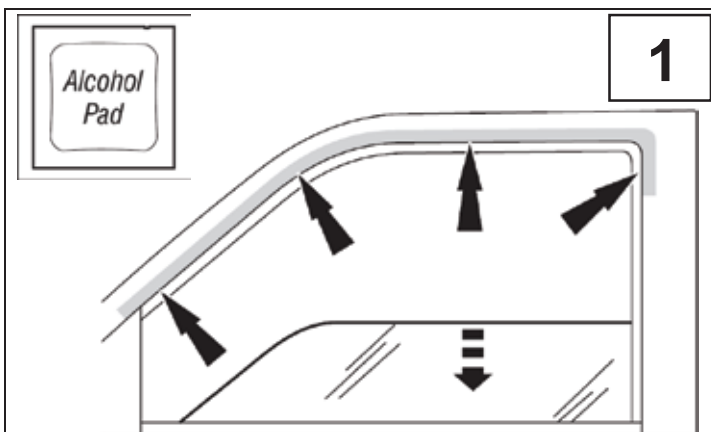

Lower the window. Clean the door's painted surface where the visor will attach.

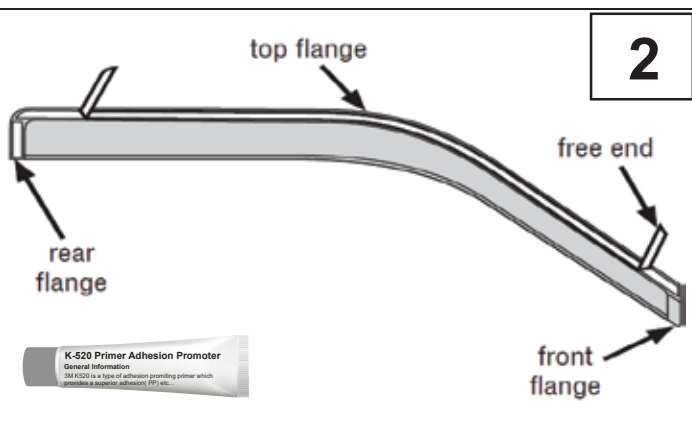

Remove the tape liner from the rear flange. Peel back 2" of tape liner from each end of top flange. Lightly apply adhesion promoter to the tape area which has been exposed from removing the tape liner and let dry (approximately 1 minute)

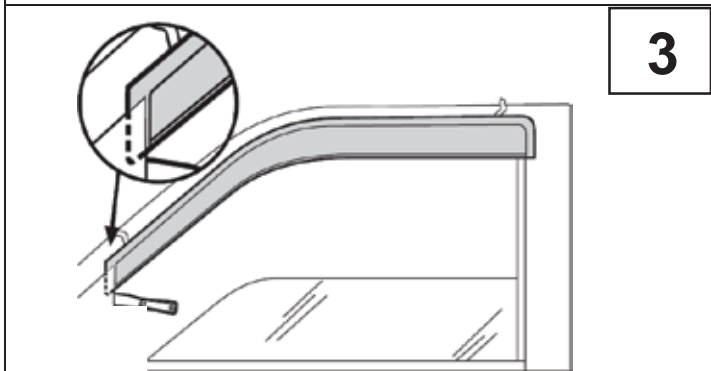

Slide the front flange behind the mirror cap, use a putty knife to create a gap if needed. Attach the top and rear flanges to the door's painted surface.

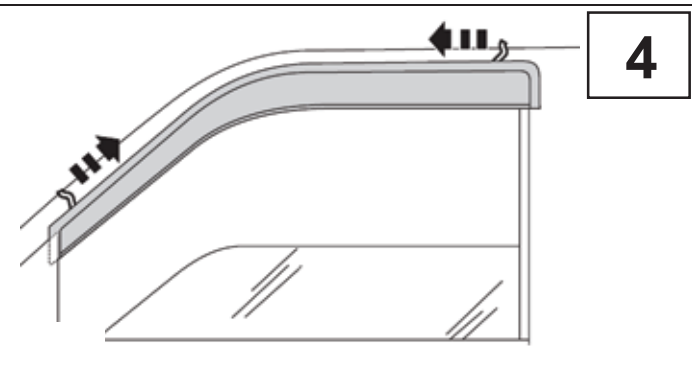

Remove tape liner by pulling on free ends. Apply pressure to top and rear tape flanges to secure. Raise the window.

4 Piece Set

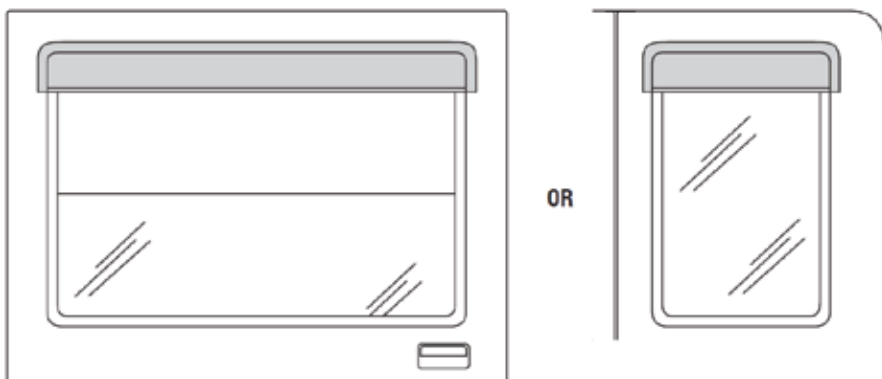

The rear visor attaches with same preparation methods as the front visor. Attach visor to the vehicle's painted surface.



Tape On Style Window Vents



Part Numbers: 4810H

Titan - Crew 2017-2020



PUTTY KNIFE MAY BE NEEDED FOR SPECIFIC APPLICATIONS.



30-60 min



CUTTING NOT
REQUIRED



DRILLING NOT
REQUIRED



REMOVE CONTENTS FROM BOX. VERIFY ALL PARTS ARE PRESENT.



support@trailfx.com



1 866 638 4870



READ INSTRUCTIONS CAREFULLY BEFORE STARTING INSTALLATION.



LIMITED LIFETIME WARRANTY



Información importante de seguridad



- **PRECAUCIÓN** - Antes de conducir, asegúrese de que la visera deflectora esté correctamente anclada al vehículo.
- No utilice servicios automáticos de limpieza de vehículos que utilizan cepillos.
- No utilice limpiadores al solvente de ningún tipo.
- Compruebe periódicamente que todos los componentes estén ajustados.

Contenido - Juego de dos piezas

NOTA: El producto real puede variar de la ilustración.

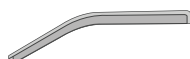

Visera del
conductor



Visera del
acompañante



Paño esterilizado



Promotora adhesiva

Contenido - Juego de cuatro piezas



Visera del
conductor



Visera del
acompañante



Visera trasera
lateral izquierdo



Visera trasera
lateral derecho



Paño esterilizado



Promotora adhesiva

Herramientas necesarias



Suministros de
lavado de autos



Toalla limpia

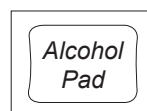

Almohadilla de alcohol



Promotora adhesiva

Preparación antes de instalar o pintar

- Se recomienda realizar un ajuste de prueba para asegurar el posicionamiento y ajuste correctos.
- Compruebe que las piezas se ajusten correctamente antes de pintarlas, ya que no aceptaremos la devolución de piezas modificadas o pintadas.
- Lave los canales de la ventanilla del vehículo para quitar los desechos y la suciedad.
- Seque los canales de la ventanilla con una toalla limpia.

Pasos de instalación

Nota: El uso real puede variar levemente de ilustraciones.

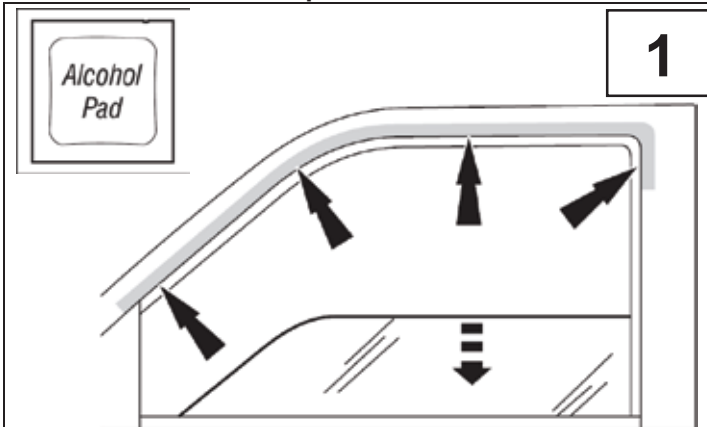

Baje la ventanilla. Limpie la superficie pintada de la puerta en donde se colocará la visera.

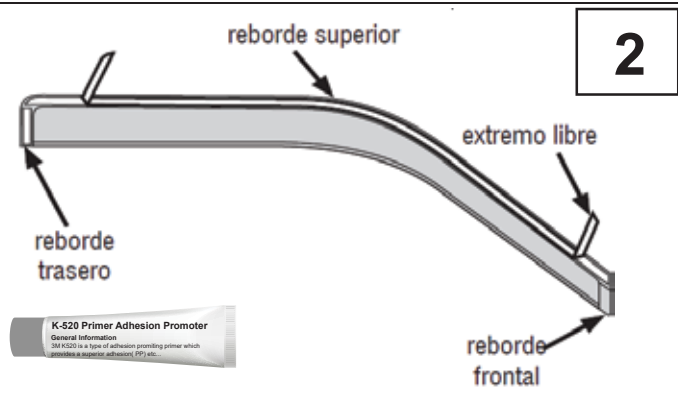

Quite la cinta protectora del reborde trasero. Retire 2 pulgs. de cinta protectora de cada uno de los extremos del reborde superior. Aplique ligeramente el promotor de adhesión en el área de la cinta que ha quedado expuesta al retirar el revestimiento de la cinta y deje secar (aproximadamente 1 minuto).

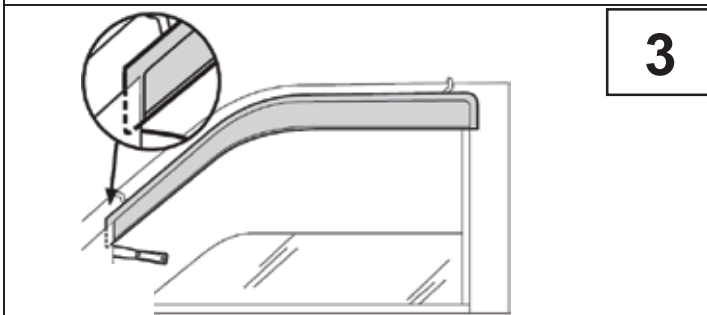

Deslice el reborde frontal por detrás de la cubierta del espejo. Si es necesario, utilice una espátula para crear el espacio. Coloque los rebordes superiores y traseros a la superficie pintada de la puerta.

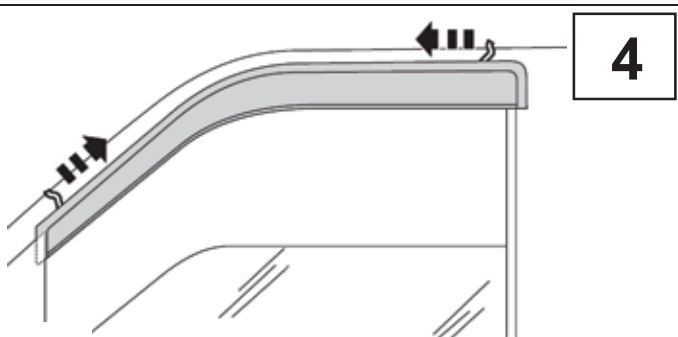

Retire la cinta protectora tirando de los extremos libres. Aplique presión sobre los rebordes de cinta superior y trasero para ajustar. Suba la ventanilla.

Juego de cuatro piezas

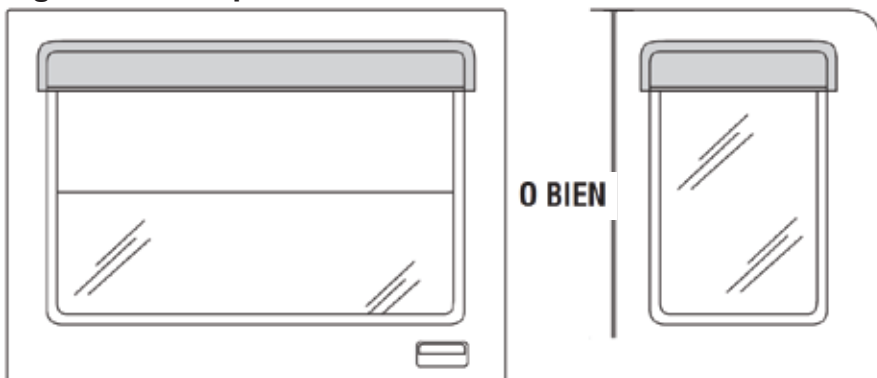

La visera trasera se coloca siguiendo los mismos pasos que para la visera frontal. Coloque la visera sobre la superficie pintada del vehículo.



Tape On Style Window Vents



Part Numbers: 4810H

Titan - Crew 2017-2020



PUTTY KNIFE MAY BE NEEDED FOR SPECIFIC APPLICATIONS.



30-60 min



CUTTING NOT
REQUIRED



DRILLING NOT
REQUIRED



REMOVE CONTENTS FROM BOX. VERIFY ALL PARTS ARE PRESENT.



support@trailfx.com



1 866 638 4870



READ INSTRUCTIONS CAREFULLY BEFORE STARTING INSTALLATION.



LIMITED LIFETIME WARRANTY



Informations importantes concernant la sécurité



- **ATTENTION – Avant de conduire, s'assurer que la visière est solidement assujettie sur le véhicule.**
- **Ne pas utiliser les stations de lavage de voitures à brosses.**
- **Ne pas utiliser de solvants.**
- **Vérifier régulièrement le serrage des composants.**

Contenu - Ensemble 2 pièces

NOTE: Le produit réel peut changer de l'illustration.

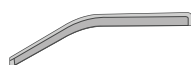

Visière avant
côte conducteur

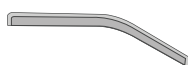

Visière avant
côte passager

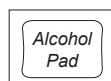

Tampons à l'alcool



Promoteur adhésif

Contenu - Ensemble 4 pièces

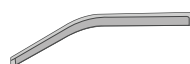

Visière avant
côte conducteur

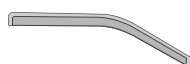

Visière avant
côte passager



Visière arrière
côté conducteur



Visière arrière
côté passager

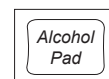

Tampons à l'alcool

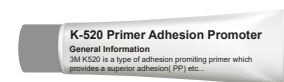

Promoteur adhésif

Outils nécessaires



Fournitures de
lavage de voiture



Serviette propre

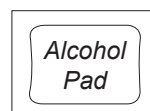

Tampon a'alcool

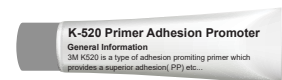

Promoteur adhésif

Préparation pour l'installation / la peinture

- *Il est recommandé de procéder à un essai pour s'assurer que le positionnement et l'ajustement sont corrects.*
- *Vérifier l'ajustement des pièces avant peinture, car nous n'acceptons pas le retour de pièces modifiées ou peintes.*
- *Laver les glissières de glaces de la portière du véhicule pour éliminer toute poussière et tous débris.*
- *Sécher les glissières avec une serviette propre.*

Étapes d'installation

NOTE: L'application réelle peut changer légèrement des illustrations.

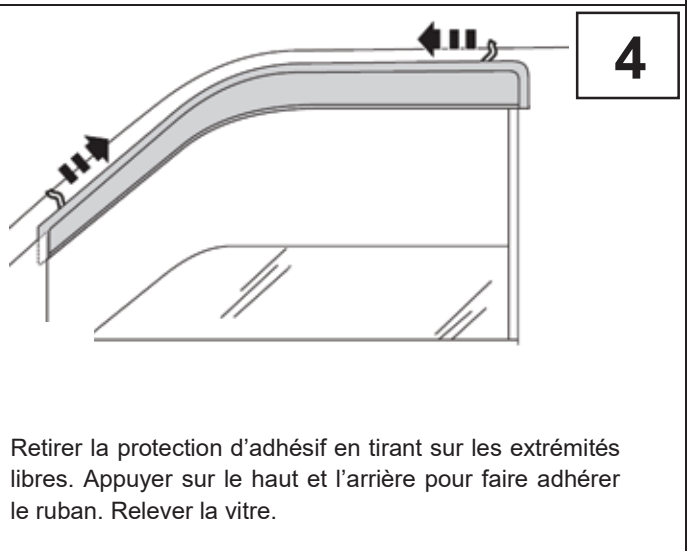
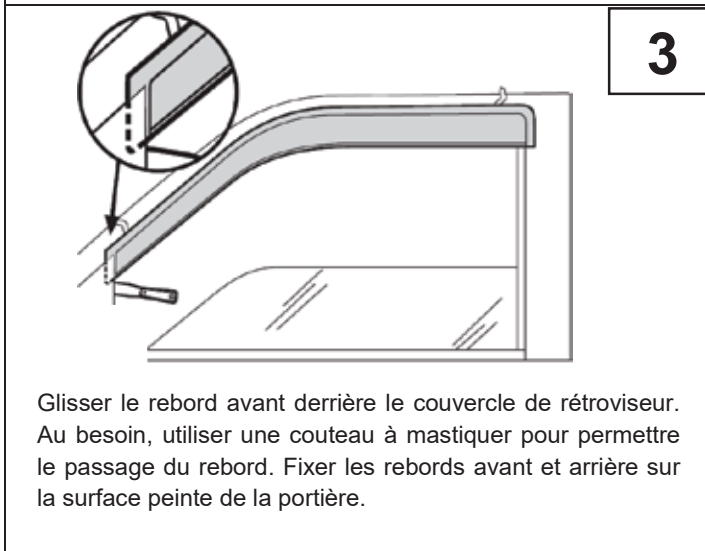
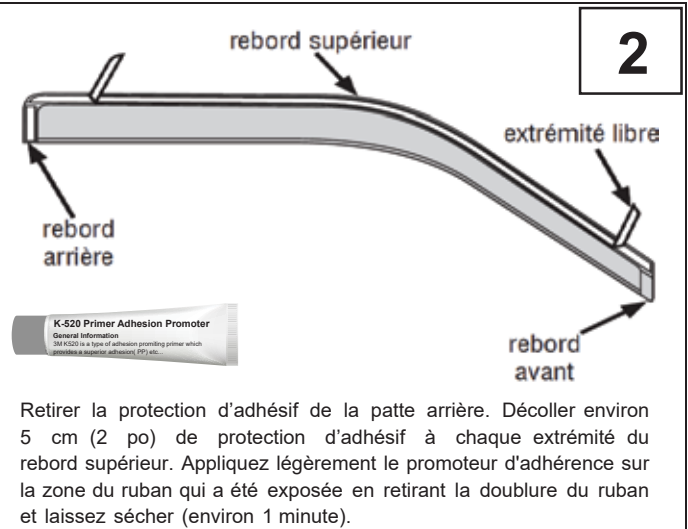
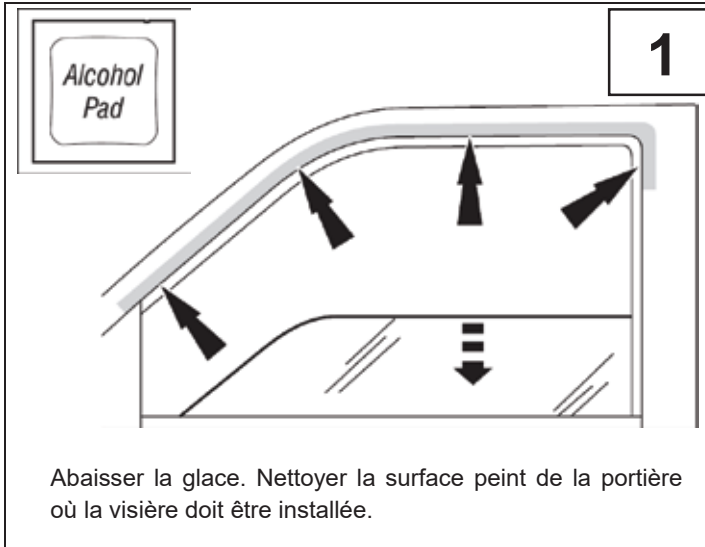

Ensemble 4 pièces

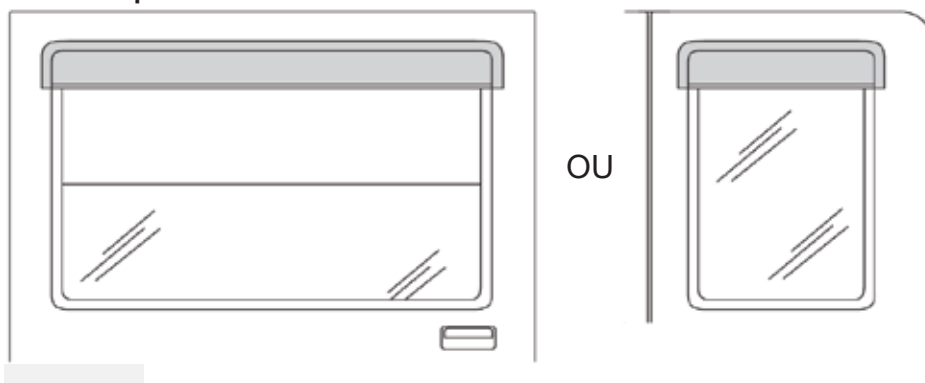

L'installation de la visière arrière demande la même préparation que la visière avant. Installer la visière sur la surface peinte du véhicule.

PRODUCT CARE

Periodically check the product to ensure all fasteners are tight and components are intact.

Check out these other TrailFX Products!!

www.TrailFX.com



HOOD SHIELDS



FENDER FLARES



STEP BARS



TONNEAU COVER

Keystone Automotive Operations Inc. (KAO) warrants this product to be free of defects in material and workmanship at the time of purchase by the original retail consumer. KAO disclaims any other warranties, express or implied, including the warranty of fitness for a particular purpose or an intended use. If the product is found to be defective, KAO may replace or repair the product at our option, when the product is returned prepaid, with proof of purchase. Alteration to, improper installation, or misuse of this product voids the warranty. KAO's liability is limited to repair or replacement of products found to be defective, and specifically excludes liability for any incidental or consequential loss or damage.