

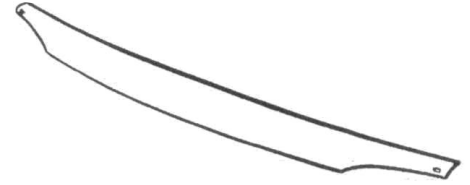

Hood Protector 4139H



Fit: 2006 - 2012 Toyota RAV4



PHILLIPS SCREW DRIVER REQUIRED FOR INSTALLATION



30-60 min



CUTTING NOT
REQUIRED



DRILLING NOT
REQUIRED



REMOVE CONTENTS FROM BOX. VERIFY ALL PARTS ARE PRESENT.



support@trailfx.com



READ INSTRUCTIONS CAREFULLY BEFORE STARTING INSTALLATION.



1 866 638 4870



LIMITED LIFETIME

Important Safety Information

- **CAUTION - Before driving, ensure that the hood shield is properly secured to vehicle.**
- **Do not use automatic “brush-style” car washes.**
- **Do not use cleaning solvents of any kind.**
- **Periodically check all components for tightness.**

NOTE: Actual product may vary from illustration.

Qty	Description	Qty	Description
01	Hood Protector	04	Protective Film
01	Alcohol Pad	01	Hardware Kit

Tools Required



Car Wash Supplies



Clean Towel



Phillips
screwdriver

Preparation Before Painting / Installation

- *A trial fit is recommended to ensure proper positioning and fit.*
- *Check fit of parts before painting as we will not accept the return of modified or painted parts.*
- *Wash and dry your vehicle to remove any debris and/or dirt from the installation area.*

INSTALLATION STEPS

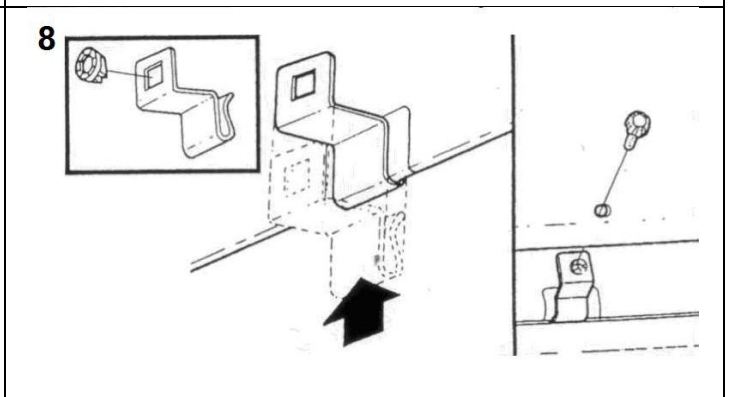
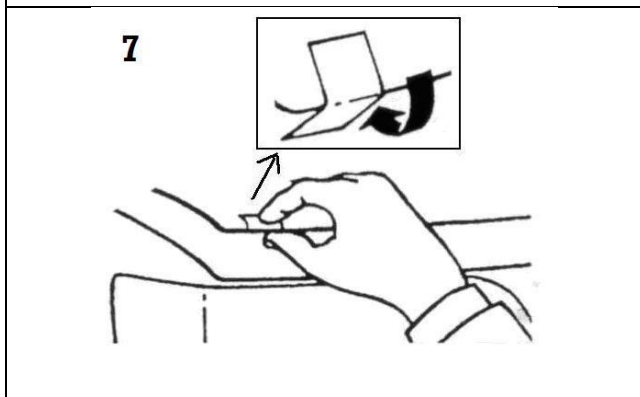
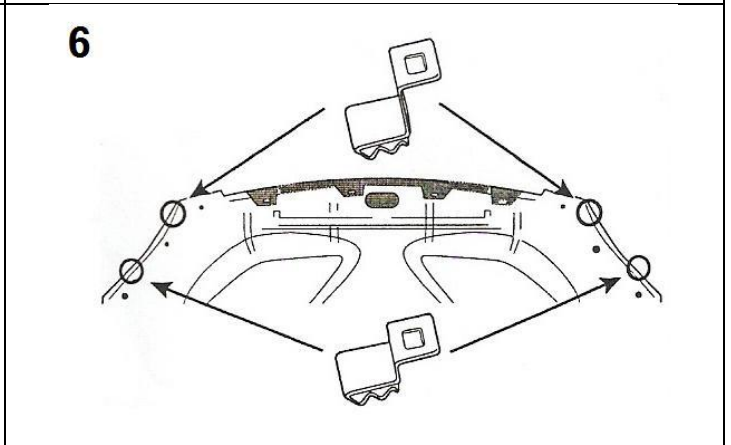
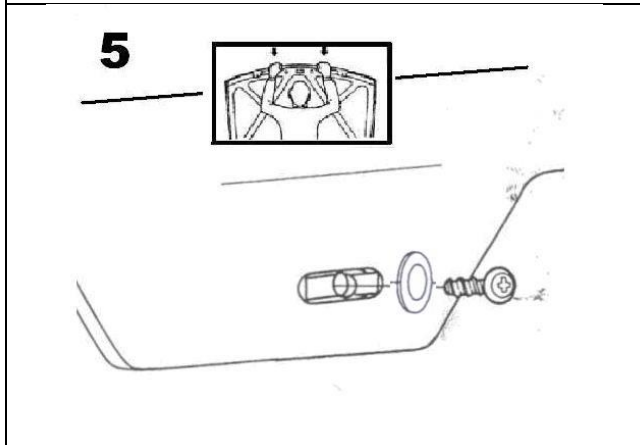
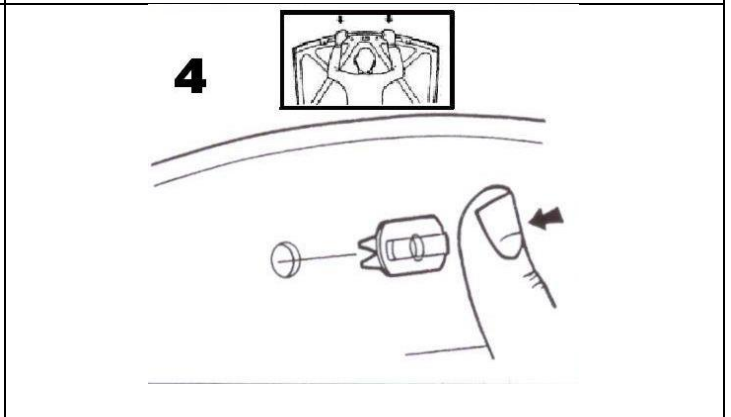
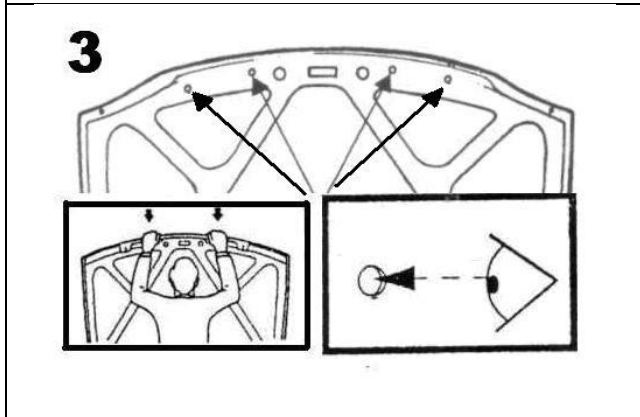
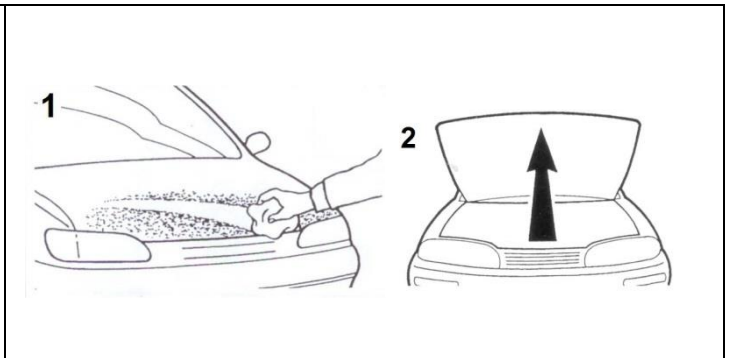
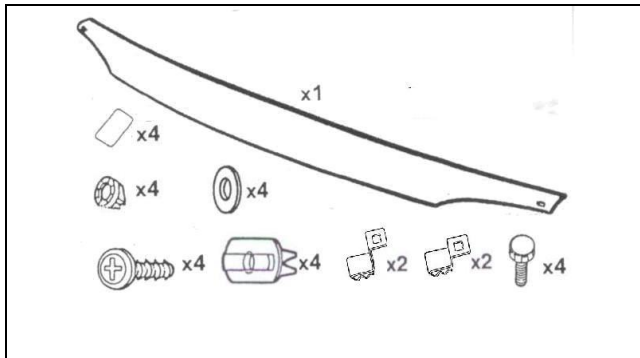

PRODUCT CARE

- Periodically check the product to ensure all fasteners are tight and components are intact.
- Regular waxing is recommended to protect the finish of the product.
- **Use ONLY Non-Abrasive automotive wax.** Use of any soap, polish or wax that contains an abrasive is detrimental and can scratch the finish leading to corrosion.

FAQ's**1. Mounting Bracket are not getting Installed properly.**

In some cases Illustration images shown in Installation manual may not be the exactly same as per actual vehicle images ,also if Driver / Passenger side mounting brackets are very identical in the design, suggest referring Parts Identification guide to avoid fitment issue.

2. Products are thumping / rattling after installation.

Please ensure that all required mounting brackets / hardware's are installed & tighten correctly. Suggest using white lithium / regular grease between the metal to metal contact surfaces.

3. Missing / Excess Hardware.

Recheck hardware count as per the part list.

4. Product not installing properly.

Ensure make model year, cab length and bed size of your vehicle is listed in the application. All installation steps are followed correctly.

Check out these other TrailFX Products!!

www.TrailFX.com



SIDE BAR

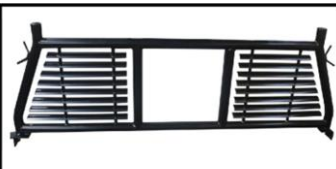

HEADACHE RACKS



RUNNING BOARDS



ROCKER GUARDS

Keystone Automotive Operations Inc. (KAO) warrants this product to be free of defects in material and workmanship at the time of purchase by the original retail consumer. KAO disclaims any other warranties, express or implied, including the warranty of fitness for a particular purpose or an intended use. If the product is found to be defective, KAO may replace or repair the product at our option, when the product is returned prepaid, with proof of purchase. Alteration to, improper installation, or misuse of this product voids the warranty. KAO's liability is limited to repair or replacement of products found to be defective, and specifically excludes liability for any incidental or consequential loss or damage.