



# Hood Protector 5126H



**FIT: 17 - ON**

**FORD ESCAPE**



PHILLIPS SCREW DRIVER REQUIRED FOR INSTALLATION



30-60 min



CUTTING NOT  
REQUIRED



DRILLING NOT  
REQUIRED



REMOVE CONTENTS FROM BOX. VERIFY ALL PARTS ARE PRESENT.



support@trailfx.com



READ INSTRUCTIONS CAREFULLY BEFORE STARTING INSTALLATION.



1-866-638-4870



LIMITED LIFETIME WARRANTY

## Important Safety Information

- Before driving, ensure that the hood shield is properly secured to vehicle.
- Do not use automatic "brush style" washes as hood protectors may accidentally be pulled off the vehicle.
- Do not use cleaning solvents of any kind on the acrylic surface of the hood protector to avoid accidental damage.
- Periodically check the hood protector to ensure it remains securely fastened to the vehicle.

**NOTE:** Actual product may vary from illustration.

Qty	Description	Qty	Description
01	Hood Protector	01	Hardware Kit
01	Alcohol Pad		

## Tools Required



Car Wash Supplies



Clear Towel



Phillips screwdriver



Alcohol  
Pad x2



Adhesive Promoter

## Preparation Before Installation

- A trial fit is recommended to ensure proper positioning and fit.
- Check fit of parts before painting as we will not accept the return of modified or painted parts.
- Wash your vehicle to remove any dirt or grime from the area where the hood protector will be attached and dry thoroughly with a clean towel.

**INSTALLATION STEPS**

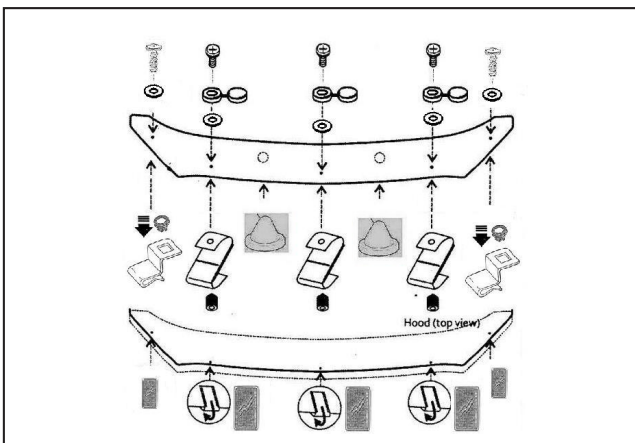
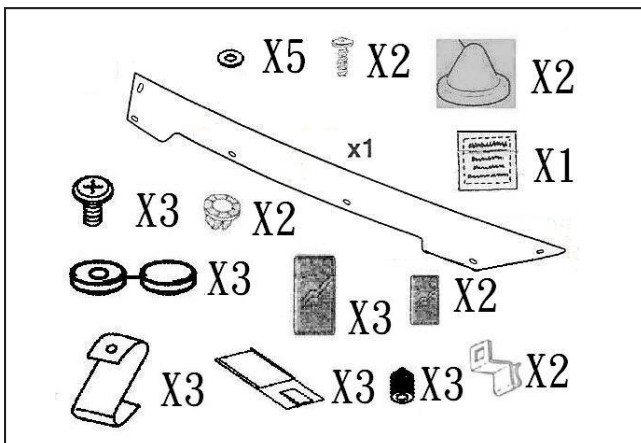

**1**

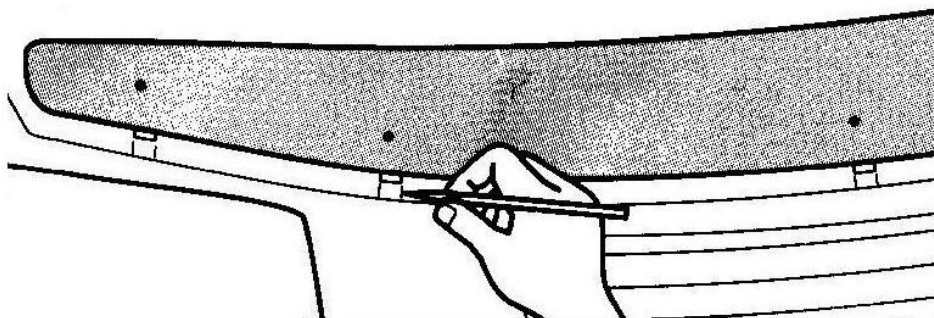

Use erasable marker or masking tape to mark on hood where retention clips need to be placed.

**2**

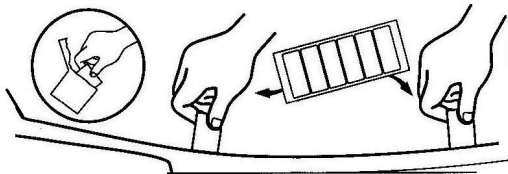

Use supplied clear paint protective strips and place on hood at marks where retention clips will be installed. Strips should be 75% on hood surface with the remaining wrapped around to the bottom lip of the hood.

**3**

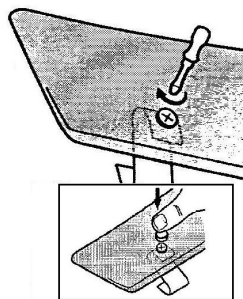

Push the three S clips onto hood centered on the clear paint protective strips. (center three clips). Double check alignment before installing hood shield to clips. Using a washer, screw holder, and screw, install hood shield to S clips.

**4**

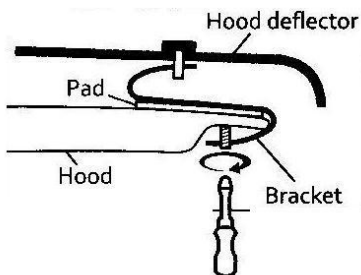

Using screw driver, tighten set screw to hold secure clip to the bottom side of the hood.

**5**

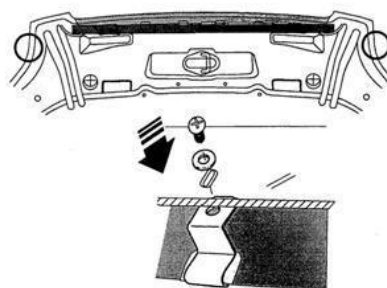

Install last two retention clips to the hood aligning with the center of the clear paint protective strips.

6

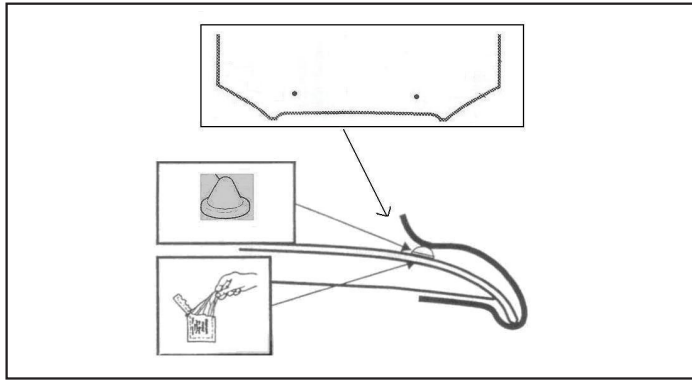

Use the supplied alcohol wipe to clean the hood area where the bump stops are to be installed. Remove the tape liner from each bump stop. Lightly apply adhesion promoter to the tape area and let dry for approximately one minute. Press bump stop into place and hold for sixty second. Repeat process for second bump stop.

### PRODUCT CARE

- Periodically check the hood protector to ensure all fasteners are tight and the hood protector is securely fastened to the vehicle.
- Wash with regular soap and water. Use of any soap, polish, or wax that contains an abrasive could lead to accidental damage.



### FAQ's

**1. Mounting Brackets are not Installing properly.**

*In some cases illustration images shown in instruction sheets may not be exactly the same depending on vehicle application. Double check all installation hardware before installation as clips may look similar but could be different and effect installation.*

**2. Missing Contents.**

*Re-check count as per the contents list / double check the box for missing items.*

**3. Product not installing properly.**

*Verify the make, model, year, and sub-model (if applicable) of your vehicle is listed as an application. Re-check all installation steps to ensure all steps were followed.*

Check out these other TrailFX Products!!

www.TrailFX.com



**WINDOW VENTS**



**STEP BARS**



**BED LINER**



**FENDER FLARES**

LKQ Specialty Products Group (LKQ) warrants this product to be free of defects in material and workmanship at the time of purchase by the original retail consumer. LKQ disclaims any other warranties, express or implied, including the warranty of fitness for a particular purpose or an intended use. If the product is found to be defective, LKQ may replace or repair the product at our option, when the product is returned prepaid, with proof of purchase. Alteration to, improper installation, or misuse of this product voids the warranty. LKQ's liability is limited to repair or replacement of products found to be defective, and specifically excludes liability for any incidental or consequential loss or damage.